

## Operating Instructions Functional Manual

DLP™ Projector Commercial Use

Model No. **PT-DZ780**  
**PT-DW750**  
**PT-DX820**

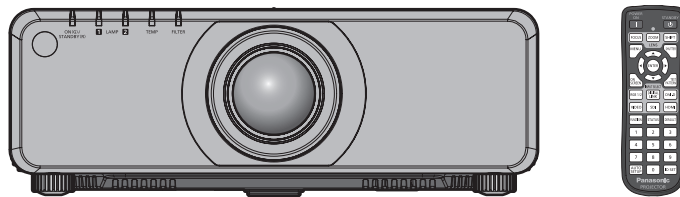

Thank you for purchasing this Panasonic product.

- This manual is common to all the models regardless of suffixes of the Model No.
  - for India
    - BD: Black model, the standard zoom lens supplied
    - WD: White model, the standard zoom lens supplied
  - for Taiwan
    - BT: Black model, the standard zoom lens supplied
  - for other countries or regions
    - B: Black model, the standard zoom lens supplied
    - W: White model, the standard zoom lens supplied
  - LBD: Black model, the lens sold separately
  - LWD: White model, the lens sold separately
  - LB: Black model, the lens sold separately
  - LW: White model, the lens sold separately
- Before operating this product, please read the instructions carefully and save this manual for future use.
- Before using this product, be sure to read “Read this first!” (➡ pages 5 to 14).



# Contents

<b>Read this first!</b> .....	<b>5</b>	<b>Projecting</b> .....	<b>62</b>
		Selecting the input signal.....	62
		Adjusting the focus, zoom, and shift.....	62
		Adjusting the lens position and focus when the fixed-focus lens (Model No.: ET-DLE030) is used.....	63
		Setting the lens position.....	63
		Adjustment range by the lens position shift (optical shift).....	64
<b>Chapter 1 Preparation</b>		<b>Operating with the remote control</b> .....	<b>66</b>
<b>Precautions for use</b> .....	<b>18</b>	Using the shutter function.....	66
Cautions when transporting.....	18	Using the on-screen display function.....	66
Cautions when installing.....	18	Switching the input.....	67
Security.....	20	Using the Status function.....	67
DIGITAL LINK.....	20	Using the Automatic setup function.....	68
Art-Net.....	20	Using the Function button.....	68
Early Warning Software.....	21	Displaying internal test patterns.....	68
Disposal.....	21	Setting the remote control ID numbers.....	69
Cautions on use.....	21		
Accessories.....	22		
Optional accessories.....	23		
<b>About your projector</b> .....	<b>24</b>	<b>Chapter 4 Settings</b>	
Remote control.....	24	<b>Menu navigation</b> .....	<b>71</b>
Projector body.....	25	Navigating through the menu.....	71
<b>Preparing the remote control</b> .....	<b>28</b>	Main menu.....	72
Inserting and removing the batteries.....	28	Sub-menu.....	73
When using the multiple projectors.....	28	<b>[PICTURE] menu</b> .....	<b>76</b>
Connecting the remote control to the projector with a cable.....	29	[PICTURE MODE].....	76
		[CONTRAST].....	76
		[BRIGHTNESS].....	76
		[COLOR].....	77
		[TINT].....	77
		[COLOR TEMPERATURE].....	77
		[WHITE GAIN].....	79
		[GAMMA].....	79
		[SYSTEM DAYLIGHT VIEW].....	80
		[SHARPNESS].....	80
		[NOISE REDUCTION].....	80
		[AI].....	81
		[SYSTEM SELECTOR].....	81
		sRGB-compliant video.....	81
<b>Chapter 2 Getting Started</b>		<b>[POSITION] menu</b> .....	<b>83</b>
<b>Setting up</b> .....	<b>31</b>	[SHIFT].....	83
Installation mode.....	31	[ASPECT].....	83
Parts for ceiling mount (optional).....	32	[ZOOM].....	84
Projected image and throw distance.....	32	[CLOCK PHASE].....	85
Adjusting adjustable feet.....	46	[GEOMETRY].....	85
<b>Removing/attaching the projection lens</b> .....	<b>47</b>		
Removing the projection lens.....	47		
Attaching the projection lens.....	47		
<b>Connecting</b> .....	<b>49</b>		
Before connecting.....	49		
Connecting example: AV equipment.....	50		
Connecting example: Computers.....	51		
Connecting example using DIGITAL LINK.....	52		
<b>Chapter 3 Basic Operations</b>			
<b>Switching on/off the projector</b> .....	<b>55</b>		
Connecting the power cord.....	55		
Power indicator.....	55		
Switching on the projector.....	56		
When the initial setting screen is displayed.....	57		
Making adjustments and selections.....	60		
Switching off the projector.....	61		
Direct power off function.....	61		

## Contents

<b>[ADVANCED MENU] menu</b> .....	<b>88</b>	<b>[PROJECTOR SETUP] menu</b> .....	<b>111</b>
[DIGITAL CINEMA REALITY] .....	88	[PROJECTOR ID] .....	111
[BLANKING] .....	88	[PROJECTION METHOD] .....	111
[INPUT RESOLUTION] .....	89	[COOLING CONDITION] .....	112
[CLAMP POSITION] .....	89	[LAMP SELECT] .....	112
[EDGE BLENDING] .....	90	[LAMP RELAY] .....	113
[FRAME RESPONSE] .....	91	[LAMP POWER] .....	113
[RASTER POSITION] .....	92	[BRIGHTNESS CONTROL] .....	114
<b>[DISPLAY LANGUAGE] menu</b> .....	<b>93</b>	[STANDBY MODE] .....	118
Changing the display language .....	93	[SCHEDULE] .....	119
<b>[DISPLAY OPTION] menu</b> .....	<b>94</b>	[INITIAL STARTUP] .....	120
[COLOR MATCHING] .....	94	[STARTUP INPUT SELECT] .....	120
[COLOR CORRECTION] .....	95	[RS-232C] .....	121
[SCREEN SETTING] .....	95	[STATUS] .....	122
[AUTO SIGNAL] .....	96	[NO SIGNAL SHUT-OFF] .....	124
[AUTO SETUP] .....	96	[REMOTE2 MODE] .....	124
[BACKUP INPUT SETTING] .....	97	[FUNCTION BUTTON] .....	124
[RGB IN] .....	98	[DATE AND TIME] .....	124
[DVI-D IN] .....	99	[LENS CALIBRATION] .....	125
[HDMI IN] .....	101	[SAVE ALL USER DATA] .....	126
[DIGITAL LINK IN] .....	102	[LOAD ALL USER DATA] .....	126
[SDI IN] .....	103	[INITIALIZE] .....	126
[ON-SCREEN DISPLAY] .....	104	[SERVICE PASSWORD] .....	127
[CLOSED CAPTION SETTING] (for NTSC or 480i YC <sub>B</sub> C <sub>R</sub> signal input only) .....	106	<b>[P IN P] menu</b> .....	<b>128</b>
[BACK COLOR] .....	106	Using P IN P function .....	128
[STARTUP LOGO] .....	107	<b>[TEST PATTERN] menu</b> .....	<b>130</b>
[UNIFORMITY] .....	107	[TEST PATTERN] .....	130
[SHUTTER SETTING] .....	108	<b>[SIGNAL LIST] menu</b> .....	<b>131</b>
[FREEZE] .....	108	Registering new signals .....	131
[WAVEFORM MONITOR] .....	108	Renaming the registered signal .....	131
[CUT OFF] .....	110	Deleting the registered signal .....	131
		Protecting the registered signal .....	132
		Expanding signal lock-in range .....	132
		Sub memory .....	133
		<b>[SECURITY] menu</b> .....	<b>134</b>
		[SECURITY PASSWORD] .....	134
		[SECURITY PASSWORD CHANGE] .....	134
		[DISPLAY SETTING] .....	134
		[TEXT CHANGE] .....	135
		[CONTROL DEVICE SETUP] .....	135
		[CONTROL DEVICE PASSWORD CHANGE] .....	136

<b>[NETWORK] menu</b> .....	<b>138</b>
[DIGITAL LINK MODE] .....	138
[DIGITAL LINK SETUP] .....	138
[DIGITAL LINK STATUS] .....	139
[NETWORK SETUP] .....	139
[NETWORK CONTROL] .....	140
[NETWORK STATUS] .....	140
[DIGITAL LINK MENU] .....	141
[Art-Net SETUP] .....	141
Network connection .....	142
Connecting to a twisted-pair-cable transmitter .....	143
Accessing from the web browser .....	144

## Chapter 5 Maintenance

<b>Lamp/temperature/filter indicators</b> .....	<b>162</b>
When an indicator lights up .....	162
<b>Maintenance/replacement</b> .....	<b>164</b>
Before performing maintenance/replacement .....	164
Maintenance .....	164
Replacement .....	166
<b>Troubleshooting</b> .....	<b>169</b>
<b>[SELF TEST] indications</b> .....	<b>171</b>

## Chapter 6 Appendix

<b>Technical information</b> .....	<b>174</b>
PJLink protocol .....	174
Using Art-Net function .....	175
Control commands via LAN .....	177
<SERIAL IN>/<SERIAL OUT> terminal .....	180
<REMOTE 2 IN> terminal .....	184
Two-window display combination list .....	185
Control device password .....	185
Upgrade Kit .....	186
List of compatible signals .....	186
<b>Specifications</b> .....	<b>189</b>
<b>Dimensions</b> .....	<b>193</b>
<b>Precautions for attaching the Ceiling Mount   Bracket</b> .....	<b>194</b>
<b>Index</b> .....	<b>195</b>

# Read this first!

**WARNING:** THIS APPARATUS MUST BE EARTHED.

**WARNING:** To prevent damage which may result in fire or shock hazard, do not expose this appliance to rain or moisture.  
This device is not intended for use in the direct field of view at visual display workplaces. To avoid incommoding reflexions at visual display workplaces this device must not be placed in the direct field of view.  
The equipment is not intended for used at a video workstation in compliance BildscharbV.

The sound pressure level at the operator position is equal or less than 70 dB (A) according to ISO 7779.

**WARNING:**

1. Remove the plug from the mains socket when this unit is not in use for a prolonged period of time.
2. To prevent electric shock, do not remove cover. No user serviceable parts inside. Refer servicing to qualified service personnel.
3. Do not remove the earthing pin on the mains plug. This apparatus is equipped with a three prong earthing-type mains plug. This plug will only fit an earthing-type mains socket. This is a safety feature. If you are unable to insert the plug into the mains socket, contact an electrician. Do not defeat the purpose of the earthing plug.

**WARNING:**

This equipment is compliant with Class A of CISPR32.  
In a residential environment this equipment may cause radio interference.

**WARNING (Australia and Newzealand):**

This is a class A product. In a domestic environment this product may cause radio interference in which case the user may be required to take adequate measures.

**CAUTION:**

To assure continued compliance, follow the attached installation instructions. This includes using the provided power cord and shielded interface cables when connecting to computer or peripheral devices. Also, any unauthorized changes or modifications to this equipment could void the user's authority to operate this device.

This is a device to project images onto a screen, etc., and is not intended for use as indoor lighting in a domestic environment.

Directive 2009/125/EC

**WARNING:** TO REDUCE THE RISK OF FIRE OR ELECTRIC SHOCK, DO NOT EXPOSE THIS PRODUCT TO RAIN OR MOISTURE.

**WARNING:** RISK OF ELECTRIC SHOCK. DON'T OPEN



Indicated on the projector



The lightning flash with arrowhead symbol, within an equilateral triangle, is intended to alert the user to the presence of uninsulated "dangerous voltage" within the product's enclosure that may be of sufficient magnitude to constitute a risk of electric shock to persons.



The exclamation point within an equilateral triangle is intended to alert the user to the presence of important operating and maintenance (servicing) instructions in the literature accompanying the product.

**Read this first!**

**WARNING:** TURN THE POWER OFF AND DISCONNECT THE POWER PLUG FROM THE WALL OUTLET BEFORE REPLACING THE LAMP UNIT.



**CAUTION (North/Middle/South America)**

**Power Supply:** This Projector is designed to operate on 100 V - 240 V, 50 Hz/60 Hz AC, house current only.

**CAUTION:** The AC power cord which is supplied with the projector as an accessory can only be used for power supplies up to 125 V. If you need to use higher voltages than this, you will need to obtain a separate 250 V power cord. If you use the accessory cord in such situations, fire may result.

**CAUTION (North/Middle/South America/Taiwan)**

This equipment is equipped with a three-pin grounding-type power plug. Do not remove the grounding pin on the power plug. This plug will only fit a grounding-type power outlet. This is a safety feature. If you are unable to insert the plug into the outlet, contact an electrician. Do not defeat the purpose of the grounding plug.

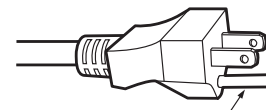

Do not remove

**WARNING (USA and Canada)**

- Not for use in a computer room as defined in the Standard for the Protection of Electronic Computer/Data Processing Equipment, ANSI/NFPA 75.
- For permanently connected equipment, a readily accessible disconnect device shall be incorporated in the building installation wiring.
- For pluggable equipment, the socket-outlet shall be installed near the equipment and shall be easily accessible.

**For USA-California Only**

This product contains a CR Coin Cell Lithium Battery which contains Perchlorate Material – special handling may apply.

See [www.dtsc.ca.gov/hazardouswaste/perchlorate](http://www.dtsc.ca.gov/hazardouswaste/perchlorate)

**NOTICE USA only:**

- This product has a High Intensity Discharge (HID) lamp that contains mercury. Disposal may be regulated in your community due to environmental considerations. For disposal or recycling information, please visit Panasonic website: <http://www.panasonic.com/environmental> or call 1-888-769-0149.

**NOTIFICATION (Canada)**

This class A digital apparatus complies with Canadian ICES-003.

**Contains mercury / Contenu avec mercure**

For more information on safe handling procedures, the measures to be taken in case of accidental breakage and safe disposal options visit:

[ec.gc.ca/mercure-mercury/](http://ec.gc.ca/mercure-mercury/).

Dispose of or recycle in accordance with applicable laws.

Pour plus de renseignements sur les procédures de manutention sécuritaire, les mesures à prendre en cas de bris accidentel et les options d'élimination sécuritaire visitez :

[ec.gc.ca/mercure-mercury/](http://ec.gc.ca/mercure-mercury/).

Mettez au rebut ou recyclez conformément aux lois applicables.

## FCC NOTICE (USA)

### Verification

Model Number: PT-DZ780B / PT-DZ780W / PT-DZ780LB / PT-DZ780LW /  
PT-DW750B / PT-DW750W / PT-DW750LB / PT-DW750LW /  
PT-DX820B / PT-DX820W / PT-DX820LB / PT-DX820LW  
Trade Name: Panasonic  
Responsible Party: Panasonic Corporation of North America  
Address: Two Riverfront Plaza, Newark, NJ 07102-5490  
General Contact: <http://www.panasonic.com/support>  
Projector Contact: <http://panasonic.net/avc/projector/>

This device complies with Part 15 of the FCC Rules.

Operation is subject to the following two conditions:

(1) This device may not cause harmful interference, and (2) this device must accept any interference received, including interference that may cause undesired operation.

### Caution:

This equipment has been tested and found to comply with the limits for a Class A digital device, pursuant to part 15 of the FCC Rules. These limits are designed to provide reasonable protection against harmful interference when the equipment is operated in a commercial environment. This equipment generates, uses, and can radiate radio frequency energy and, if not installed and used in accordance with the instruction manual, may cause harmful interference to radio communications. Operation of this equipment in a residential area is likely to cause harmful interference in which case the user will be required to correct the interference at his own expense.

### FCC Warning:

To assure continued compliance, follow the attached installation instructions. This includes using the provided power cord and shielded interface cables when connecting to computer or peripheral devices. Also, any unauthorized changes or modifications to this equipment could void the user's authority to operate this device.

## IMPORTANT: THE MOLDED PLUG (U.K. only)

FOR YOUR SAFETY, PLEASE READ THE FOLLOWING TEXT CAREFULLY.

This appliance is supplied with a molded three pin mains plug for your safety and convenience. A 13 amp fuse is fitted in this plug. Should the fuse need to be replaced, please ensure that the replacement fuse has a rating of 13 amps and that it is approved by ASTA or BSI to BS1362.

Check for the ASTA mark  or the BSI mark  on the body of the fuse.

If the plug contains a removable fuse cover, you must ensure that it is refitted when the fuse is replaced. If you lose the fuse cover, the plug must not be used until a replacement cover is obtained. A replacement fuse cover can be purchased from an Authorized Service Center.

**If the fitted molded plug is unsuitable for the mains socket in your home, then the fuse should be removed and the plug cut off and disposed of safely. There is a danger of severe electrical shock if the cut off plug is inserted into any 13 amp socket.**

If a new plug is to be fitted, please observe the wiring code as shown below.  
If in any doubt, please consult a qualified electrician.

**WARNING:** THIS APPLIANCE MUST BE EARTHED.

**IMPORTANT:** The wires in this mains lead are colored in accordance with the following code:

Green - and - Yellow: Earth  
Blue: Neutral  
Brown: Live

As the colors of the wire in the mains lead of this appliance may not correspond with the colored markings identifying the terminals in your plug, proceed as follows.

The wire which is colored GREEN - AND - YELLOW must be connected to the terminal in the plug which is marked with the letter E or by the Earth symbol  or colored GREEN or GREEN - AND - YELLOW.

The wire which is colored BLUE must be connected to the terminal in the plug which is marked with the letter N or colored BLACK.

The wire which is colored BROWN must be connected to the terminal in the plug which is marked with the letter L or colored RED.

How to replace the fuse: Open the fuse compartment with a screwdriver and replace the fuse.

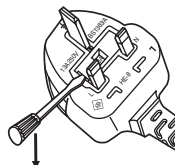

**Importer's name and address within the European Union**

**Panasonic Marketing Europe GmbH**

**Panasonic Testing Center**

**Winsbergring 15, 22525 Hamburg, Germany**



**WARNING:**

■ **POWER**

**The wall outlet or the circuit breaker shall be installed near the equipment and shall be easily accessible when problems occur. If the following problems occur, cut off the power supply immediately.**

Continued use of the projector in these conditions will result in fire or electric shock.

- If foreign objects or water get inside the projector, cut off the power supply.
- If the projector is dropped or the cabinet is broken, cut off the power supply.
- If you notice smoke, strange smells or noise coming from the projector, cut off the power supply.

Please contact an Authorized Service Center for repairs, and do not attempt to repair the projector yourself.

**During a thunderstorm, do not touch the projector or the cable.**

Electric shocks can result.

**Do not do anything that might damage the power cord or the power plug.**

If the power cord is used while damaged, electric shocks, short-circuits or fire will result.

- Do not damage the power cord, make any modifications to it, place it near any hot objects, bend it excessively, twist it, pull it, place heavy objects on top of it or wrap it into a bundle.

Ask an Authorized Service Center to carry out any repairs to the power cord that might be necessary.

**Do not use anything other than the provided power cord.**

Failure to observe this will result in electric shocks or fire. Please note that if you do not use the provided power cord to ground the device on the side of the outlet, this may result in electric shocks.

**Completely insert the power plug into the wall outlet and the power connector into the projector terminal.**

If the plug is not inserted correctly, electric shocks or overheating will result.

- Do not use plugs which are damaged or wall outlets which are coming loose from the wall.

**Do not handle the power plug and power connector with wet hands.**

Failure to observe this will result in electric shocks.

**Do not overload the wall outlet.**

If the power supply is overloaded (ex., by using too many adapters), overheating may occur and fire will result.

**Clean the power plug regularly to prevent it from becoming covered in dust.**

Failure to observe this will cause a fire.

- If dust builds up on the power plug, the resulting humidity can damage the insulation.
- If not using the projector for an extended period of time, pull the power plug out from the wall outlet.

Pull the power plug out from the wall outlet and wipe it with a dry cloth regularly.

**WARNING:**

■ **ON USE/INSTALLATION**

**Do not place the projector on soft materials such as carpets or sponge mats.**

Doing so will cause the projector to overheat, which can cause burns, fire or damage to the projector.

**Do not set up the projector in humid or dusty places or in places where the projector may come into contact with oily smoke or steam.**

Using the projector under such conditions will result in fire, electric shocks or deterioration of components. Deterioration of components (such as ceiling mount brackets) may cause the projector which is mounted on the ceiling to fall down.

**Do not install this projector in a place which is not strong enough to take the full weight of the projector or on top of a surface which is sloped or unstable.**

Failure to observe this will cause projector to fall down or tip over the projector, and severe injury or damage could result.

**Do not cover the air intake/exhaust ports or place anything within 500 mm (20") of them.**

Doing so will cause the projector to overheat, which can cause fire or damage to the projector.

- Do not place the projector in narrow, badly ventilated places.
- Do not place the projector on cloth or papers, as these materials could be drawn into the air intake port.

**Do not place your hands or other objects close to the air exhaust port.**

Doing so will cause burns or damage your hands or other objects.

- Heated air comes out of the air exhaust port. Do not place your hands or face, or objects which cannot withstand heat close to this port.

**Do not look at or place your skin into the light emitted from the lens while the projector is being used.**

Doing so can cause burns or loss of sight.

- Strong light is emitted from the projector's lens. Do not look at or place your hands directly into this light.
- Be especially careful not to let young children look into the lens. In addition, turn off the power and switch off the main power when you are away from the projector.

**Do not project an image with the lens cover attached.**

Doing so can cause fire.

**Never attempt to remodel or disassemble the projector.**

High voltages can cause fire or electric shocks.

- For any inspection, adjustment and repair work, please contact an Authorized Service Center.

**Do not allow metal objects, flammable objects, or liquids to enter inside of the projector. Do not allow the projector to get wet.**

Doing so may cause short circuits or overheating, and result in fire, electric shock, or malfunction of the projector.

- Do not place containers of liquid or metal objects near the projector.
- If liquid enters inside of the projector, consult your dealer.
- Particular attention must be paid to children.

**Use the ceiling mount bracket specified by Panasonic.**

Using the ceiling mount bracket other than the specified one will result in falling accidents.

- Attach the supplied safety cable to the ceiling mount bracket to prevent the projector from falling down.

**Installation work (such as ceiling mount bracket) should only be carried out by a qualified technician.**

If installation is not carried out and secured correctly, it can cause injury or accidents, such as electric shocks.

- Be sure to use the wire provided with the ceiling mount bracket as an extra safety measure to prevent the projector from falling down. (Install in a different location to the ceiling mount bracket.)

**WARNING:**

■ **ACCESSORIES**

**Do not use or handle the batteries improperly, and refer to the following.**

Failure to observe this will cause burns, batteries to leak, overheat, explode or catch fire.

- Do not use unspecified batteries.
- Do not use chargeable batteries.
- Do not disassemble dry cell batteries.
- Do not heat the batteries or place them into water or fire.
- Do not allow the + and – terminals of the batteries to come into contact with metallic objects such as necklaces or hairpins.
- Do not store or carry batteries together with metallic objects.
- Store the batteries in a plastic bag and keep them away from metallic objects.
- Make sure the polarities (+ and –) are correct when inserting the batteries.
- Do not use a new battery together with an old battery or mix different types of batteries.
- Do not use batteries with the outer cover peeling away or removed.

**If the battery fluid leaks, do not touch it with bare hands, and take the following measures if necessary.**

- Battery fluid on your skin or clothing could result in skin inflammation or injury.  
Rinse with clean water and seek medical advice immediately.
- Battery fluid coming in contact with your eyes could result in loss of sight.  
In this case, do not rub your eyes. Rinse with clean water and seek medical advice immediately.

**Do not disassemble the lamp unit.**

If the lamp breaks, it could cause injury.

**Lamp replacement**

The lamp has high internal pressure. If improperly handled, an explosion and severe injury or accidents will result.

- The lamp can easily explode if struck against hard objects or dropped.
- Before replacing the lamp unit, be sure to turn the power off and to disconnect the power plug from the wall outlet.  
Electric shocks or explosions can result if this is not done.
- When replacing the lamp unit, turn the power off and allow the lamp to cool for at least one hour before handling it otherwise it can cause burns.

**Do not allow children to reach the batteries.**

Accidentally swallowing them can cause physical harm.

- If swallowed, seek medical advice immediately.

**Remove the depleted batteries from the remote control promptly.**

- Leaving them in the unit may result in fluid leakage, overheating, or explosion of the batteries.

**CAUTION:**

■ **POWER**

**When disconnecting the power cord, be sure to hold the power plug and power connector.**

If the power cord itself is pulled, the lead will become damaged, and fire, short-circuits or serious electric shocks will result.

**When not using the projector for an extended period of time, disconnect the power plug from the wall outlet.**

Failure to do so may result in fire or electric shock.

**Before replacing the projection lens, be sure to turn off the power and disconnect the power plug from the wall outlet.**

- Unexpected projection of light may cause injury to eyes.
- Replacing the projection lens without removing the power plug may result in electric shock.

**Disconnect the power plug from the wall outlet before carrying out any cleaning.**

Failure to do so may result in electric shock.

■ **ON USE/INSTALLATION**

**Do not place heavy objects on top of the projector.**

Failure to observe this will cause the projector to become unbalanced and fall, which could result in damage or injury. The projector will be damaged or deformed.

**Do not put your weight on this projector.**

You could fall or the projector could break, and injury will result.

- Be especially careful not to let young children stand or sit on the projector.

**Do not place the projector in extremely hot locations.**

Doing so will cause the outer casing or internal components to deteriorate, or result in fire.

- Take particular care in locations exposed to direct sunlight or near heaters.

**Do not install the projector in a location where salt pollution or corrosive gas may occur.**

Doing so may result in falling due to corrosion.

**Do not place your hands in the openings beside the optical lens, while shifting the lens.**

Failure to observe this could cause injury.

**Do not stand in front of the lens while the projector is being used.**

Doing so can cause damage and burns to clothing.

- Extremely strong light is emitted from the projector's lens.

**Do not place objects in front of the lens while the projector is being used.**

Doing so can cause fire, damage to an object, or malfunction of the projector.

- Extremely strong light is emitted from the projector's lens.

**Always disconnect all cables before moving the projector.**

Moving the projector with cables still attached can damage the cables, which will cause fire or electric shocks to occur.

**When mounting the projector on the ceiling, keep mounting screws and power cord from contact with metal parts inside the ceiling.**

Contact with metal parts inside the ceiling can cause electric shocks.

**CAUTION:**

■ **ACCESSORIES**

**Do not use the old lamp unit.**

If used it could cause lamp explosion.

**If the lamp has broken, ventilate the room immediately. Do not touch or bring your face close to the broken pieces.**

Failure to observe this will cause the user to absorb the gas which was released when the lamp broke and which contains nearly the same amount of mercury as fluorescent lamps, and the broken pieces will cause injury.

- If you believe that you have absorbed the gas or that the gas has got into your eyes or mouth, seek medical advice immediately.
- Ask your dealer about replacing the lamp unit and check the inside of the projector.

**When not using the projector for an extended period of time, remove the batteries from the remote control.**

Failure to observe this will cause the batteries to leak, overheat, catch fire or explode, which may result in fire or contamination of surrounding area.

■ **MAINTENANCE**

**Do not touch the fan with your fingers or any other parts of your body when removing the lamp unit or the air filter.**

Doing so can cause injury.

**Ask your dealer about cleaning inside the projector once a year.**

Continuous use while dust is accumulated inside the projector may result in fire.

- For cleaning fee, ask your dealer.

**To remove the battery**

**Remote Control Battery**

**1. Press the guide and lift the cover.**

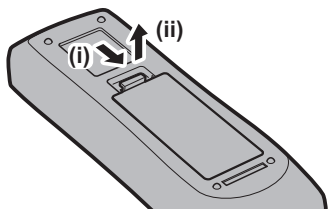

**2. Remove the batteries.**

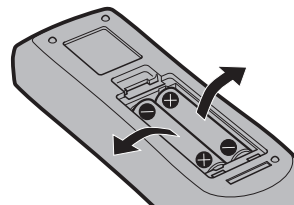

## Brazil Only Brasil Apenas

### ■ Manuseio de baterias usadas



#### BRASIL

Após o uso, as pilhas e/ou baterias deverão ser entregues ao estabelecimento comercial ou rede de assistência técnica autorizada.

Cobrir os terminais positivo (+) e negativo (-) com uma fita isolante adesiva, antes de depositar numa caixa destinada para o recolhimento. O contato entre partes metálicas pode causar vazamentos, gerar calor, romper a blindagem e produzir fogo. (Fig. 1)

**Fig. 1**  
Como isolar os terminais

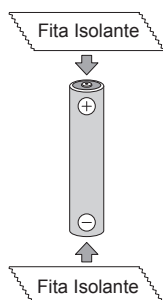

Não desmonte, não remova o invólucro, nem amasse a bateria. O gás liberado pela bateria pode irritar a garganta, danificar o lacre do invólucro ou o vazamento provocar calor, ruptura da blindagem e produzir fogo devido ao curto circuito dos terminais. Não incinere nem aqueça as baterias, elas não podem ficar expostas a temperaturas superiores a 100 °C (212 °F). O gás liberado pela bateria pode irritar a garganta, danificar o lacre do invólucro ou o vazamento provocar calor, ruptura da blindagem e produzir fogo devido ao curto circuito dos terminais provocado internamente.

Evite o contato com o líquido que vazar das baterias. Caso isto ocorra, lave bem a parte afetada com bastante água. Caso haja irritação, consulte um médico.

### ■ Remoção das baterias

1. Pressione a guia e levante a tampa.

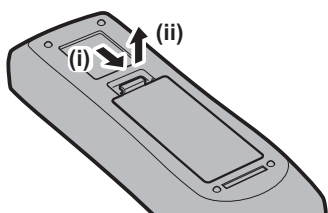

2. Remova as baterias.

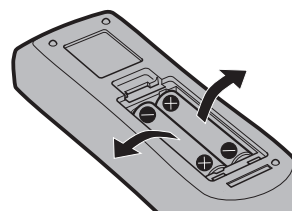

---

## ■ Trademarks

- Windows, Windows Vista, and Internet Explorer are registered trademarks or trademarks of Microsoft Corporation in the United States and other countries.
- Mac, Mac OS, OS X, and Safari are trademarks of Apple Inc., registered in the United States and other countries.
- PJLink™ is a registered trademark or pending trademark in Japan, the United States, and other countries and regions.
- HDMI, the HDMI Logo, and High-Definition Multimedia Interface are trademarks or registered trademarks of HDMI Licensing LLC in the United States and other countries.
- RoomView and Crestron RoomView are registered trademarks of Crestron Electronics, Inc. Crestron Connected™ and Fusion RV are trademarks of Crestron Electronics, Inc.
- HDBaseT™ is a trademark of HDBaseT Alliance.
- Art-Net™ Designed by and Copyright Artistic Licence Holdings Ltd
- Adobe, Adobe Flash Player, and Adobe Reader are trademarks or registered trademarks of Adobe Systems Inc. in the United States and/or other countries.
- Some of the fonts used in the on-screen menu are Ricoh bitmap fonts, which are manufactured and sold by Ricoh Company, Ltd.
- All other names, company names, and product names mentioned in this manual are trademarks or registered trademarks of their respective owners.  
Please note that the ® and ™ symbols are not specified in this manual.

## ■ Illustrations in this manual

- Illustrations of the projector, screen, and other parts may vary from the actual product.

## ■ Reference pages

- Reference pages in this manual are indicated as (➡ page 00).

## ■ Term

- In this manual, the “Wireless/wired remote control unit” accessory is referred to as “Remote control”.

## Features of the Projector

### High luminance & quietness

- ▶ With the unique optical system and unique cooling system, high luminance of 8 200 lm<sup>\*1\*2</sup> and quietness of noise level 30 dB<sup>\*2</sup> are achieved.

\*1 For PT-DX820

7 000 lm for PT-DZ780 and PT-DW750

\*2 Measurement, measuring conditions and method of notation all comply with ISO21118 international standards.

### Easy and highly flexible setup

- ▶ Easy and highly flexible setup is achieved with DIGITAL LINK compatibility, Art-Net compatibility, 3G-SDI standard support<sup>\*1</sup>, geometric adjustment function standard support, and lineup of various optional lenses.

\*1 Only for PT-DZ780

### Reduction of maintenance cost

- ▶ In addition to realizing the long life with lamp replacement recommended time of 6 000H<sup>\*1</sup>, by adopting the dustproof mechanism in the optical block contributes to reduction of the maintenance cost.

\*1 When [LAMP POWER] is set to [ECO].

## Quick Steps

For details, refer to the corresponding pages.

1. **Set up the projector.**  
(⇒ page 31)



2. **Attach the projection lens.**  
(⇒ page 47)



3. **Connect with external devices.**  
(⇒ page 49)



4. **Connect the power cord.**  
(⇒ page 55)



5. **Switch on the projector.**  
(⇒ page 56)



6. **Make initial settings.**  
(⇒ page 57)
  - Take this step when you switch on the power for the first time after purchasing the projector.



7. **Select the input signal.**  
(⇒ page 62)



8. **Adjust the image.**  
(⇒ page 62)



# Chapter 1 Preparation

---

This chapter describes things you need to know or check before using the projector.

# Precautions for use

## Cautions when transporting

- If you purchased the projector with the standard zoom lens, remove the lens cushion before use, and store it for the future use. When transporting the projector, move the lens position to the home position and attach the lens cushion.

If you purchased the projector with the lens sold separately, remove the lens hole cover before use, and store it for the future use. When transporting the projector, move the lens position to the home position, remove the projection lens, and then attach the lens hole cover.

For the steps to move the lens position to the home position, refer to “Setting the lens position” (➔ page 63).

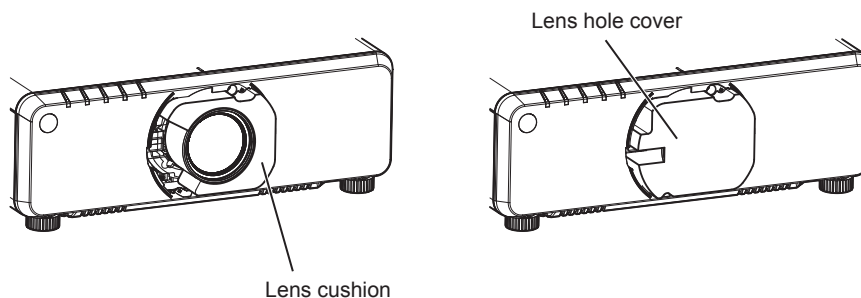

- When transporting the projector, hold it securely by its bottom and avoid excessive vibration and impacts. They may damage the internal components and result in malfunctions.
- Do not transport the projector with the adjustable feet extended. Doing so may damage the adjustable feet.

## Cautions when installing

### ■ After attaching the projection lens, be sure to attach the lens mount cover.

Otherwise dust will accumulate inside and may cause malfunctions.

### ■ Do not set up the projector outdoors.

The projector is designed for indoor use only.

### ■ Do not set up the projector in the following locations.

- Places where vibration and impacts occur such as in a car or vehicle: Doing so may cause damage to internal components or malfunction.
- Location close to sea or where corrosive gas may occur: The projector may fall due to corrosion. Also, it may shorten the life of the components and result in malfunctions.
- Near the exhaust of an air conditioner: Depending on the conditions of use, the screen may fluctuate in rare cases due to the heated air from the air exhaust port or the hot or cooled air. Make sure that the exhaust from the projector or other equipment, or the air from the air conditioner does not blow toward the front of the projector.
- Places with sharp temperature fluctuations such as near lights (studio lamps): Doing so may shorten the life of the lamp, or result in deformation of the outer case due to heat, which may cause malfunctions.  
The operating environment temperature of the projector should be between 0 °C (32 °F) and 45 °C (113 °F) when using it at elevations lower than 1 400 m (4 593') above sea level, and between 0 °C (32 °F) and 40 °C (104 °F) when using it at high altitudes (between 1 400 m (4 593') and 2 700 m (8 858') above sea level).
- Near high-voltage power lines or near motors: Doing so may interfere with the operation of the projector.
- Places where there is high-power laser equipment: Directing a laser beam onto the projection lens surface causes damage to the DLP chips.

### ■ Be sure to ask a specialized technician or your dealer when installing the projector on a ceiling.

The optional Ceiling Mount Bracket is required.

Model No.: ET-PKD120H (for high ceilings), ET-PKD120S (for low ceilings), ET-PKD130H (for High Ceilings, 6-axis Adjustment), ET-PKD130B (Projector Mount Bracket)

■ **Ask a qualified technician or your dealer to install the cable wiring for DIGITAL LINK connection.**

Image and sound may be disrupted if cable transmission characteristics cannot be obtained due to inadequate installation.

■ **The projector may not work properly due to strong radio wave from the broadcast station or the radio.**

If there is any facility or equipment, which outputs strong radio waves, near the installation location, install the projector at a location sufficiently far from the source of the radio waves. Or, wrap the LAN cable connected to the <DIGITAL LINK/LAN> terminal using a piece of metal foil or a metal pipe which is grounded at both ends.

■ **Focus adjustment**

The high clarity projection lens is thermally affected by the light from the light source, making the focus unstable in the period just after switching on the power. It is recommended that images be projected continuously for at least 30 minutes before the focus is adjusted.

■ **Do not install the projector at elevations of 2 700 m (8 858') or higher above sea level.**

Doing so may shorten the life of the components and result in malfunctions.

■ **Do not use the projector tilted to the right or left.**

Using the projector at a vertical angle that exceeds  $\pm 15^\circ$  may reduce product life or result in malfunction.

■ **Cautions when setting up the projector**

- Use the adjustable feet only for the floor standing installation and for adjusting the angle. Using them for other purposes may damage the projector.

- When installing the projector in a location other than on the floor using the adjustable feet or the ceiling mount, use the five screw holes for ceiling mount for fixing the projector (as shown in the figure).

(Screw diameter: M6, tapping depth inside the projector: 12 mm (15/32"), torque:  $4 \pm 0.5$  N·m)

Make sure that there is no clearance between the screw holes for ceiling mount on the projector bottom and the setting surface by inserting spacers (metallic) between them.

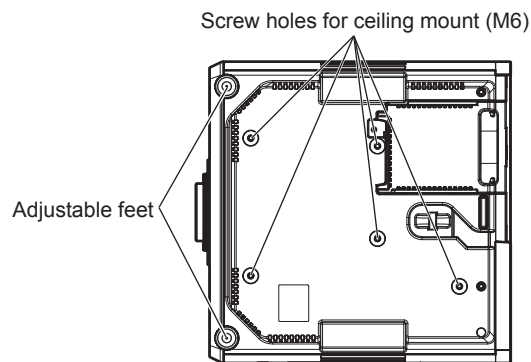

The positions of screw holes for ceiling mount and adjustable feet

- Do not stack projectors on top of each other.
- Do not use the projector supporting it by the top.
- Do not use the projector tilted at an angle that exceeds  $\pm 15^\circ$  from the horizontal plane.
- Do not block the ventilation ports (intake and exhaust) of the projector.

- Prevent hot and cool air from the air conditioning system to blow directly to the ventilation ports (intake and exhaust) of the projector.

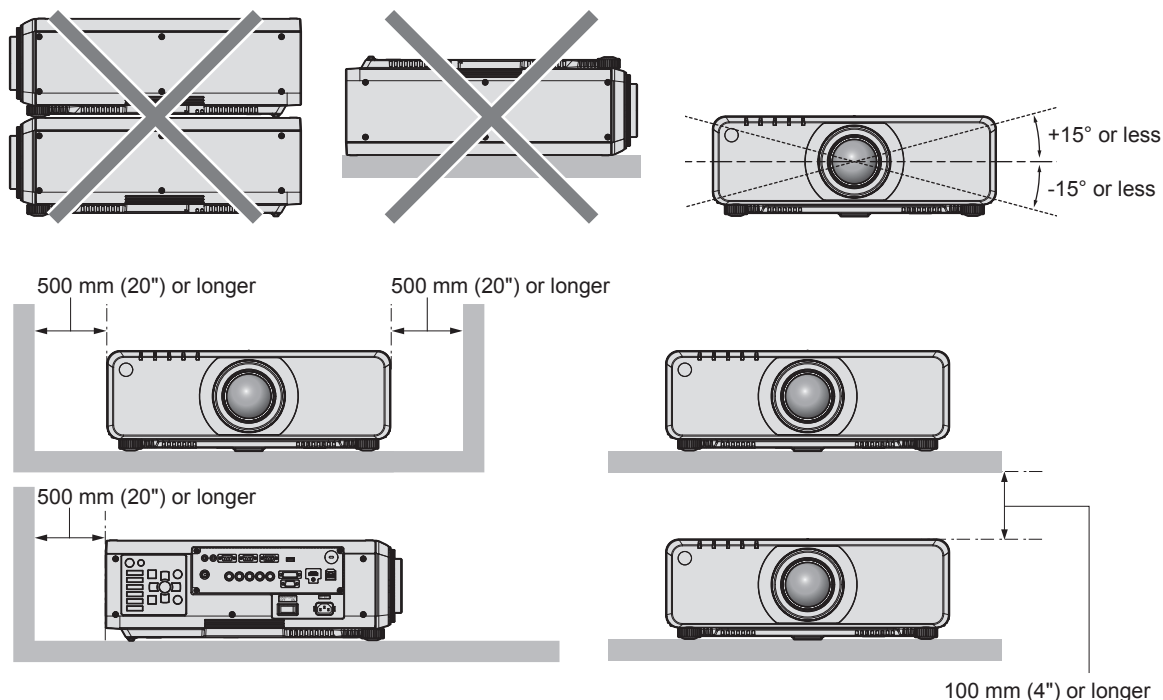

- Do not install the projector in a confined space.  
When installing the projector in a confined space, provide air conditioning or ventilation separately. Exhaust heat may accumulate when the ventilation is not enough, triggering the protection circuit of the projector.

## Security

When using this product, take safety measures against the following incidents.

- Personal information being leaked via this product
  - Unauthorized operation of this product by a malicious third party
  - Interfering or stopping of this product by a malicious third party
- Take sufficient security measures. (➔ pages 134, 157)
- Make your password difficult to guess as much as possible.
  - Change your password periodically.
  - Panasonic Corporation or its affiliate companies will never ask for your password directly. Do not divulge your password in case you receive such inquiries.
  - The connecting network must be secured by a firewall, etc.
  - Set a password for the web control and restrict the users who can log in.

## DIGITAL LINK

“DIGITAL LINK” is a technology to transmit the video, audio, Ethernet, and serial control signals using a twisted pair cable by adding unique functions by Panasonic to the HDBaseT™ communication standard formulated by HDBaseT Alliance.

This projector supports the optional Panasonic DIGITAL LINK output supported device (Model No.: ET-YFB100G, ET-YFB200G) and peripheral devices by other manufacturers (twisted-pair-cable transmitters such as the “XTP transmitter” of Extron Electronics) that use the same HDBaseT™ standard. For the devices of other manufacturers that the operation has been verified with this projector, refer to Panasonic website (<http://panasonic.net/avc/projector/>). Note that the verification for devices of other manufacturers has been made for the items set by Panasonic Corporation, and not all the operations have been verified. For operation or performance problems caused by the devices of other manufacturers, contact the respective manufacturers. In addition, the projector does not support audio transmission because it is not equipped with audio function.

## Art-Net

“Art-Net” is an Ethernet communication protocol based on the TCP/IP protocol.

By using the DMX controller or application software, illumination and stage system can be controlled. Art-Net is made based on DMX512 communication protocol.

## Early Warning Software

The projector supports “Early Warning Software”, which monitors the status of the display (projector and flat panel display) and the peripheral devices inside an intranet, and notifies of abnormality of such equipment and detects signs of possible abnormality. Also, maintenance can be performed in advance, because this software gives notification of approximate time to replace consumables of the display, to clean each part of the display, and to replace the components of the display.

Depending on the type of license, the number of displays that can be registered for monitoring varies. Limited to the first 90 days after installation in a computer, it is possible to register up to 2048 units of displays free of charge.

Download the software from Panasonic website (<http://panasonic.net/avc/projector/pass/>). It is necessary to register and login to PASS\*1 to download.

\*1 PASS: Panasonic Professional Display and Projector Technical Support Website  
Refer to Panasonic website (<http://panasonic.net/avc/projector/pass/>) for details.

## Disposal

To dispose of the product, ask your local authorities or dealer for correct methods of disposal.

The lamp contains mercury. When disposing of used lamp units, contact your local authorities or dealer for correct methods of disposal.

## Cautions on use

### ■ To get a good picture quality

In order to view a beautiful image in higher contrast, prepare an appropriate environment. Draw curtains or blinds over windows and turn off any lights near the screen to prevent outside light or light from indoor lamps from shining onto the screen.

### ■ Do not touch the surface of the projection lens with your bare hands.

If the surface of the projection lens becomes dirty from fingerprints or anything else, this will be magnified and projected onto the screen.

Attach the lens cover supplied with the projector or with the optional projection lens to the projector when you do not use the projector.

### ■ DLP chip

- The DLP chip is precision-made. Note that in rare cases, pixels of high precision could be missing or always lit. Note that such phenomena do not indicate malfunction.
- Directing a high-power laser beam onto the projection lens surface can damage the DLP chip.

### ■ Do not move the projector or subject it to vibration or impact while it is operating.

Doing so may shorten the life of the built-in motor.

### ■ Lamp

The light source of the projector is a high-pressure mercury lamp.

A high-pressure mercury lamp has the following characteristics.

- The luminance of the lamp will decrease by duration of usage.
- The lamp may burst with a loud sound or have its service life shortened because of shock, chipping, or degradation due to cumulative runtime.
- The lamp life varies greatly depending on individual differences and usage conditions. In particular, frequent on/off switching of the power greatly deteriorates the lamp and affects the lamp life.
- Continuous use for over one week will deteriorate the lamp. The degradation of the lamp due to continuous use can be reduced by using the [PROJECTOR SETUP] menu → [LAMP RELAY].
- In rare cases, the lamp bursts shortly after projection starts.
- The risk of bursting increases when the lamp is used beyond its replacement cycle. Make sure to replace the lamp unit regularly.

(“When to replace the lamp unit” (➡ page 166), “How to replace the lamp unit” (➡ page 167))

- If the lamp bursts, gas contained inside of the lamp is released in the form of smoke.
- It is recommended that you store the Replacement lamp unit as a contingency.

## ■ Computer and external device connections

- When connecting a computer or an external device, read this manual carefully regarding the use of power cords and shielded cables as well.

## Accessories

Make sure that the following accessories are provided with your projector. Numbers enclosed in < > show the number of accessories.

### Wireless/wired remote control unit <1> (N2QAYA000060)



### Lens Mount Cover <1> (Black model: TKPB64401) (White model: TKPB64402)



(The same color as the outer case will be supplied.)

### Lens cover <1> (TKKL5244-1)

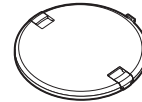

(Only models with lens)

### Power cord (TXFSX03VBDZ)

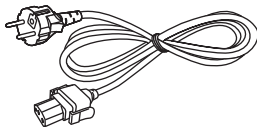

### (TXFSX02VBDZ)

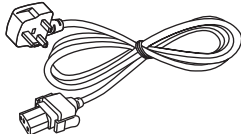

### (TXFSX03VARZ)

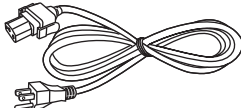

### (TXFSX02UTRZ)

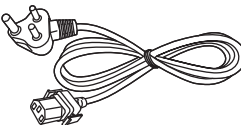

### CD-ROM <1> (TXFQB02WGDZ)



### AAA/R03 battery <2>

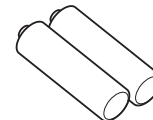

(For remote control unit)

## Attention

- After unpacking the projector, discard the power cord cap and packaging material properly.
- Do not use the supplied power cord for devices other than this projector.
- For missing accessories, consult your dealer.
- Store small parts in an appropriate manner, and keep them away from small children.

## Note

- The type and number of the supplied power cords vary depending on the country or region where you purchased the product.
- The model numbers of accessories are subject to change without prior notice.

## Contents of the supplied CD-ROM

The contents of the supplied CD-ROM are as follows.

Instruction/list (PDF)	Operating Instructions – Functional Manual	
	Multi Projector Monitoring & Control Software Operating Instructions	
	Logo Transfer Software Operating Instructions	
	List of Compatible Projector Models	This is a list of projectors that are compatible with the software contained in the CD-ROM and their restrictions.
Software	Multi Projector Monitoring & Control Software (Windows)	This software allows you to monitor and control multiple projectors connected to the LAN.
	Logo Transfer Software (Windows)	This software allows you to transfer original images, such as company logos to be displayed when projection starts, to the projector.

## Optional accessories

Optional accessories (product name)	Model No.	
Projection lens	Zoom lens	ET-DLE080, ET-DLE085, ET-DLE150, ET-DLE250, ET-DLE350, ET-DLE450
	Fixed-focus lens	ET-DLE030, ET-DLE055
Ceiling Mount Bracket	ET-PKD120H (for high ceilings), ET-PKD120S (for low ceilings), ET-PKD130H (for High Ceilings, 6-axis Adjustment), ET-PKD130B (Projector Mount Bracket)	
Replacement lamp unit	ET-LAD70 (1 pc), ET-LAD70W (2 pcs)	
Upgrade Kit	ET-UK20 (supported only for PT-DZ780)	
Auto Screen Adjustment Upgrade Kit	ET-CUK10 (supported only for PT-DZ780)	
Early Warning Software (Basic license/3-year license)	ET-SWA100 Series*1	
Digital Interface Box	ET-YFB100G	
DIGITAL LINK Switcher	ET-YFB200G	

\*1 The suffix of the Model No. differs according to the license type.

### Note

- The model numbers of optional accessories are subject to change without prior notice.

# About your projector

## Remote control

### ■ Front

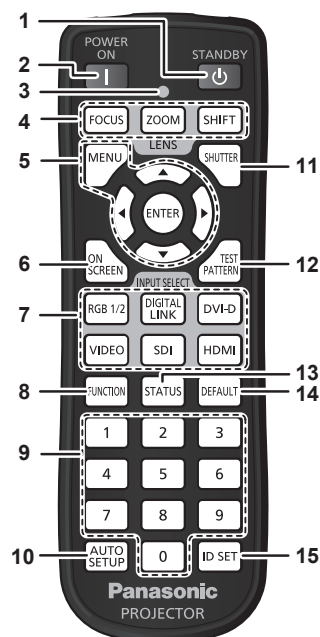

### ■ Top

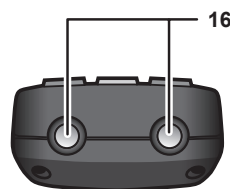

### ■ Bottom

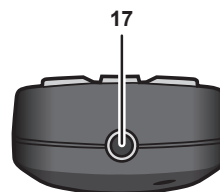

- 1 Power standby <⏻> button**  
Sets the projector to the state where the projector is switched off (standby mode) when the <MAIN POWER> switch on the projector is set to <ON> and in projection mode.
- 2 Power on <⏻> button**  
Starts projection when the <MAIN POWER> switch on the projector is set to <ON> when the power is switched off (standby mode).
- 3 Remote control indicator**  
Blinks if any button in the remote control is pressed.
- 4 Lens (<FOCUS>, <ZOOM>, <SHIFT>) buttons**  
Adjusts the projection lens. (➔ page 62)
- 5 <MENU> button/<ENTER> button/▲▼◀▶ buttons**  
Used to navigate through the menu screen. (➔ page 71)
- 6 <ON SCREEN> button**  
Switches the on-screen display function on (display) or off (hide). (➔ page 66)
- 7 Input selection (<RGB 1/2>, <DIGITAL LINK>, <DVI-D>, <VIDEO>, <SDI>, <HDMI>) buttons**  
Switches the input signal to project. (➔ page 67)  
(SDI input is supported only for PT-DZ780.)
- 8 <FUNCTION> button**  
Assigns a frequently used operation as a shortcut button. (➔ page 68)
- 9 Number (<0> - <9>) buttons**  
Used for entering an ID number or a password in a multiple projector environment.
- 10 <AUTO SETUP> button**  
Automatically adjusts the image display position while projecting the image.  
[PROGRESS] is displayed while in automatic adjustment. (➔ page 68)
- 11 <SHUTTER> button**  
Used to temporarily turn off the image. (➔ page 66)
- 12 <TEST PATTERN> button**  
Displays the test pattern. (➔ page 68)
- 13 <STATUS> button**  
Displays the projector information.
- 14 <DEFAULT> button**  
Resets the content of the sub-menu to the factory default. (➔ page 72)
- 15 <ID SET> button**  
Sets the ID number of the remote control in a multiple projector environment. (➔ page 28)
- 16 Remote control signal transmitter**
- 17 Remote control wired terminal**  
This is the terminal used to connect to the projector via a cable when used as a wired remote control. (➔ page 29)

### Attention

- Do not drop the remote control.
- Avoid contact with liquids or moisture.
- Do not attempt to modify or disassemble the remote control.

### Note

- When operating the remote control by directly pointing at the remote control signal receiver of the projector body, operate the remote control within a distance approx. 30 m (98'5") from the remote control signal receiver. The remote control can control at angles of up to  $\pm 30^\circ$  vertically and horizontally, but the effective control range may be reduced.
- If there are any obstacles between the remote control and the remote control signal receiver, the remote control may not operate properly.
- The signal will be reflected off the screen. However, the operating range may be limited from light reflection loss due to the screen material.
- If the remote control signal receiver directly receives strong light, such as fluorescent light, the remote control may not operate properly. Use it in a place distant from the light source.
- The power indicator <ON (G)/STANDBY (R)> will blink if the projector receives a remote control signal.



- The operation of the <VIDEO> button is disabled in the factory default settings. The operation is enabled when [REMOTE CONTROL] is set to [USER] and [VIDEO BUTTON] of [INPUT SELECT BUTTON] is set to other than [DISABLE], from the [SECURITY] menu → [CONTROL DEVICE SETUP] (➔ page 135).

## Projector body

### ■ Front

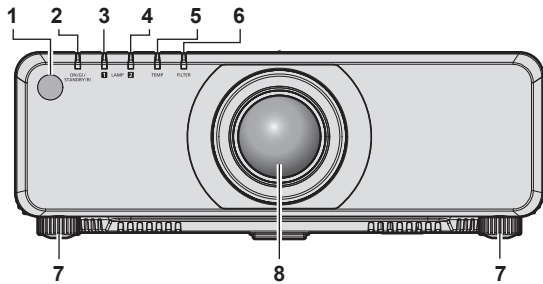

### ■ Side

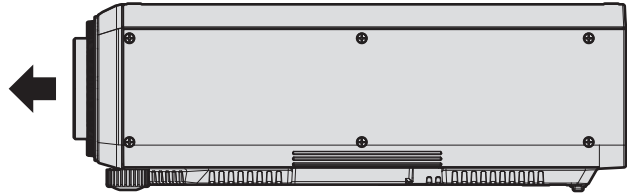

### ■ Rear

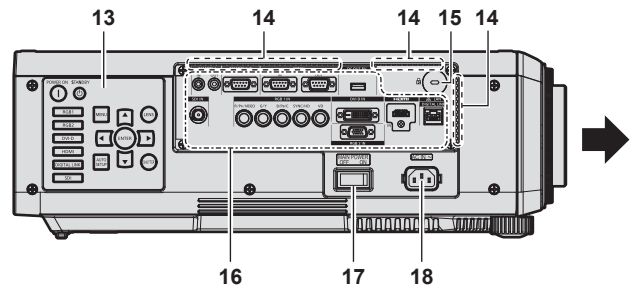
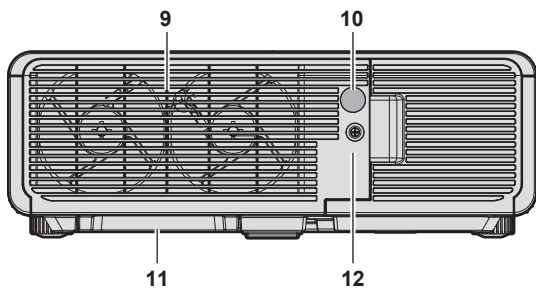

### ■ Bottom

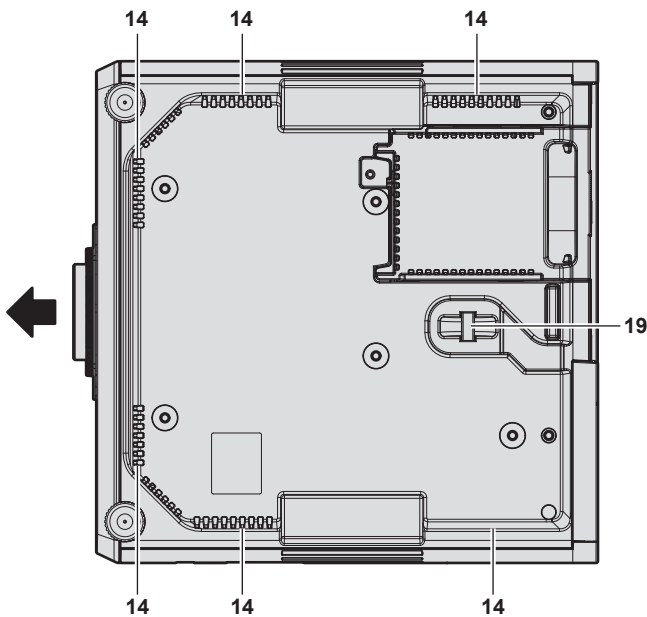

➔ : Projection direction

- 1 Remote control signal receiver (front)**
- 2 Power indicator <ON (G)/STANDBY (R)>**  
Displays the status of the power.
- 3 Lamp indicator <LAMP1>**  
Displays the status of lamp 1.
- 4 Lamp indicator <LAMP2>**  
Displays the status of lamp 2.
- 5 Temperature indicator <TEMP>**  
Displays the internal temperature status.
- 6 Filter indicator <FILTER>**  
Displays the status of the air filter case and air filter.
- 7 Adjustable feet**  
Adjusts the projection angle.
- 8 Projection lens**  
(Only models with lens)
- 9 Air exhaust port**
- 10 Remote control signal receiver (rear)**
- 11 Air filter case**
- 12 Lamp unit cover**
- 13 Control panel** (➔ page 26)
- 14 Air intake port**  
In addition to the bottom of the projector body, there are air intake ports around the connecting terminals too.
- 15 Security slot**  
This security slot is compatible with the Kensington security cables.
- 16 Connecting terminals** (➔ page 27)
- 17 <MAIN POWER> switch**  
Turns on/off the main power.
- 18 <AC IN> terminal**  
Connect the supplied power cord.
- 19 Burglar hook port**  
Attaches a burglar prevention cable, etc.

## Warning

Keep your hands and other objects away from the air exhaust port.

- Keep your hands and face away.
- Do not insert your fingers.
- Keep heat-sensitive objects away.

Heated air from the air exhaust port can cause burns, injury, or deformations.

**Attention**

- Do not block the ventilation ports (intake and exhaust) of the projector.

**■ Control panel**

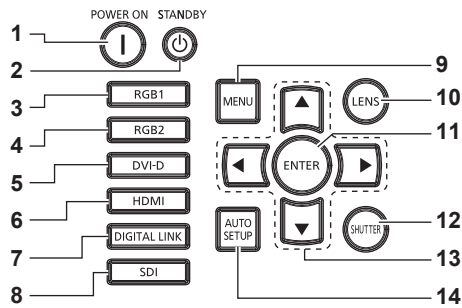

**1 Power on <|> button**

Starts projection when the <MAIN POWER> switch on the projector is set to <ON> when the power is switched off (standby mode).

**2 Power standby <⏻> button**

Sets the projector to the state where the projector is switched off (standby mode) when the <MAIN POWER> switch on the projector is set to <ON> and in projection mode.

**3 <RGB1> button**

Switches the input to RGB1.

**4 <RGB2> button**

Switches the input to RGB2.

**5 <DVI-D> button**

Switches the input to DVI-D.

**6 <HDMI> button**

Switches the input to HDMI.

**7 <DIGITAL LINK> button**

Switches the input to DIGITAL LINK.

**8 <SDI> button**

Switches the input to SDI.  
(Only for PT-DZ780)

**9 <MENU> button**

Displays or hides the main menu. (➔ page 71)  
Returns to the previous menu when a sub-menu is displayed.  
If you press the <MENU> button on the control panel for at least three seconds while the on-screen display is off (hidden), the on-screen display is turned on.

**10 <LENS> button**

Adjusts the focus, zoom, and shift (position) of the lens.

**11 <ENTER> button**

Determines and executes an item in the menu screen.

**12 <SHUTTER> button**

Used to temporarily turn off the image. (➔ page 66)

**13 ▲▼◀▶ buttons**

Used to select items in the menu screen, change settings, and adjust levels.  
Also used to enter a password in [SECURITY] or enter characters.

**14 <AUTO SETUP> button**

Automatically adjusts the image display position while projecting the image. [PROGRESS] is displayed while in automatic adjustment. (➔ page 68)

■ Connecting terminals

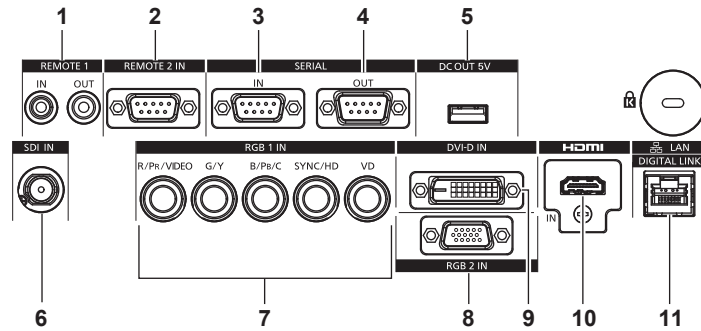

- |  |   |
|--|---|
| <p><b>1 &lt;REMOTE 1 IN&gt; terminal/&lt;REMOTE 1 OUT&gt; terminal</b><br/>These are the terminals to connect the remote control for serial control in a multiple projector environment.</p> <p><b>2 &lt;REMOTE 2 IN&gt; terminal</b><br/>This is a terminal to remotely control the projector using the external control circuit.</p> <p><b>3 &lt;SERIAL IN&gt; terminal</b><br/>This is the RS-232C compatible terminal to externally control the projector by connecting a computer.</p> <p><b>4 &lt;SERIAL OUT&gt; terminal</b><br/>This is a terminal to output the signal connected to the &lt;SERIAL IN&gt; terminal.</p> <p><b>5 &lt;DC OUT 5V&gt; terminal</b><br/>This is a USB terminal only for power supply. (DC 5 V, maximum 900 mA)<br/>This can be used when power is to be supplied to a wireless display adapter, etc.</p> | <p><b>6 &lt;SDI IN&gt; terminal</b><br/>This is the terminal to input SDI signals.<br/>(Only for PT-DZ780)</p> <p><b>7 &lt;RGB 1 IN&gt; (&lt;R/P<sub>R</sub>/VIDEO&gt;, &lt;G/Y&gt;, &lt;B/P<sub>B</sub>/C&gt;, &lt;SYNC/HD&gt;, &lt;VD&gt;) terminals</b><br/>These are terminals to input RGB signals, YC<sub>B</sub>C<sub>R</sub>/YP<sub>B</sub>P<sub>R</sub> signals, Y/C signals, or video signals.</p> <p><b>8 &lt;RGB 2 IN&gt; terminal</b><br/>This is a terminal to input RGB signals or YC<sub>B</sub>C<sub>R</sub>/YP<sub>B</sub>P<sub>R</sub> signals.</p> <p><b>9 &lt;DVI-D IN&gt; terminal</b><br/>This is the terminal to input DVI-D signals.</p> <p><b>10 &lt;HDMI IN&gt; terminal</b><br/>This is the terminal to input HDMI signals.</p> <p><b>11 &lt;DIGITAL LINK/LAN&gt; terminal</b><br/>This is the LAN terminal to connect to the network. This is also used when connecting a video signal transmission device via the LAN terminal.</p> |
|--|---|

**Attention**

- When a LAN cable is directly connected to the projector, the network connection must be made indoors.

# Preparing the remote control

## Inserting and removing the batteries

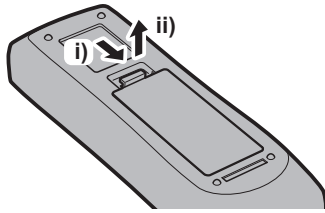

Fig. 1

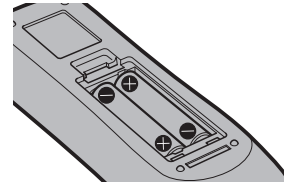

Fig. 2

- 1) **Open the cover. (Fig. 1)**
- 2) **Insert the batteries and close the cover (insert the  $\ominus$  side first). (Fig. 2)**
  - When removing the batteries, perform the steps in reverse order.

## When using the multiple projectors

When you use the multiple projectors together, you can control all the projectors simultaneously or each projector individually using single remote control, if a unique ID number is assigned to each projector.

When using the projectors by setting the ID numbers, set the ID number of the projector body after initial settings have been completed. Then, set the ID number of the remote control. For initial settings, refer to “When the initial setting screen is displayed” (➔ page 57).

The factory default ID number of the projector (projector body and remote control) is set to [ALL], so you can use it as it is. Set the ID numbers of the projector body and remote control as necessary.

For details on setting the ID number of the remote control, refer to “Setting the remote control ID numbers” (➔ page 69).

### Note

- Set the ID number of the projector body from the [PROJECTOR SETUP] menu → [PROJECTOR ID].

## Connecting the remote control to the projector with a cable

When you use the system with multiple projectors, use commercially available M3 stereo mini jack cables and connect the other devices to the <REMOTE 1 IN>/<REMOTE 1 OUT> terminals of the projector. The remote control is effective even in places where an obstacle stands in the light path or where devices are susceptible to outside light.

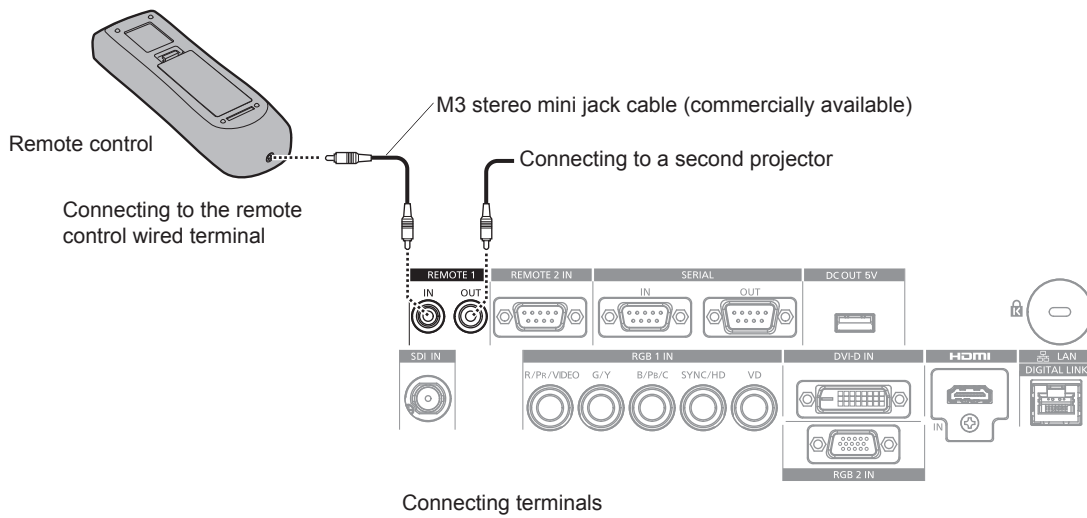

### Attention

- Use a cable that is 15 m (49'3") or shorter, with 2 core shielded. The remote control may not operate when the length of the cable exceeds 15 m (49'3") or when the shielding of the cable is inadequate.

# Chapter 2 **Getting Started**

---

This chapter describes things you need to do before using the projector such as the setup and connections.

# Setting up

## Installation mode

There are four ways to set up the projector. Set the [PROJECTOR SETUP] menu → [PROJECTION METHOD] (➔ page 111) depending on the installation mode. Set [COOLING CONDITION] to [AUTO]. Using the projector with [COOLING CONDITION] set incorrectly may shorten the life of the lamp.

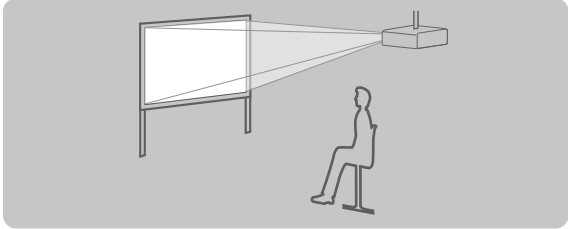
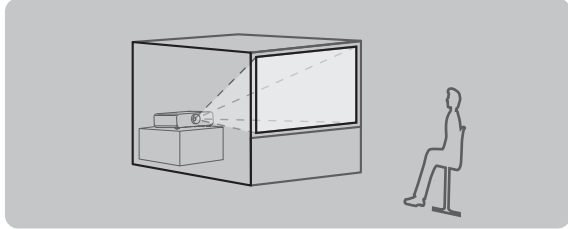
<b>Mounting on the ceiling and projecting forward</b> 		<b>Setting on a desk/floor and projecting from rear</b> (Using the translucent screen) 	
<b>Menu item</b>	<b>Method</b>	<b>Menu item</b>	<b>Method</b>
[PROJECTOR METHOD]	[FRONT/CEILING]	[PROJECTOR METHOD]	[REAR/FLOOR]
[COOLING CONDITION]	[AUTO]	[COOLING CONDITION]	[AUTO]

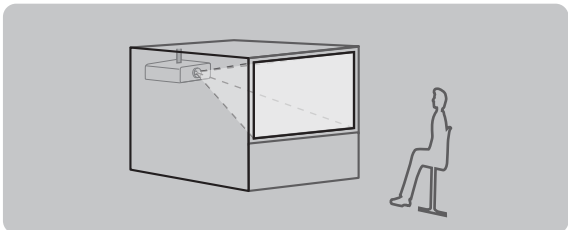
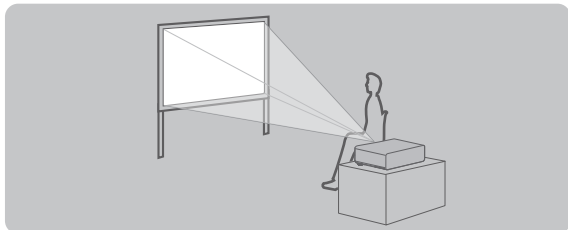
<b>Mounting on the ceiling and projecting from rear</b> (Using the translucent screen) 		<b>Setting on a desk/floor and projecting forward</b> 	
<b>Menu item</b>	<b>Method</b>	<b>Menu item</b>	<b>Method</b>
[PROJECTOR METHOD]	[REAR/CEILING]	[PROJECTOR METHOD]	[FRONT/FLOOR]
[COOLING CONDITION]	[AUTO]	[COOLING CONDITION]	[AUTO]

## Parts for ceiling mount (optional)

The projector can be installed on the ceiling by combining the optional Ceiling Mount Bracket (Model No.: ET-PKD120H (for high ceilings), ET-PKD120S (for low ceilings), ET-PKD130H (for High Ceilings, 6-axis Adjustment)) and the Ceiling Mount Bracket (Model No.: ET-PKD130B (Projector Mount Bracket)).

- Be sure to use the ceiling mount bracket specified for this projector.
- Refer to the Installation Instructions of the ceiling mount bracket when installing and setting up the projector.

### Attention

- To ensure projector performance and security, installation of the Ceiling Mount Bracket must be carried out by your dealer or a qualified technician.

## Projected image and throw distance

Refer to the projected image size and projection distance to install the projector. Image size and image position can be adjusted in accordance with the screen size and screen position. When the fixed-focus lens (Model No.: ET-DLE030) is attached, the projection relation between the screen and the projector differs from that of other lenses. Refer to “For fixed-focus lens (Model No.: ET-DLE030)” (➡ page 33) for details.

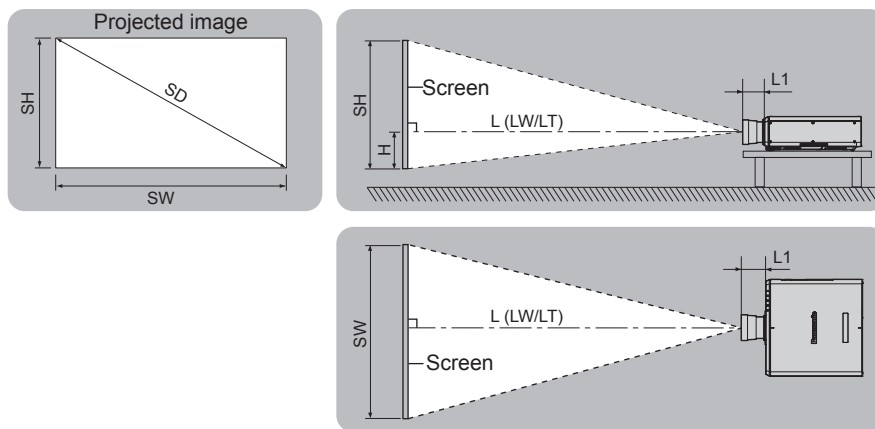

(Unit: m)

L (LW/LT)*1	Projection distance
L1	Lens protrusion dimension
SH	Projected image height
SW	Projected image width
H	Distance from the lens center to the bottom edge of the projected image
SD	Projected image size

\*1 LW: Minimum projection distance when the Zoom Lens is used  
 LT: Maximum projection distance when the Zoom Lens is used

(Unit: m)

Projection lens Model No.	Dimension for L1 (approximate value)
Standard zoom lens	0.023
ET-DLE055	0.007
ET-DLE080/ ET-DLE085	0.064
ET-DLE150	0.024
ET-DLE250	0.025
ET-DLE350	0.031
ET-DLE450	0.075



■ For fixed-focus lens (Model No.: ET-DLE030)

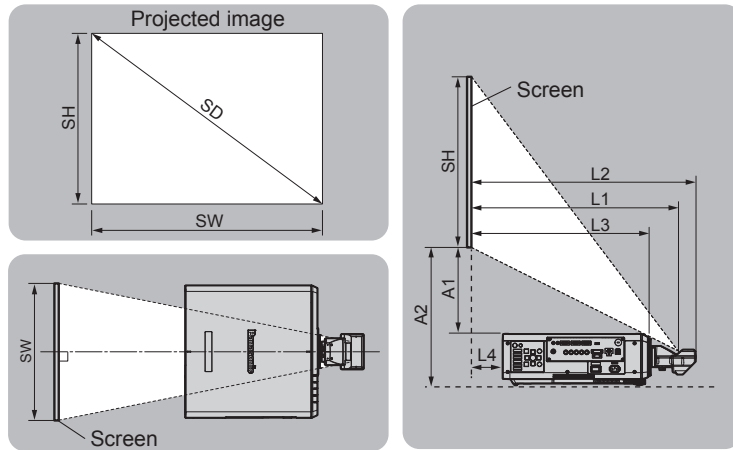

(Unit: m)

SH	Projected image height
SW	Projected image width
SD	Projected image size
L1	Projection distance (from the screen to the mirror reflection surface <sup>*1</sup> )
L2	Distance between the projector and the screen (from the screen to the tip of the lens)
L3	Distance between the projector and the screen (from the screen to the front surface of the projector)
L4	Distance between the projector and the screen (from the screen to the rear surface of the projector)
A1	Distance between the projector and the screen (from the screen bottom edge to the projector top)
A2	Distance between the projector and the screen (from the screen bottom edge to the projector bottom)

\*1 The mirror reflection surface cannot be seen from the outside because it is located inside the fixed-focus lens.

(Unit: m)

Distance between projector and screen	Formula
L2	$= L1^{*1} + 0.023$
L3	$= L1^{*1} - 0.146$
L4	$= L1^{*1} - 0.644$
A2	$= A1^{*1} + 0.175$

\*1 For details of calculating values, refer to "Formula to calculate projection distance per projection lens" (➡ page 44).

**Attention**

- Before setting up, read "Precautions for use" (➡ page 18).  
Especially when the fixed-focus lens (Model No.: ET-DLE030) is used, install the projector so its back plane is parallel to the screen so the projected image is rectangular.  
The vertical keystone distortion in moderate range can be corrected by the [POSITION] menu → [GEOMETRY] → [KEystone] → [VERTICAL KEystone] (➡ page 86) even after it is installed. For the range that can be corrected, refer to "[GEOMETRY] projection range" (➡ page 34).
- Do not use the projector and the high-powered laser equipment in the same room. The DLP chips can be damaged if a laser beam hits the projection lens surface.

[GEOMETRY] projection range

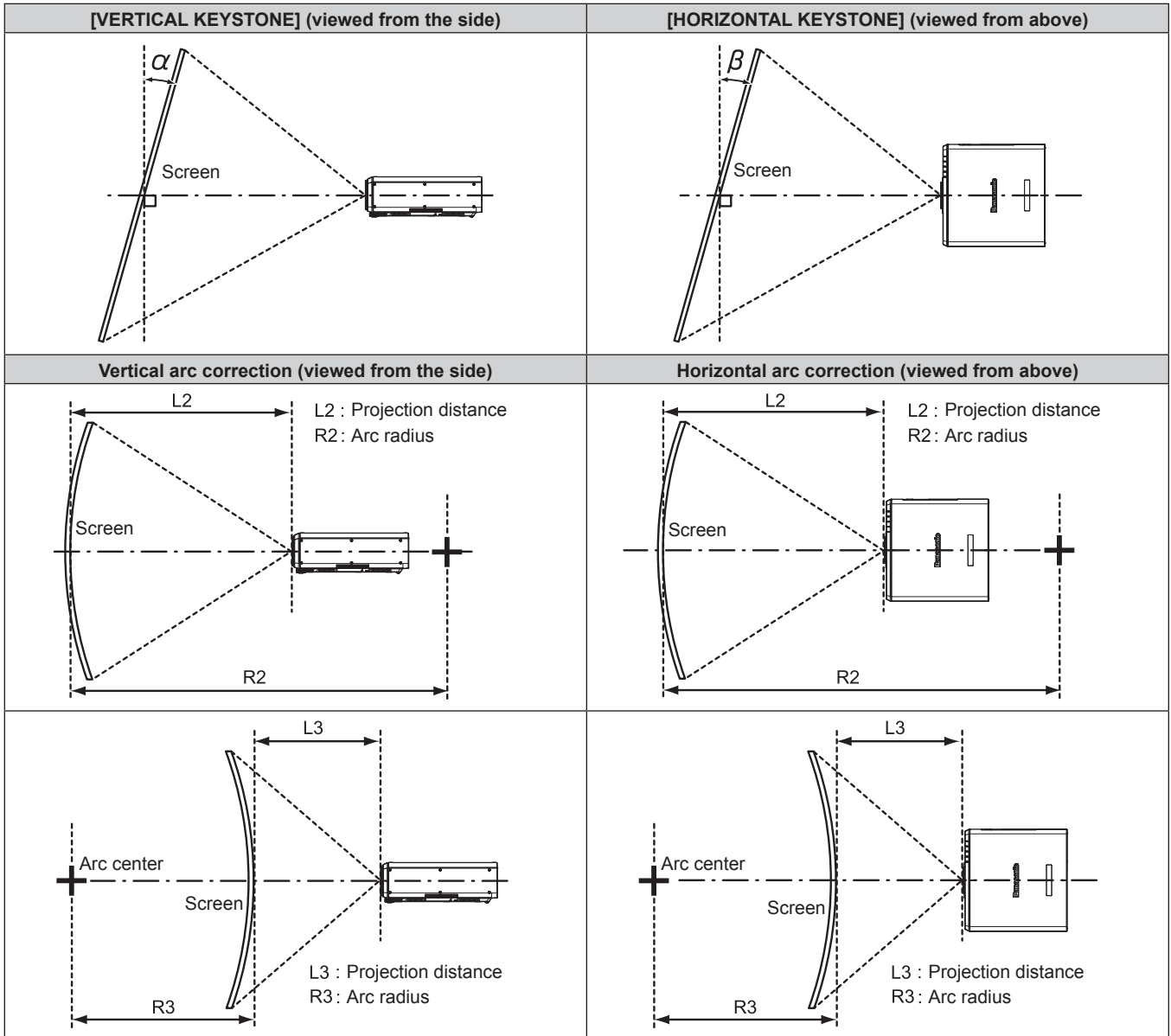

**Standard status**

Projection lens Model No.	Only [KEYSTONE] used		[KEYSTONE] and [CURVED] used together				Only [CURVED] used	
	Vertical keystone correction angle $\alpha$ (°)	Horizontal keystone correction angle $\beta$ (°)	Vertical keystone correction angle $\alpha$ (°)	Horizontal keystone correction angle $\beta$ (°)	Minimum value of R2/L2	Minimum value of R3/L3	Minimum value of R2/L2	Minimum value of R3/L3
Standard zoom lens	±40	±15	±20	±15	0.9	1.7	0.5	1
ET-DLE030*1	+5 / -0	0	—	—	—	—	—	—
ET-DLE055	±22	±15	±8	±8	1.7	4.3	1	2.6
ET-DLE080/ ET-DLE085	±22	±15	±8	±8	1.7	4.3	1	2.6
ET-DLE150	±40	±15	±20	±15	1.1	2.6	0.6	1.5
ET-DLE250	±40	±15	±20	±15	0.7	1.3	0.4	0.7
ET-DLE350	±40	±15	±20	±15	0.4	0.8	0.3	0.5
ET-DLE450	±40	±15	±20	±15	0.3	0.6	0.2	0.3

\*1 Only the vertical keystone correction angle can be corrected in the direction in which the projector body moves away from the screen.

**When using the optional Upgrade Kit (Model No.: ET-UK20)**

(Only for PT-DZ780)

Projection lens Model No.	Only [KEYSTONE] used*1		[KEYSTONE] and [CURVED] used together				Only [CURVED] used	
	Vertical keystone correction angle $\alpha$ (°)	Horizontal keystone correction angle $\beta$ (°)	Vertical keystone correction angle $\alpha$ (°)	Horizontal keystone correction angle $\beta$ (°)	Minimum value of R2/L2	Minimum value of R3/L3	Minimum value of R2/L2	Minimum value of R3/L3
Standard zoom lens	±40	±40	±20	±15	0.7	1.3	0.4	0.7
ET-DLE030*2	+5 / -0	0	—	—	—	—	—	—
ET-DLE055	±22	±15	±8	±8	1.3	3.3	0.8	1.9
ET-DLE080/ ET-DLE085	±22	±15	±8	±8	1.3	3.3	0.8	1.9
ET-DLE150	±40	±40	±20	±15	0.9	2	0.5	1.1
ET-DLE250	±40	±40	±20	±15	0.5	1	0.3	0.6
ET-DLE350	±45	±40	±20	±15	0.3	0.6	0.2	0.4
ET-DLE450	±45	±40	±20	±15	0.2	0.4	0.2	0.3

\*1 [VERTICAL KEYSTONE] and [HORIZONTAL KEYSTONE] cannot be corrected if the total exceeds 55° when used at the same time.

\*2 Only the vertical keystone correction angle can be corrected in the direction in which the projector body moves away from the screen.

**Note**

- When [GEOMETRY] is used, the focus of the entire screen may be lost as correction increases.
- Make the curved screen a circular arc shape with one part of a perfect circle removed.
- Adjustment range of the [GEOMETRY] items may not match the listed projection range depending on the projection lens. Use this projector within the projection range, otherwise the correction may not work.

**Projection distance of each projection lens**

A ±5 % error in listed projection distances may occur.

When [GEOMETRY] is used, distance is corrected to become smaller than the specified image size.

**For PT-DZ780**

**■ When the image aspect ratio is 16:10**

(Unit: m)

Lens type			Standard zoom lens		Optional lens								
					Fixed-focus lens			Ultra short focus zoom lens		Short focus zoom lens			
Projection lens Model No.			—		ET-DLE030 <sup>*2</sup>		ET-DLE055	ET-DLE080/ ET-DLE085		ET-DLE150			
Throw ratio <sup>*1</sup>			1.7-2.4:1		0.38:1			0.8:1	0.8-1.0:1		1.3-1.9:1		
Projected image size			Projection distance (L)		Projection distance (L1)	Distance between projector and screen		Projection distance (L)					
						(L4)	(A1)	Fixed	Min. (LW)	Max. (LT)	Min. (LW)	Max. (LT)	
Diagonal (SD)	Height (SH)	Width (SW)	Min. (LW)	Max. (LT)									
1.27 (50")	0.673	1.077	1.82	2.57	—	—	—	0.83	0.82	1.04	1.38	2.01	
1.52 (60")	0.808	1.292	2.20	3.10	—	—	—	1.00	1.00	1.25	1.66	2.43	
1.78 (70")	0.942	1.508	2.58	3.63	—	—	—	1.18	1.17	1.47	1.95	2.84	
2.03 (80")	1.077	1.723	2.95	4.16	—	—	—	1.35	1.35	1.68	2.23	3.25	
2.29 (90")	1.212	1.939	3.33	4.69	—	—	—	1.53	1.52	1.90	2.52	3.66	
2.54 (100")	1.346	2.154	3.71	5.21	0.82	0.17	0.43	1.70	1.70	2.11	2.81	4.08	
3.05 (120")	1.615	2.585	4.47	6.27	0.98	0.34	0.54	2.05	2.05	2.55	3.38	4.90	
3.81 (150")	2.019	3.231	5.60	7.86	1.23	0.58	0.69	2.58	2.57	3.19	4.24	6.14	
5.08 (200")	2.692	4.308	7.50	10.50	1.63	0.99	0.94	3.45	3.44	4.27	5.67	8.20	
6.35 (250")	3.365	5.385	9.39	13.14	2.04	1.40	1.19	—	4.31	5.35	7.10	10.26	
7.62 (300")	4.039	6.462	11.28	15.79	2.45	1.80	1.44	—	5.18	6.43	8.53	12.33	
8.89 (350")	4.712	7.539	13.18	18.43	2.85	2.21	1.69	—	6.06	7.51	9.96	14.39	
10.16 (400")	5.385	8.616	15.07	21.07	—	—	—	—	6.93	8.59	11.39	16.45	
12.70 (500")	6.731	10.770	18.86	26.36	—	—	—	—	8.67	10.75	14.25	20.58	
15.24 (600")	8.077	12.923	22.64	31.65	—	—	—	—	10.42	12.91	17.11	24.70	

Lens type			Optional lens						Height position (H) <sup>*3</sup>	
			Intermediate focus zoom lens		Long focus zoom lens		Ultra long focus zoom lens			
Projection lens Model No.			ET-DLE250		ET-DLE350		ET-DLE450		Standard zoom lens/ET-DLE080/ ET-DLE150/ ET-DLE250/ ET-DLE350/ ET-DLE450	
Throw ratio <sup>*1</sup>			2.3-3.6:1		3.6-5.4:1		5.4-8.6:1		ET-DLE055 (Fixed)	
Projected image size			Projection distance (L)							
			Min. (LW)	Max. (LT)	Min. (LW)	Max. (LT)	Min. (LW)	Max. (LT)		
Diagonal (SD)	Height (SH)	Width (SW)	Min. (LW)	Max. (LT)	Min. (LW)	Max. (LT)	Min. (LW)	Max. (LT)		
1.27 (50")	0.673	1.077	2.42	3.87	3.80	5.81	5.66	9.12	0 - 0.44	0.34
1.52 (60")	0.808	1.292	2.92	4.65	4.59	7.00	6.85	11.01	0 - 0.53	0.40
1.78 (70")	0.942	1.508	3.42	5.44	5.38	8.19	8.04	12.89	0 - 0.62	0.47
2.03 (80")	1.077	1.723	3.92	6.23	6.16	9.38	9.23	14.78	0 - 0.71	0.54
2.29 (90")	1.212	1.939	4.42	7.02	6.95	10.57	10.43	16.66	0 - 0.80	0.61
2.54 (100")	1.346	2.154	4.92	7.81	7.74	11.76	11.62	18.55	0 - 0.89	0.67
3.05 (120")	1.615	2.585	5.91	9.39	9.31	14.14	14.00	22.31	0 - 1.07	0.81
3.81 (150")	2.019	3.231	7.41	11.75	11.68	17.71	17.58	27.97	0 - 1.33	1.01
5.08 (200")	2.692	4.308	9.91	15.70	15.61	23.66	23.54	37.39	0 - 1.78	1.35
6.35 (250")	3.365	5.385	12.41	19.64	19.55	29.61	29.50	46.81	0 - 2.22	—
7.62 (300")	4.039	6.462	14.91	23.59	23.49	35.56	35.46	56.24	0 - 2.67	—
8.89 (350")	4.712	7.539	17.40	27.53	27.42	41.51	41.42	65.66	0 - 3.11	—
10.16 (400")	5.385	8.616	19.90	31.48	31.36	47.46	47.38	75.08	0 - 3.55	—
12.70 (500")	6.731	10.770	24.90	39.37	39.23	59.36	59.30	93.93	0 - 4.44	—
15.24 (600")	8.077	12.923	29.89	47.25	47.11	71.25	71.22	112.77	0 - 5.33	—

\*1 The throw ratio is based on the value during projection of 2.03 m (80") projected image size. When the fixed-focus lens (Model No.: ET-DLE030) is attached, it is based on the value during projection of 2.54 m (100") projected image size.

\*2 When the fixed-focus lens (Model No.: ET-DLE030) is attached, the projection relation between the screen and the projector differs from that of other lenses. Refer to "For fixed-focus lens (Model No.: ET-DLE030)" (▶ page 33) for details.

\*3 When the fixed-focus lens (Model No.: ET-DLE055) is attached, the lens shift is not possible, therefore the height position (H) becomes SH/2.

■ When the image aspect ratio is 16:9

(Unit: m)

Lens type			Standard zoom lens		Optional lens							
					Fixed-focus lens			Ultra short focus zoom lens		Short focus zoom lens		
Projection lens Model No.			—		ET-DLE030*2			ET-DLE055	ET-DLE080/ ET-DLE085		ET-DLE150	
Throw ratio*1			1.7-2.4:1		0.38:1			0.8:1	0.8-1.0:1		1.3-1.9:1	
Projected image size			Projection distance (L)		Projection distance (L1)	Distance between projector and screen		Projection distance (L)				
						(L4)	(A1)	Fixed	Min. (LW)	Max. (LT)	Min. (LW)	Max. (LT)
1.27 (50")	0.623	1.107	1.87	2.64	—	—	—	0.85	0.85	1.07	1.42	2.07
1.52 (60")	0.747	1.328	2.26	3.19	—	—	—	1.03	1.03	1.29	1.71	2.49
1.78 (70")	0.872	1.550	2.65	3.73	—	—	—	1.21	1.21	1.51	2.00	2.92
2.03 (80")	0.996	1.771	3.04	4.27	—	—	—	1.39	1.39	1.73	2.30	3.34
2.29 (90")	1.121	1.992	3.43	4.82	—	—	—	1.57	1.57	1.95	2.59	3.77
2.54 (100")	1.245	2.214	3.82	5.36	0.84	0.20	0.52	1.75	1.75	2.17	2.89	4.19
3.05 (120")	1.494	2.657	4.60	6.45	1.01	0.36	0.64	2.11	2.10	2.62	3.47	5.04
3.81 (150")	1.868	3.321	5.76	8.08	1.26	0.62	0.81	2.65	2.64	3.28	4.36	6.31
5.08 (200")	2.491	4.428	7.71	10.80	1.68	1.03	1.10	3.55	3.54	4.39	5.82	8.43
6.35 (250")	3.113	5.535	9.65	13.51	2.10	1.45	1.40	—	4.43	5.50	7.29	10.55
7.62 (300")	3.736	6.641	11.60	16.23	2.51	1.87	1.69	—	5.33	6.61	8.76	12.67
8.89 (350")	4.358	7.748	13.55	18.95	2.93	2.29	1.98	—	6.23	7.72	10.23	14.79
10.16 (400")	4.981	8.855	15.49	21.66	—	—	—	—	7.12	8.83	11.70	16.91
12.70 (500")	6.226	11.069	19.38	27.10	—	—	—	—	8.91	11.05	14.64	21.15
15.24 (600")	7.472	13.283	23.27	32.53	—	—	—	—	10.71	13.27	17.58	25.39

Lens type			Optional lens						Height position (H)*3	
			Intermediate focus zoom lens		Long focus zoom lens		Ultra long focus zoom lens			
Projection lens Model No.			ET-DLE250		ET-DLE350		ET-DLE450		Standard zoom lens/ET-DLE080/ ET-DLE085/ ET-DLE150/ ET-DLE250/ ET-DLE350/ ET-DLE450	
Throw ratio*1			2.3-3.6:1		3.6-5.4:1		5.4-8.6:1			
Projected image size			Projection distance (L)						ET-DLE055 (Fixed)	
			Min. (LW)	Max. (LT)	Min. (LW)	Max. (LT)	Min. (LW)	Max. (LT)		
1.27 (50")	0.623	1.107	2.49	3.97	3.91	5.98	5.82	9.39	-0.06 - 0.46	0.31
1.52 (60")	0.747	1.328	3.00	4.79	4.72	7.20	7.05	11.32	-0.07 - 0.55	0.37
1.78 (70")	0.872	1.550	3.51	5.60	5.53	8.43	8.27	13.26	-0.09 - 0.64	0.44
2.03 (80")	0.996	1.771	4.03	6.41	6.34	9.65	9.50	15.20	-0.10 - 0.73	0.50
2.29 (90")	1.121	1.992	4.54	7.22	7.15	10.87	10.72	17.13	-0.11 - 0.82	0.56
2.54 (100")	1.245	2.214	5.05	8.03	7.96	12.09	11.95	19.07	-0.12 - 0.91	0.62
3.05 (120")	1.494	2.657	6.08	9.65	9.58	14.54	14.40	22.94	-0.15 - 1.10	0.75
3.81 (150")	1.868	3.321	7.62	12.08	12.00	18.21	18.08	28.75	-0.19 - 1.37	0.93
5.08 (200")	2.491	4.428	10.19	16.14	16.05	24.32	24.20	38.44	-0.25 - 1.83	1.25
6.35 (250")	3.113	5.535	12.75	20.19	20.10	30.44	30.33	48.12	-0.31 - 2.28	—
7.62 (300")	3.736	6.641	15.32	24.25	24.14	36.55	36.45	57.81	-0.37 - 2.74	—
8.89 (350")	4.358	7.748	17.89	28.30	28.19	42.67	42.58	67.49	-0.44 - 3.20	—
10.16 (400")	4.981	8.855	20.46	32.35	32.24	48.78	48.71	77.18	-0.50 - 3.65	—
12.70 (500")	6.226	11.069	25.59	40.46	40.33	61.01	60.96	96.55	-0.62 - 4.57	—
15.24 (600")	7.472	13.283	30.72	48.57	48.42	73.24	73.21	115.91	-0.75 - 5.48	—

\*1 The throw ratio is based on the value during projection of 2.03 m (80") projected image size. When the fixed-focus lens (Model No.: ET-DLE030) is attached, it is based on the value during projection of 2.54 m (100") projected image size.

\*2 When the fixed-focus lens (Model No.: ET-DLE030) is attached, the projection relation between the screen and the projector differs from that of other lenses. Refer to "For fixed-focus lens (Model No.: ET-DLE030)" (➡ page 33) for details.

\*3 When the fixed-focus lens (Model No.: ET-DLE055) is attached, the lens shift is not possible, therefore the height position (H) becomes SH/2.

■ When the image aspect ratio is 4:3

(Unit: m)

Lens type			Standard zoom lens		Optional lens							
					Fixed-focus lens			Ultra short focus zoom lens		Short focus zoom lens		
Projection lens Model No.			—		ET-DLE030*2			ET-DLE055	ET-DLE080/ ET-DLE085		ET-DLE150	
Throw ratio*1			2.1-2.9:1		0.46:1			0.9:1	0.9-1.2:1		1.6-2.3:1	
Projected image size			Projection distance (L)		Projection distance (L1)	Distance between projector and screen		Projection distance (L)				
						(L4)	(A1)	Fixed	Min. (LW)	Max. (LT)	Min. (LW)	Max. (LT)
1.27 (50")	0.762	1.016	2.07	2.92	—	—	—	0.94	0.94	1.18	1.56	2.29
1.52 (60")	0.914	1.219	2.50	3.52	—	—	—	1.14	1.14	1.42	1.89	2.75
1.78 (70")	1.067	1.422	2.93	4.12	—	—	—	1.34	1.33	1.67	2.21	3.22
2.03 (80")	1.219	1.626	3.35	4.72	—	—	—	1.54	1.53	1.91	2.54	3.69
2.29 (90")	1.372	1.829	3.78	5.31	—	—	—	1.74	1.73	2.16	2.86	4.15
2.54 (100")	1.524	2.032	4.21	5.91	0.93	0.28	0.50	1.93	1.93	2.40	3.18	4.62
3.05 (120")	1.829	2.438	5.07	7.11	1.11	0.47	0.61	2.33	2.32	2.89	3.83	5.55
3.81 (150")	2.286	3.048	6.35	8.91	1.39	0.74	0.79	2.93	2.91	3.62	4.80	6.96
5.08 (200")	3.048	4.064	8.50	11.90	1.85	1.20	1.07	3.92	3.90	4.84	6.42	9.29
6.35 (250")	3.810	5.080	10.64	14.89	2.31	1.66	1.35	—	4.89	6.07	8.04	11.63
7.62 (300")	4.572	6.096	12.78	17.88	2.77	2.13	1.64	—	5.88	7.29	9.66	13.96
8.89 (350")	5.334	7.112	14.93	20.88	3.23	2.59	1.92	—	6.86	8.51	11.28	16.30
10.16 (400")	6.096	8.128	17.07	23.87	—	—	—	—	7.85	9.73	12.90	18.63
12.70 (500")	7.620	10.160	21.36	29.85	—	—	—	—	9.82	12.17	16.13	23.30
15.24 (600")	9.144	12.192	25.64	35.84	—	—	—	—	11.80	14.62	19.37	27.97

Lens type			Optional lens						Height position (H)*3		
			Intermediate focus zoom lens		Long focus zoom lens		Ultra long focus zoom lens				
Projection lens Model No.			ET-DLE250		ET-DLE350		ET-DLE450		Standard zoom lens/ET-DLE080/ ET-DLE085/ ET-DLE150/ ET-DLE250/ ET-DLE350/ ET-DLE450		ET-DLE055 (Fixed)
Throw ratio*1			2.7-4.3:1		4.3-6.5:1		6.5-10.3:1				
Projected image size			Projection distance (L)								
			Diagonal (SD)	Height (SH)	Width (SW)	Min. (LW)	Max. (LT)	Min. (LW)	Max. (LT)	Min. (LW)	Max. (LT)
1.27 (50")	0.762	1.016	2.75	4.39	4.32	6.60	6.45	10.37	0 - 0.50	0.38	
1.52 (60")	0.914	1.219	3.31	5.28	5.21	7.95	7.80	12.50	0 - 0.60	0.46	
1.78 (70")	1.067	1.422	3.88	6.17	6.10	9.29	9.14	14.63	0 - 0.70	0.53	
2.03 (80")	1.219	1.626	4.44	7.07	7.00	10.64	10.49	16.77	0 - 0.80	0.61	
2.29 (90")	1.372	1.829	5.01	7.96	7.89	11.99	11.84	18.90	0 - 0.91	0.69	
2.54 (100")	1.524	2.032	5.57	8.85	8.78	13.34	13.19	21.03	0 - 1.01	0.76	
3.05 (120")	1.829	2.438	6.71	10.64	10.56	16.03	15.89	25.30	0 - 1.21	0.91	
3.81 (150")	2.286	3.048	8.40	13.32	13.24	20.07	19.94	31.70	0 - 1.51	1.14	
5.08 (200")	3.048	4.064	11.23	17.78	17.69	26.80	26.69	42.37	0 - 2.01	1.52	
6.35 (250")	3.810	5.080	14.06	22.25	22.15	33.54	33.44	53.04	0 - 2.51	—	
7.62 (300")	4.572	6.096	16.88	26.71	26.61	40.27	40.18	63.70	0 - 3.02	—	
8.89 (350")	5.334	7.112	19.71	31.18	31.06	47.01	46.93	74.37	0 - 3.52	—	
10.16 (400")	6.096	8.128	22.54	35.64	35.52	53.74	53.68	85.04	0 - 4.02	—	
12.70 (500")	7.620	10.160	28.19	44.58	44.43	67.21	67.17	106.37	0 - 5.03	—	
15.24 (600")	9.144	12.192	33.85	53.51	53.35	80.68	80.67	127.70	0 - 6.04	—	

\*1 The throw ratio is based on the value during projection of 2.03 m (80") projected image size. When the fixed-focus lens (Model No.: ET-DLE030) is attached, it is based on the value during projection of 2.54 m (100") projected image size.

\*2 When the fixed-focus lens (Model No.: ET-DLE030) is attached, the projection relation between the screen and the projector differs from that of other lenses. Refer to "For fixed-focus lens (Model No.: ET-DLE030)" (➡ page 33) for details.

\*3 When the fixed-focus lens (Model No.: ET-DLE055) is attached, the lens shift is not possible, therefore the height position (H) becomes SH/2.

For PT-DW750

■ When the image aspect ratio is 16:10

(Unit: m)

Lens type			Standard zoom lens		Optional lens							
					Fixed-focus lens			Ultra short focus zoom lens		Short focus zoom lens		
Projection lens Model No.			—		ET-DLE030*2		ET-DLE055	ET-DLE080/ ET-DLE085		ET-DLE150		
Throw ratio*1			1.8-2.5:1		0.40:1		0.8:1	0.8-1.0:1		1.4-2.0:1		
Projected image size			Projection distance (L)		Projection distance (L1)	Distance between projector and screen		Projection distance (L)				
Diagonal (SD)	Height (SH)	Width (SW)	Min. (LW)	Max. (LT)		(L4)	(A1)	Fixed	Min. (LW)	Max. (LT)	Min. (LW)	Max. (LT)
1.27 (50")	0.673	1.077	1.91	2.70	—	—	—	0.87	0.87	1.09	1.45	2.12
1.52 (60")	0.808	1.292	2.31	3.26	—	—	—	1.06	1.05	1.32	1.75	2.55
1.78 (70")	0.942	1.508	2.71	3.81	—	—	—	1.24	1.23	1.54	2.05	2.98
2.03 (80")	1.077	1.723	3.11	4.37	—	—	—	1.42	1.42	1.77	2.35	3.42
2.29 (90")	1.212	1.939	3.50	4.92	—	—	—	1.61	1.60	2.00	2.65	3.85
2.54 (100")	1.346	2.154	3.90	5.48	0.86	0.22	0.59	1.79	1.78	2.22	2.95	4.28
3.05 (120")	1.615	2.585	4.70	6.59	1.03	0.39	0.72	2.16	2.15	2.68	3.55	5.15
3.81 (150")	2.019	3.231	5.89	8.25	1.29	0.64	0.92	2.71	2.70	3.36	4.45	6.45
5.08 (200")	2.692	4.308	7.88	11.03	1.71	1.07	1.25	3.63	3.61	4.49	5.95	8.61
6.35 (250")	3.365	5.385	9.86	13.81	2.14	1.50	1.58	—	4.53	5.62	7.45	10.78
7.62 (300")	4.039	6.462	11.85	16.58	2.57	1.92	1.91	—	5.45	6.76	8.95	12.95
8.89 (350")	4.712	7.539	13.84	19.36	3.00	2.35	2.24	—	6.36	7.89	10.46	15.11
10.16 (400")	5.385	8.616	15.83	22.13	—	—	—	—	7.28	9.02	11.96	17.28
12.70 (500")	6.731	10.770	19.80	27.68	—	—	—	—	9.11	11.29	14.96	21.61
15.24 (600")	8.077	12.923	23.78	33.23	—	—	—	—	10.94	13.55	17.96	25.94

Lens type			Optional lens						Height position (H)*3	
			Intermediate focus zoom lens		Long focus zoom lens		Ultra long focus zoom lens			
Projection lens Model No.			ET-DLE250		ET-DLE350		ET-DLE450		Standard zoom lens/ET-DLE080/ ET-DLE150/ ET-DLE250/ ET-DLE350/ ET-DLE450	
Throw ratio*1			2.4-3.8:1		3.8-5.7:1		5.6-9.0:1		ET-DLE055 (Fixed)	
Projected image size			Projection distance (L)							
Diagonal (SD)	Height (SH)	Width (SW)	Min. (LW)	Max. (LT)	Min. (LW)	Max. (LT)	Min. (LW)	Max. (LT)	Min. (LW)	Max. (LT)
1.27 (50")	0.673	1.077	2.54	4.06	4.00	6.11	5.96	9.59	-0.07 - 0.44	0.34
1.52 (60")	0.808	1.292	3.07	4.89	4.83	7.36	7.21	11.57	-0.08 - 0.53	0.40
1.78 (70")	0.942	1.508	3.59	5.72	5.65	8.61	8.46	13.55	-0.09 - 0.62	0.47
2.03 (80")	1.077	1.723	4.12	6.55	6.48	9.86	9.71	15.53	-0.11 - 0.71	0.54
2.29 (90")	1.212	1.939	4.64	7.38	7.31	11.11	10.96	17.51	-0.12 - 0.80	0.61
2.54 (100")	1.346	2.154	5.16	8.20	8.13	12.36	12.21	19.49	-0.13 - 0.89	0.67
3.05 (120")	1.615	2.585	6.21	9.86	9.79	14.86	14.72	23.45	-0.16 - 1.07	0.81
3.81 (150")	2.019	3.231	7.79	12.35	12.27	18.61	18.47	29.38	-0.20 - 1.33	1.01
5.08 (200")	2.692	4.308	10.41	16.49	16.40	24.85	24.73	39.28	-0.27 - 1.78	1.35
6.35 (250")	3.365	5.385	13.03	20.63	20.53	31.10	30.99	49.17	-0.34 - 2.22	—
7.62 (300")	4.039	6.462	15.65	24.77	24.67	37.34	37.25	59.06	-0.40 - 2.67	—
8.89 (350")	4.712	7.539	18.28	28.91	28.80	43.59	43.51	68.96	-0.47 - 3.11	—
10.16 (400")	5.385	8.616	20.90	33.05	32.94	49.84	49.76	78.85	-0.54 - 3.55	—
12.70 (500")	6.731	10.770	26.14	41.34	41.20	62.33	62.28	98.64	-0.67 - 4.44	—
15.24 (600")	8.077	12.923	31.39	49.62	49.47	74.82	74.80	118.42	-0.81 - 5.33	—

\*1 The throw ratio is based on the value during projection of 2.03 m (80") projected image size. When the fixed-focus lens (Model No.: ET-DLE030) is attached, it is based on the value during projection of 2.54 m (100") projected image size.

\*2 When the fixed-focus lens (Model No.: ET-DLE030) is attached, the projection relation between the screen and the projector differs from that of other lenses. Refer to "For fixed-focus lens (Model No.: ET-DLE030)" (➔ page 33) for details.

\*3 When the fixed-focus lens (Model No.: ET-DLE055) is attached, the lens shift is not possible, therefore the height position (H) becomes SH/2.

■ When the image aspect ratio is 16:9

(Unit: m)

Lens type			Standard zoom lens		Optional lens								
					Fixed-focus lens			Ultra short focus zoom lens		Short focus zoom lens			
Projection lens Model No.			—		ET-DLE030*2			ET-DLE055	ET-DLE080/ ET-DLE085		ET-DLE150		
Throw ratio*1			1.8-2.5:1		0.40:1			0.8:1	0.8-1.0:1		1.4-2.0:1		
Projected image size			Projection distance (L)		Projection distance (L1)	Distance between projector and screen		Projection distance (L)					
						(L4)	(A1)	Fixed	Min. (LW)	Max. (LT)	Min. (LW)	Max. (LT)	
1.27 (50")	0.623	1.107	1.97	2.78	—	—	—	0.90	0.89	1.12	1.49	2.18	
1.52 (60")	0.747	1.328	2.38	3.35	—	—	—	1.09	1.08	1.35	1.80	2.62	
1.78 (70")	0.872	1.550	2.79	3.92	—	—	—	1.27	1.27	1.59	2.11	3.07	
2.03 (80")	0.996	1.771	3.19	4.49	—	—	—	1.46	1.46	1.82	2.42	3.51	
2.29 (90")	1.121	1.992	3.60	5.06	—	—	—	1.65	1.65	2.05	2.72	3.96	
2.54 (100")	1.245	2.214	4.01	5.63	0.88	0.24	0.68	1.84	1.83	2.29	3.03	4.40	
3.05 (120")	1.494	2.657	4.83	6.77	1.06	0.41	0.83	2.22	2.21	2.75	3.65	5.29	
3.81 (150")	1.868	3.321	6.05	8.49	1.32	0.68	1.05	2.79	2.78	3.45	4.58	6.63	
5.08 (200")	2.491	4.428	8.10	11.34	1.76	1.12	1.43	3.73	3.72	4.61	6.12	8.86	
6.35 (250")	3.113	5.535	10.14	14.19	2.20	1.56	1.80	—	4.66	5.78	7.66	11.08	
7.62 (300")	3.736	6.641	12.18	17.04	2.64	2.00	2.17	—	5.60	6.94	9.21	13.31	
8.89 (350")	4.358	7.748	14.23	19.90	3.08	2.44	2.55	—	6.54	8.11	10.75	15.53	
10.16 (400")	4.981	8.855	16.27	22.75	—	—	—	—	7.48	9.27	12.29	17.76	
12.70 (500")	6.226	11.069	20.35	28.45	—	—	—	—	9.36	11.60	15.38	22.21	
15.24 (600")	7.472	13.283	24.44	34.16	—	—	—	—	11.24	13.93	18.46	26.66	

Lens type			Optional lens						Height position (H)*3			
			Intermediate focus zoom lens		Long focus zoom lens		Ultra long focus zoom lens					
Projection lens Model No.			ET-DLE250		ET-DLE350		ET-DLE450		Standard zoom lens/ET-DLE080/ ET-DLE085/ ET-DLE150/ ET-DLE250/ ET-DLE350/ ET-DLE450		ET-DLE055 (Fixed)	
Throw ratio*1			2.4-3.8:1		3.8-5.7:1		5.6-9.0:1					
Projected image size			Projection distance (L)									
			Diagonal (SD)	Height (SH)	Width (SW)	Min. (LW)	Max. (LT)	Min. (LW)	Max. (LT)	Min. (LW)	Max. (LT)	Min. (LW)
1.27 (50")	0.623	1.107	2.62	4.18	4.11	6.29	6.13	9.87	—	—	—	0.31
1.52 (60")	0.747	1.328	3.15	5.03	4.96	7.57	7.42	11.90	—	—	—	0.37
1.78 (70")	0.872	1.550	3.69	5.88	5.81	8.85	8.70	13.94	—	—	—	0.44
2.03 (80")	0.996	1.771	4.23	6.73	6.66	10.14	9.99	15.97	—	—	—	0.50
2.29 (90")	1.121	1.992	4.77	7.58	7.51	11.42	11.28	18.00	—	—	—	0.56
2.54 (100")	1.245	2.214	5.31	8.43	8.36	12.71	12.56	20.04	—	—	—	0.62
3.05 (120")	1.494	2.657	6.39	10.14	10.06	15.27	15.14	24.11	—	—	—	0.75
3.81 (150")	1.868	3.321	8.01	12.69	12.61	19.13	18.99	30.21	—	—	—	0.93
5.08 (200")	2.491	4.428	10.70	16.95	16.86	25.55	25.43	40.38	—	—	—	1.25
6.35 (250")	3.113	5.535	13.40	21.21	21.11	31.97	31.86	50.54	—	—	—	—
7.62 (300")	3.736	6.641	16.09	25.46	25.36	38.39	38.29	60.71	—	—	—	—
8.89 (350")	4.358	7.748	18.79	29.72	29.61	44.81	44.72	70.88	—	—	—	—
10.16 (400")	4.981	8.855	21.48	33.98	33.86	51.23	51.16	81.05	—	—	—	—
12.70 (500")	6.226	11.069	26.87	42.49	42.35	64.07	64.02	101.39	—	—	—	—
15.24 (600")	7.472	13.283	32.26	51.00	50.85	76.91	76.88	121.73	—	—	—	—

\*1 The throw ratio is based on the value during projection of 2.03 m (80") projected image size. When the fixed-focus lens (Model No.: ET-DLE030) is attached, it is based on the value during projection of 2.54 m (100") projected image size.

\*2 When the fixed-focus lens (Model No.: ET-DLE030) is attached, the projection relation between the screen and the projector differs from that of other lenses. Refer to "For fixed-focus lens (Model No.: ET-DLE030)" (➡ page 33) for details.

\*3 When the fixed-focus lens (Model No.: ET-DLE055) is attached, the lens shift is not possible, therefore the height position (H) becomes SH/2.



■ When the image aspect ratio is 4:3

(Unit: m)

Lens type			Standard zoom lens		Optional lens								
					Fixed-focus lens			Ultra short focus zoom lens		Short focus zoom lens			
Projection lens Model No.			—		ET-DLE030*2			ET-DLE055	ET-DLE080/ ET-DLE085		ET-DLE150		
Throw ratio*1			2.2-3.0:1		0.48:1			1.0:1	1.0-1.2:1		1.6-2.4:1		
Projected image size			Projection distance (L)		Projection distance (L1)	Distance between projector and screen		Projection distance (L)					
						(L4)	(A1)	Fixed	Min. (LW)	Max. (LT)	Min. (LW)	Max. (LT)	
1.27 (50")	0.762	1.016	2.18	3.07	—	—	—	0.99	0.99	1.24	1.65	2.40	
1.52 (60")	0.914	1.219	2.63	3.70	—	—	—	1.20	1.20	1.50	1.99	2.89	
1.78 (70")	1.067	1.422	3.08	4.33	—	—	—	1.41	1.40	1.75	2.33	3.38	
2.03 (80")	1.219	1.626	3.53	4.95	—	—	—	1.62	1.61	2.01	2.67	3.87	
2.29 (90")	1.372	1.829	3.98	5.58	—	—	—	1.82	1.82	2.26	3.00	4.36	
2.54 (100")	1.524	2.032	4.42	6.21	0.97	0.33	0.68	2.03	2.03	2.52	3.34	4.85	
3.05 (120")	1.829	2.438	5.32	7.47	1.17	0.52	0.83	2.45	2.44	3.03	4.02	5.83	
3.81 (150")	2.286	3.048	6.67	9.35	1.46	0.81	1.05	3.07	3.06	3.80	5.04	7.31	
5.08 (200")	3.048	4.064	8.92	12.49	1.94	1.30	1.42	4.11	4.10	5.09	6.74	9.76	
6.35 (250")	3.810	5.080	11.17	15.64	2.42	1.78	1.80	—	5.13	6.37	8.44	12.21	
7.62 (300")	4.572	6.096	13.42	18.78	2.91	2.26	2.17	—	6.17	7.65	10.14	14.66	
8.89 (350")	5.334	7.112	15.67	21.92	3.39	2.75	2.55	—	7.21	8.93	11.84	17.11	
10.16 (400")	6.096	8.128	17.92	25.06	—	—	—	—	8.24	10.22	13.54	19.56	
12.70 (500")	7.620	10.160	22.42	31.34	—	—	—	—	10.31	12.78	16.94	24.47	
15.24 (600")	9.144	12.192	26.92	37.63	—	—	—	—	12.39	15.35	20.34	29.37	

Lens type			Optional lens						Height position (H)*3	
			Intermediate focus zoom lens		Long focus zoom lens		Ultra long focus zoom lens			
Projection lens Model No.			ET-DLE250		ET-DLE350		ET-DLE450		Standard zoom lens/ET-DLE080/ ET-DLE085/ ET-DLE150/ ET-DLE250/ ET-DLE350/ ET-DLE450	ET-DLE055 (Fixed)
Throw ratio*1			2.9-4.6:1		4.5-6.9:1		6.8-10.8:1			
Projected image size			Projection distance (L)							
			Diagonal (SD)	Height (SH)	Width (SW)	Min. (LW)	Max. (LT)	Min. (LW)	Max. (LT)	Min. (LW)
1.27 (50")	0.762	1.016	2.89	4.61	4.54	6.94	6.78	10.90	-0.08 - 0.50	0.38
1.52 (60")	0.914	1.219	3.48	5.55	5.48	8.35	8.20	13.14	-0.09 - 0.60	0.46
1.78 (70")	1.067	1.422	4.08	6.48	6.42	9.76	9.61	15.38	-0.11 - 0.70	0.53
2.03 (80")	1.219	1.626	4.67	7.42	7.35	11.18	11.03	17.62	-0.12 - 0.80	0.61
2.29 (90")	1.372	1.829	5.26	8.36	8.29	12.59	12.45	19.86	-0.14 - 0.91	0.69
2.54 (100")	1.524	2.032	5.86	9.30	9.22	14.01	13.87	22.10	-0.15 - 1.01	0.76
3.05 (120")	1.829	2.438	7.04	11.17	11.09	16.83	16.70	26.58	-0.18 - 1.21	0.91
3.81 (150")	2.286	3.048	8.82	13.98	13.90	21.08	20.95	33.30	-0.23 - 1.51	1.14
5.08 (200")	3.048	4.064	11.79	18.67	18.58	28.15	28.03	44.49	-0.30 - 2.01	1.52
6.35 (250")	3.810	5.080	14.76	23.36	23.26	35.22	35.12	55.69	-0.38 - 2.51	—
7.62 (300")	4.572	6.096	17.73	28.05	27.94	42.29	42.20	66.89	-0.46 - 3.02	—
8.89 (350")	5.334	7.112	20.70	32.74	32.62	49.36	49.28	78.09	-0.53 - 3.52	—
10.16 (400")	6.096	8.128	23.67	37.42	37.30	56.43	56.37	89.29	-0.61 - 4.02	—
12.70 (500")	7.620	10.160	29.60	46.80	46.65	70.57	70.53	111.68	-0.76 - 5.03	—
15.24 (600")	9.144	12.192	35.54	56.17	56.01	84.71	84.70	134.08	-0.91 - 6.04	—

\*1 The throw ratio is based on the value during projection of 2.03 m (80") projected image size. When the fixed-focus lens (Model No.: ET-DLE030) is attached, it is based on the value during projection of 2.54 m (100") projected image size.

\*2 When the fixed-focus lens (Model No.: ET-DLE030) is attached, the projection relation between the screen and the projector differs from that of other lenses. Refer to "For fixed-focus lens (Model No.: ET-DLE030)" (➡ page 33) for details.

\*3 When the fixed-focus lens (Model No.: ET-DLE055) is attached, the lens shift is not possible, therefore the height position (H) becomes SH/2.

For PT-DX820

■ When the image aspect ratio is 4:3

(Unit: m)

Lens type			Standard zoom lens		Optional lens							
					Fixed-focus lens			Ultra short focus zoom lens		Short focus zoom lens		
Projection lens Model No.			—		ET-DLE030*2		ET-DLE055	ET-DLE080/ ET-DLE085		ET-DLE150		
Throw ratio*1			1.8-2.5:1		0.39:1		0.8:1	0.8-1.0:1		1.3-2.0:1		
Projected image size			Projection distance (L)		Projection distance (L1)	Distance between projector and screen		Projection distance (L)				
Diagonal (SD)	Height (SH)	Width (SW)	Min. (LW)	Max. (LT)		(L4)	(A1)	Fixed	Min. (LW)	Max. (LT)	Min. (LW)	Max. (LT)
1.27 (50")	0.762	1.016	1.78	2.51	—	—	—	0.81	0.81	1.01	1.34	1.97
1.52 (60")	0.914	1.219	2.15	3.03	—	—	—	0.98	0.98	1.22	1.62	2.37
1.78 (70")	1.067	1.422	2.52	3.55	—	—	—	1.15	1.15	1.43	1.90	2.77
2.03 (80")	1.219	1.626	2.89	4.06	—	—	—	1.32	1.32	1.64	2.18	3.18
2.29 (90")	1.372	1.829	3.26	4.58	—	—	—	1.49	1.49	1.85	2.46	3.58
2.54 (100")	1.524	2.032	3.63	5.10	0.80	0.16	0.41	1.66	1.66	2.07	2.74	3.98
3.05 (120")	1.829	2.438	4.37	6.13	0.96	0.32	0.51	2.01	2.00	2.49	3.30	4.79
3.81 (150")	2.286	3.048	5.48	7.68	1.20	0.55	0.65	2.52	2.51	3.12	4.14	6.00
5.08 (200")	3.048	4.064	7.33	10.26	1.60	0.95	0.89	3.38	3.36	4.18	5.54	8.02
6.35 (250")	3.810	5.080	9.18	12.85	1.99	1.35	1.13	—	4.21	5.23	6.94	10.03
7.62 (300")	4.572	6.096	11.03	15.43	2.39	1.75	1.37	—	5.07	6.29	8.33	12.05
8.89 (350")	5.334	7.112	12.88	18.02	2.79	2.15	1.61	—	5.92	7.34	9.73	14.07
10.16 (400")	6.096	8.128	14.73	20.60	—	—	—	—	6.77	8.40	11.13	16.08
12.70 (500")	7.620	10.160	18.43	25.77	—	—	—	—	8.48	10.51	13.92	20.12
15.24 (600")	9.144	12.192	22.13	30.94	—	—	—	—	10.18	12.62	16.72	24.15

Lens type			Optional lens						Height position (H)*3		
			Intermediate focus zoom lens		Long focus zoom lens		Ultra long focus zoom lens				
Projection lens Model No.			ET-DLE250		ET-DLE350		ET-DLE450		Standard zoom lens/ ET-DLE150/ ET-DLE250/ ET-DLE350/ ET-DLE450	ET-DLE080/ ET-DLE085	ET-DLE055 (Fixed)
Throw ratio*1			2.4-3.7:1		3.7-5.6:1		5.5-8.9:1				
Projected image size			Projection distance (L)								
Diagonal (SD)	Height (SH)	Width (SW)	Min. (LW)	Max. (LT)	Min. (LW)	Max. (LT)	Min. (LW)	Max. (LT)			
1.27 (50")	0.762	1.016	2.36	3.78	3.71	5.68	5.52	8.91	0 - 0.48	0.04 - 0.48	0.38
1.52 (60")	0.914	1.219	2.85	4.55	4.48	6.84	6.69	10.75	0 - 0.58	0.05 - 0.58	0.46
1.78 (70")	1.067	1.422	3.34	5.32	5.25	8.01	7.86	12.60	0 - 0.67	0.05 - 0.67	0.53
2.03 (80")	1.219	1.626	3.83	6.09	6.02	9.17	9.02	14.44	0 - 0.77	0.06 - 0.77	0.61
2.29 (90")	1.372	1.829	4.31	6.86	6.79	10.33	10.19	16.28	0 - 0.86	0.07 - 0.86	0.69
2.54 (100")	1.524	2.032	4.80	7.63	7.56	11.50	11.35	18.12	0 - 0.96	0.08 - 0.96	0.76
3.05 (120")	1.829	2.438	5.78	9.17	9.10	13.82	13.68	21.81	0 - 1.15	0.09 - 1.15	0.91
3.81 (150")	2.286	3.048	7.24	11.49	11.41	17.31	17.18	27.33	0 - 1.44	0.11 - 1.44	1.14
5.08 (200")	3.048	4.064	9.69	15.34	15.26	23.13	23.00	36.54	0 - 1.92	0.15 - 1.92	1.52
6.35 (250")	3.810	5.080	12.13	19.20	19.11	28.94	28.83	45.75	0 - 2.40	0.19 - 2.40	—
7.62 (300")	4.572	6.096	14.57	23.06	22.96	34.76	34.66	54.97	0 - 2.88	0.23 - 2.88	—
8.89 (350")	5.334	7.112	17.01	26.91	26.80	40.57	40.48	64.18	0 - 3.36	0.27 - 3.36	—
10.16 (400")	6.096	8.128	19.45	30.77	30.65	46.39	46.31	73.39	0 - 3.84	0.30 - 3.84	—
12.70 (500")	7.620	10.160	24.33	38.48	38.35	58.02	57.96	91.81	0 - 4.80	0.38 - 4.80	—
15.24 (600")	9.144	12.192	29.22	46.19	46.05	69.65	69.61	110.23	0 - 5.76	0.46 - 5.76	—

\*1 The throw ratio is based on the value during projection of 2.03 m (80") projected image size. When the fixed-focus lens (Model No.: ET-DLE030) is attached, it is based on the value during projection of 2.54 m (100") projected image size.

\*2 When the fixed-focus lens (Model No.: ET-DLE030) is attached, the projection relation between the screen and the projector differs from that of other lenses. Refer to "For fixed-focus lens (Model No.: ET-DLE030)" (▶ page 33) for details.

\*3 When the fixed-focus lens (Model No.: ET-DLE055) is attached, the lens shift is not possible. The height position (H) becomes SH/2.

■ When the image aspect ratio is 16:9

(Unit: m)

Lens type			Standard zoom lens		Optional lens							
					Fixed-focus lens			Ultra short focus zoom lens		Short focus zoom lens		
Projection lens Model No.			—		ET-DLE030*2			ET-DLE055	ET-DLE080/ ET-DLE085		ET-DLE150	
Throw ratio*1			1.8-2.5:1		0.39:1			0.8:1	0.8-1.0:1		1.3-2.0:1	
Projected image size			Projection distance (L)		Projection distance (L1)	Distance between projector and screen		Projection distance (L)				
						(L4)	(A1)	Fixed	Min. (LW)	Max. (LT)	Min. (LW)	Max. (LT)
1.27 (50")	0.623	1.107	1.94	2.74	—	—	—	0.88	0.88	1.11	1.47	2.15
1.52 (60")	0.747	1.328	2.34	3.31	—	—	—	1.07	1.07	1.34	1.77	2.59
1.78 (70")	0.872	1.550	2.75	3.87	—	—	—	1.26	1.25	1.57	2.08	3.03
2.03 (80")	0.996	1.771	3.15	4.43	—	—	—	1.44	1.44	1.79	2.38	3.47
2.29 (90")	1.121	1.992	3.55	4.99	—	—	—	1.63	1.62	2.02	2.69	3.90
2.54 (100")	1.245	2.214	3.96	5.56	0.87	0.23	0.66	1.82	1.81	2.25	2.99	4.34
3.05 (120")	1.494	2.657	4.76	6.68	1.04	0.40	0.81	2.19	2.18	2.71	3.60	5.22
3.81 (150")	1.868	3.321	5.97	8.37	1.31	0.66	1.03	2.75	2.74	3.40	4.51	6.54
5.08 (200")	2.491	4.428	7.99	11.19	1.74	1.09	1.39	3.68	3.67	4.55	6.04	8.74
6.35 (250")	3.113	5.535	10.01	14.00	2.17	1.53	1.75	—	4.60	5.70	7.56	10.93
7.62 (300")	3.736	6.641	12.02	16.82	2.61	1.96	2.12	—	5.52	6.85	9.08	13.13
8.89 (350")	4.358	7.748	14.04	19.63	3.04	2.39	2.48	—	6.45	8.00	10.61	15.33
10.16 (400")	4.981	8.855	16.05	22.45	—	—	—	—	7.38	9.15	12.13	17.53
12.70 (500")	6.226	11.069	20.09	28.08	—	—	—	—	9.24	11.45	15.17	21.92
15.24 (600")	7.472	13.283	24.12	33.71	—	—	—	—	11.10	13.75	18.22	26.31

Lens type			Optional lens						Height position (H)*3		
			Intermediate focus zoom lens		Long focus zoom lens		Ultra long focus zoom lens				
Projection lens Model No.			ET-DLE250		ET-DLE350		ET-DLE450		Standard zoom lens/ ET-DLE150/ ET-DLE250/ ET-DLE350/ ET-DLE450	ET-DLE080/ ET-DLE085	ET-DLE055 (Fixed)
Throw ratio*1			2.4-3.8:1		3.7-5.6:1		5.6-8.9:1				
Projected image size			Projection distance (L)						Min. (LW)	Max. (LT)	
			Min. (LW)	Max. (LT)	Min. (LW)	Max. (LT)	Min. (LW)	Max. (LT)			
1.27 (50")	0.623	1.107	2.58	4.12	4.06	6.20	6.05	9.74	-0.21 - 0.52	-0.16 - 0.52	0.31
1.52 (60")	0.747	1.328	3.11	4.96	4.90	7.47	7.32	11.74	-0.25 - 0.63	-0.19 - 0.63	0.37
1.78 (70")	0.872	1.550	3.64	5.80	5.73	8.74	8.58	13.75	-0.29 - 0.73	-0.23 - 0.73	0.44
2.03 (80")	0.996	1.771	4.18	6.64	6.57	10.00	9.85	15.76	-0.33 - 0.84	-0.26 - 0.84	0.50
2.29 (90")	1.121	1.992	4.71	7.48	7.41	11.27	11.12	17.76	-0.37 - 0.94	-0.29 - 0.94	0.56
2.54 (100")	1.245	2.214	5.24	8.32	8.25	12.54	12.39	19.77	-0.41 - 1.05	-0.32 - 1.05	0.62
3.05 (120")	1.494	2.657	6.30	10.00	9.93	15.07	14.93	23.78	-0.49 - 1.26	-0.39 - 1.26	0.75
3.81 (150")	1.868	3.321	7.90	12.52	12.44	18.87	18.74	29.81	-0.62 - 1.57	-0.49 - 1.57	0.93
5.08 (200")	2.491	4.428	10.56	16.72	16.64	25.21	25.09	39.84	-0.82 - 2.09	-0.65 - 2.09	1.25
6.35 (250")	3.113	5.535	13.22	20.93	20.83	31.54	31.44	49.88	-1.03 - 2.62	-0.81 - 2.62	—
7.62 (300")	3.736	6.641	15.88	25.13	25.02	37.88	37.78	59.91	-1.23 - 3.14	-0.97 - 3.14	—
8.89 (350")	4.358	7.748	18.54	29.33	29.22	44.22	44.13	69.95	-1.44 - 3.66	-1.13 - 3.66	—
10.16 (400")	4.981	8.855	21.20	33.53	33.41	50.55	50.48	79.98	-1.64 - 4.18	-1.30 - 4.18	—
12.70 (500")	6.226	11.069	26.52	41.93	41.79	63.22	63.17	100.05	-2.05 - 5.23	-1.62 - 5.23	—
15.24 (600")	7.472	13.283	31.84	50.33	50.18	75.89	75.87	120.12	-2.47 - 6.28	-1.94 - 6.28	—

\*1 The throw ratio is based on the value during projection of 2.03 m (80") projected image size. When the fixed-focus lens (Model No.: ET-DLE030) is attached, it is based on the value during projection of 2.54 m (100") projected image size.  
 \*2 When the fixed-focus lens (Model No.: ET-DLE030) is attached, the projection relation between the screen and the projector differs from that of other lenses. Refer to "For fixed-focus lens (Model No.: ET-DLE030)" (▶ page 33) for details.  
 \*3 When the fixed-focus lens (Model No.: ET-DLE055) is attached, the lens shift is not possible. The height position (H) becomes SH/2.

**Formula to calculate projection distance per projection lens**

To use a projected image size not listed in this manual, check the projected image size SD (m) and use the respective formula to calculate projection distance.

The unit of all the formulae is m. (Values obtained by the following calculation formulae contain a slight error.)

When calculating a projection distance using image size designation (value in inches), multiply the value in inches by 0.0254 and substitute it into SD in the formula for calculating the projection distance.

**For PT-DZ780**

■ **Standard zoom lens**

Projection lens Model No.	Throw ratio	Aspect ratio	Projection distance (L) formula	
			Min. (LW)	Max. (LT)
—	1.7 - 2.4:1	16:10	= 1.4906 x SD – 0.0746	= 2.0814 x SD – 0.0725
	1.7 - 2.4:1	16:9	= 1.5320 x SD – 0.0746	= 2.1393 x SD – 0.0725
	2.1 - 2.9:1	4:3	= 1.6874 x SD – 0.0746	= 2.3563 x SD – 0.0725

■ **Zoom lens**

Projection lens Model No.	Throw ratio	Aspect ratio	Projection distance (L) formula	
			Min. (LW)	Max. (LT)
ET-DLE080/ ET-DLE085	0.8 - 1.0:1	16:10	= 0.6865 x SD – 0.0471	= 0.8498 x SD – 0.0442
	0.8 - 1.0:1	16:9	= 0.7056 x SD – 0.0471	= 0.8735 x SD – 0.0442
	0.9 - 1.2:1	4:3	= 0.7772 x SD – 0.0471	= 0.9621 x SD – 0.0442
ET-DLE150	1.3 - 1.9:1	16:10	= 1.1259 x SD – 0.0540	= 1.6243 x SD – 0.0498
	1.3 - 1.9:1	16:9	= 1.1572 x SD – 0.0540	= 1.6695 x SD – 0.0498
	1.6 - 2.3:1	4:3	= 1.2747 x SD – 0.0540	= 1.8388 x SD – 0.0498
ET-DLE250	2.3 - 3.6:1	16:10	= 1.9665 x SD – 0.0800	= 3.1059 x SD – 0.0792
	2.3 - 3.6:1	16:9	= 2.0212 x SD – 0.0800	= 3.1923 x SD – 0.0792
	2.7 - 4.3:1	4:3	= 2.2263 x SD – 0.0800	= 3.5161 x SD – 0.0792
ET-DLE350	3.6 - 5.4:1	16:10	= 3.1000 x SD – 0.1351	= 4.6843 x SD – 0.1346
	3.6 - 5.4:1	16:9	= 3.1862 x SD – 0.1351	= 4.8146 x SD – 0.1346
	4.3 - 6.5:1	4:3	= 3.5094 x SD – 0.1351	= 5.3030 x SD – 0.1346
ET-DLE450	5.4 - 8.6:1	16:10	= 4.6931 x SD – 0.3017	= 7.4193 x SD – 0.2991
	5.4 - 8.6:1	16:9	= 4.8236 x SD – 0.3017	= 7.6256 x SD – 0.2991
	6.5 - 10.3:1	4:3	= 5.3129 x SD – 0.3017	= 8.3992 x SD – 0.2991

■ **For fixed-focus lens (Model No.: ET-DLE055)**

Projection lens Model No.	Throw ratio	Aspect ratio	Projection distance (L) formula
ET-DLE055	0.8:1	16:10	= 0.6893 x SD – 0.0476
	0.8:1	16:9	= 0.7084 x SD – 0.0476
	0.9:1	4:3	= 0.7803 x SD – 0.0476

■ **For fixed-focus lens (Model No.: ET-DLE030)**

Projection lens Model No.	Throw ratio	Aspect ratio	Projection distance (L1) formula	Formula for distance between projector and screen (A1)
ET-DLE030	0.38:1	16:10	= 0.3205 x SD + 0.0047	= 0.1977 x SD – 0.0671
	0.38:1	16:9	= 0.3294 x SD + 0.0047	= 0.2304 x SD – 0.0671
	0.46:1	4:3	= 0.3628 x SD + 0.0047	= 0.2238 x SD – 0.0671

For PT-DW750

■ Standard zoom lens

Projection lens Model No.	Throw ratio	Aspect ratio	Projection distance (L) formula	
			Min. (LW)	Max. (LT)
—	1.8 - 2.5:1	16:10	= 1.5651 x SD - 0.0746	= 2.1855 x SD - 0.0725
	1.8 - 2.5:1	16:9	= 1.6086 x SD - 0.0746	= 2.2462 x SD - 0.0725
	2.2 - 3.0:1	4:3	= 1.7715 x SD - 0.0746	= 2.4736 x SD - 0.0725

■ Zoom lens

Projection lens Model No.	Throw ratio	Aspect ratio	Projection distance (L) formula	
			Min. (LW)	Max. (LT)
ET-DLE080/ ET-DLE085	0.8 - 1.0:1	16:10	= 0.7209 x SD - 0.0471	= 0.8923 x SD - 0.0442
	0.8 - 1.0:1	16:9	= 0.7409 x SD - 0.0471	= 0.9171 x SD - 0.0442
	1.0 - 1.2:1	4:3	= 0.8159 x SD - 0.0471	= 1.0100 x SD - 0.0442
ET-DLE150	1.4 - 2.0:1	16:10	= 1.1822 x SD - 0.0540	= 1.7055 x SD - 0.0498
	1.4 - 2.0:1	16:9	= 1.2151 x SD - 0.0540	= 1.7529 x SD - 0.0498
	1.6 - 2.4:1	4:3	= 1.3381 x SD - 0.0540	= 1.9304 x SD - 0.0498
ET-DLE250	2.4 - 3.8:1	16:10	= 2.0649 x SD - 0.0800	= 3.2612 x SD - 0.0792
	2.4 - 3.8:1	16:9	= 2.1223 x SD - 0.0800	= 3.3519 x SD - 0.0792
	2.9 - 4.6:1	4:3	= 2.3371 x SD - 0.0800	= 3.6912 x SD - 0.0792
ET-DLE350	3.8 - 5.7:1	16:10	= 3.2550 x SD - 0.1351	= 4.9185 x SD - 0.1346
	3.8 - 5.7:1	16:9	= 3.3455 x SD - 0.1351	= 5.0553 x SD - 0.1346
	4.5 - 6.9:1	4:3	= 3.6842 x SD - 0.1351	= 5.5671 x SD - 0.1346
ET-DLE450	5.6 - 9.0:1	16:10	= 4.9277 x SD - 0.3017	= 7.7903 x SD - 0.2991
	5.6 - 9.0:1	16:9	= 5.0647 x SD - 0.3017	= 8.0069 x SD - 0.2991
	6.8 - 10.8:1	4:3	= 5.5775 x SD - 0.3017	= 8.8174 x SD - 0.2991

■ For fixed-focus lens (Model No.: ET-DLE055)

Projection lens Model No.	Throw ratio	Aspect ratio	Projection distance (L) formula
ET-DLE055	0.8:1	16:10	= 0.7237 x SD - 0.0476
	0.8:1	16:9	= 0.7438 x SD - 0.0476
	1.0:1	4:3	= 0.8191 x SD - 0.0476

■ For fixed-focus lens (Model No.: ET-DLE030)

Projection lens Model No.	Throw ratio	Aspect ratio	Projection distance (L1) formula	Formula for distance between projector and screen (A1)
ET-DLE030	0.40:1	16:10	= 0.3365 x SD + 0.0047	= 0.2597 x SD - 0.0690
	0.40:1	16:9	= 0.3459 x SD + 0.0047	= 0.2942 x SD - 0.0690
	0.48:1	4:3	= 0.3809 x SD + 0.0047	= 0.2941 x SD - 0.0690

For PT-DX820

■ Standard zoom lens

Projection lens Model No.	Throw ratio	Aspect ratio	Projection distance (L) formula	
			Min. (LW)	Max. (LT)
—	1.8 - 2.5:1	16:9	= 1.5875 x SD - 0.0746	= 2.2167 x SD - 0.0725
	1.8 - 2.5:1	4:3	= 1.4571 x SD - 0.0746	= 2.0346 x SD - 0.0725

■ Zoom lens

Projection lens Model No.	Throw ratio	Aspect ratio	Projection distance (L) formula	
			Min. (LW)	Max. (LT)
ET-DLE080/ ET-DLE085	0.8 - 1.0:1	16:9	= 0.7311 x SD - 0.0471	= 0.9051 x SD - 0.0442
	0.8 - 1.0:1	4:3	= 0.6711 x SD - 0.0471	= 0.8307 x SD - 0.0442
ET-DLE150	1.3 - 2.0:1	16:9	= 1.1991 x SD - 0.0540	= 1.7299 x SD - 0.0498
	1.3 - 2.0:1	4:3	= 1.1006 x SD - 0.0540	= 1.5878 x SD - 0.0498
ET-DLE250	2.4 - 3.8:1	16:9	= 2.0943 x SD - 0.0800	= 3.3078 x SD - 0.0792
	2.4 - 3.7:1	4:3	= 1.9224 x SD - 0.0800	= 3.0361 x SD - 0.0792
ET-DLE350	3.7 - 5.6:1	16:9	= 3.3015 x SD - 0.1351	= 4.9888 x SD - 0.1346
	3.7 - 5.6:1	4:3	= 3.0304 x SD - 0.1351	= 4.5791 x SD - 0.1346
ET-DLE450	5.6 - 8.9:1	16:9	= 4.9981 x SD - 0.3017	= 7.9015 x SD - 0.2991
	5.5 - 8.9:1	4:3	= 4.5876 x SD - 0.3017	= 7.2526 x SD - 0.2991

■ For fixed-focus lens (Model No.: ET-DLE055)

Projection lens Model No.	Throw ratio	Aspect ratio	Projection distance (L) formula
ET-DLE055	0.8:1	16:9	= 0.7340 x SD - 0.0476
	0.8:1	4:3	= 0.6738 x SD - 0.0476

■ For fixed-focus lens (Model No.: ET-DLE030)

Projection lens Model No.	Throw ratio	Aspect ratio	Projection distance (L1) formula	Formula for distance between projector and screen (A1)
ET-DLE030	0.39:1	16:9	= 0.3413 x SD + 0.0047	= 0.2866 x SD - 0.0665
	0.39:1	4:3	= 0.3133 x SD + 0.0047	= 0.1881 x SD - 0.0665

**Adjusting adjustable feet**

Install the projector on a flat surface so that the front of the projector is parallel to the screen surface and the projected image is rectangular.

If the screen is tilted downward, the projected image can be adjusted to be rectangular by adjusting the front adjustable feet. The adjustable feet can also be used to adjust the projector to be level when it is tilted in the horizontal direction.

Adjustable feet can be extended by turning them as shown in the figure. Turning them in the opposite direction will return them to the original position.

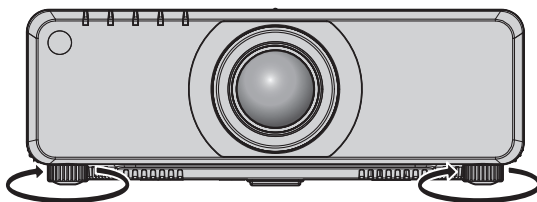

**Adjustable range**

Each adjustable feet: Approx. 30 mm (1-3/16")

**Attention**

- Heated air is expelled from the air exhaust port while the lamp is lit. Do not touch the air exhaust port directly when adjusting the adjustable feet. (➔ page 25)

## Removing/attaching the projection lens

Removing and attaching methods of the projection lens are same for both standard zoom lenses and optional lenses.

Move the projection lens to the home position before replacing or removing the projection lens. (➔ page 63)

### Attention

- Replace the projection lens after turning off the projector.
- Do not touch the electric contacts of the projection lens. Dust or dirt may cause poor contact.
- Do not touch the surface of the projection lens with your bare hands.
- Before attaching the projection lens, remove the lens cover attached to the projection lens.

### Note

- In case of the ultra short focus zoom lens (Model No.: ET-DLE080, ET-DLE085), attachment/removal procedures of the lens mount cover are different. Refer to the user manual supplied with ET-DLE080 or ET-DLE085.
- In case of the fixed-focus lens (Model No.: ET-DLE030), precautions on handling the lens and attachment/removal procedures of the lens mount cover are different. Refer to the Operating Instructions of ET-DLE030 for details.

### Removing the projection lens

Remove the projection lens using the following procedure.

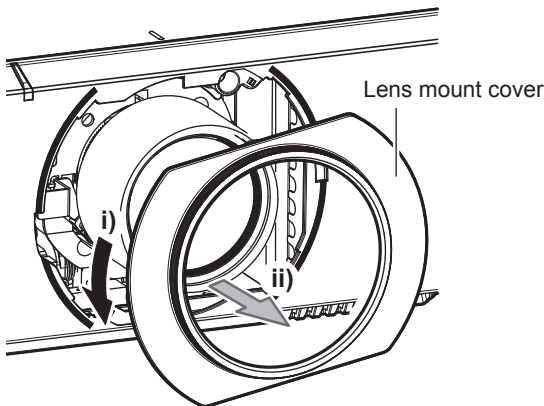

Fig. 1

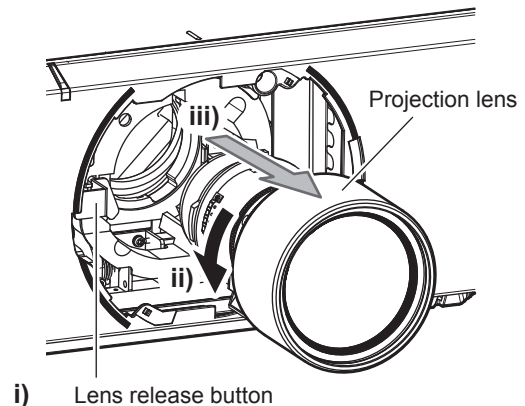

Fig. 2

- 1) Turn the lens mount cover counterclockwise and remove. (Fig. 1)
- 2) While keep pressing the lens release button, turn the projection lens counterclockwise to the end and remove. (Fig. 2)

### Attention

- Store the removed projection lens where it will be free from vibration and impact.

### Attaching the projection lens

Attach the projection lens using the following procedure.

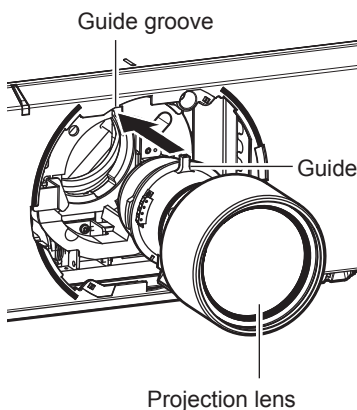

Fig. 1

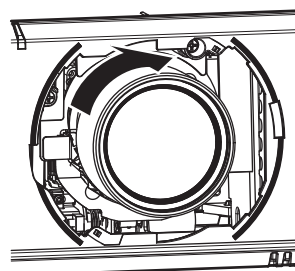

Fig. 2

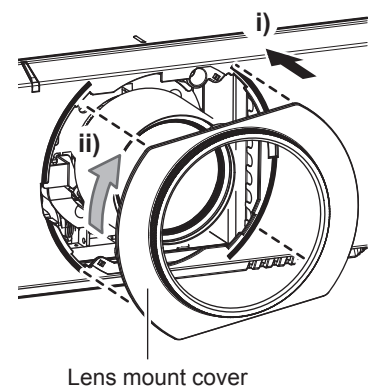

Fig. 3

- 1) **Remove the lens mount cover, and align the projection lens guide to the guide groove of the projector and insert to the end. (Fig. 1)**
- 2) **Turn the projection lens clockwise until it clicks. (Fig. 2)**
- 3) **Attach the lens mount cover. (Fig. 3)**
  - Align the lens mount cover and the projector at the dashed line positions in the figure to attach, and turn the lens mount cover clockwise to fix it to the projector.

---

**Attention**

---

- Turn the projection lens counterclockwise to confirm that it does not come out.



# Connecting

## Before connecting

- Before connecting, carefully read the operating instructions for the external device to be connected.
- Turn off the power of all devices before connecting cables.
- Take note of the following points before connecting the cables. Failure to do so may result in malfunctions.
  - When connecting a cable to a device connected to the projector or the projector itself, touch any nearby metallic objects to eliminate static electricity from your body before performing work.
  - Do not use unnecessarily long cables to connect a device to the projector or to the projector body. The longer the cable, the more susceptible to noise it becomes. Since using a cable while it is wound makes it act like an antenna, it is more susceptible to noise.
  - When connecting cables, connect GND first, then insert the connecting terminal of the connecting device in a straight manner.
- Acquire any connection cable necessary to connect the external device to the system that is neither supplied with the device nor available as an option.
- If video signals from video equipment contain too much jitter, the images on the screen may wobble. In this case, a time base corrector (TBC) must be connected.
- The projector accepts video signals, Y/C signals, YC<sub>B</sub>C<sub>R</sub>/YP<sub>B</sub>P<sub>R</sub> signals, analog RGB signals (synchronization signals are TTL level), and digital signals.
- Some computer models are not compatible with the projector.
- Use a cable compensator when you connect devices to the projector using long cables. Otherwise the image may not display properly.
- Refer to “List of compatible signals” (➔ page 186) for the types of video signals that can be used with the projector.

## <RGB 2 IN> terminal pin assignments and signal names

Outside view	Pin No.	Signal name	Pin No.	Signal name
<p>(11) → (15)</p> <p>(6) → (10)</p> <p>(1) → (5)</p>	(1)	R/P <sub>R</sub>	(9)	—
	(2)	G/Y	(10)	GND
	(3)	B/P <sub>B</sub>	(11)	GND
	(4)	—	(12)	DDC data
	(5)	GND	(13)	SYNC/HD
	(6)	GND	(14)	VD
	(7)	GND	(15)	DDC clock
	(8)	GND		

## <HDMI IN> terminal pin assignments and signal names

Outside view	Pin No.	Signal name	Pin No.	Signal name
<p>Even-numbered pins of (2) to (18)</p> <p>(2) → (18)</p> <p>(1) → (19)</p> <p>Odd-numbered pins of (1) to (19)</p>	(1)	T.M.D.S data 2+	(11)	T.M.D.S clock shield
	(2)	T.M.D.S data 2 shield	(12)	T.M.D.S clock-
	(3)	T.M.D.S data 2-	(13)	CEC
	(4)	T.M.D.S data 1+	(14)	—
	(5)	T.M.D.S data 1 shield	(15)	SCL
	(6)	T.M.D.S data 1-	(16)	SDA
	(7)	T.M.D.S data 0+	(17)	DDC/CEC GND
	(8)	T.M.D.S data 0 shield	(18)	+5 V
	(9)	T.M.D.S data 0-	(19)	Hot plug detection
	(10)	T.M.D.S clock+		

<DVI-D IN> terminal pin assignments and signal names

Outside view	Pin No.	Signal name	Pin No.	Signal name
	(1)	T.M.D.S data 2-	(13)	—
	(2)	T.M.D.S data 2+	(14)	+5 V
	(3)	T.M.D.S data 2/4 shield	(15)	GND
	(4)	—	(16)	Hot plug detection
	(5)	—	(17)	T.M.D.S data 0-
	(6)	DDC clock	(18)	T.M.D.S data 0+
	(7)	DDC data	(19)	T.M.D.S data 0/5 shield
	(8)	—	(20)	—
	(9)	T.M.D.S data 1-	(21)	—
	(10)	T.M.D.S clock1+	(22)	T.M.D.S clock shield
	(11)	T.M.D.S data 1/3 shield	(23)	T.M.D.S clock+
	(12)	—	(24)	T.M.D.S clock-

Connecting example: AV equipment

For <HDMI IN>/<DVI-D IN>/<RGB 1 IN> terminals

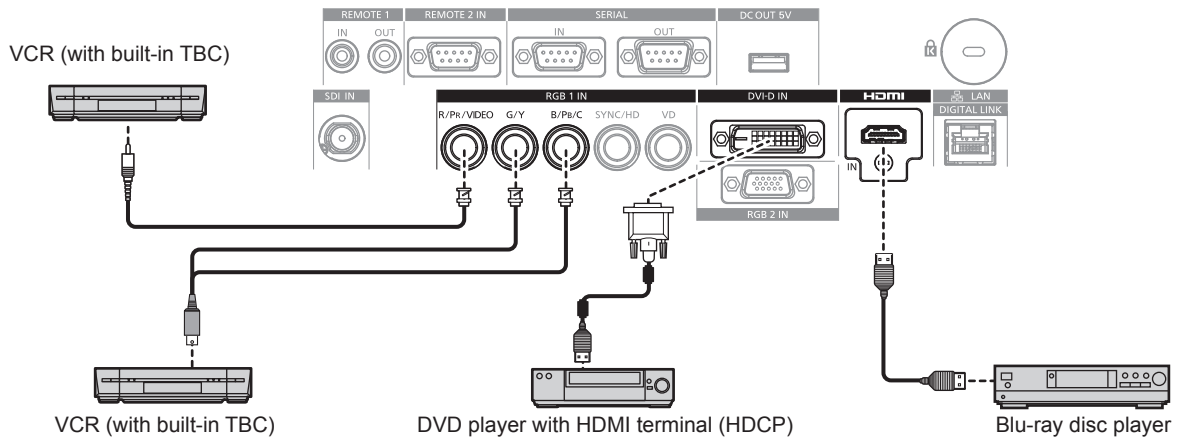

Attention

- Always use one of the following when connecting a VCR.
  - A VCR with built-in time base corrector (TBC)
  - A time base corrector (TBC) between the projector and the VCR
- If nonstandard burst signals are connected, the image may be distorted. In such a case, connect the time base corrector (TBC) between the projector and the external devices.

Note

- When inputting DVI-D, some external devices to be connected may require switching the setting using the [DISPLAY OPTION] menu → [DVI-D IN] → [EDID SELECT].
- The <DVI-D IN> terminal can be connected to HDMI- or DVI-D-compliant devices. However, images may not appear or may not be displayed properly on some devices.
- For an HDMI cable, use an HDMI High Speed cable that conforms to HDMI standards. If a cable that does not conform to HDMI standards is used, images may be interrupted or may not be displayed.
- The <HDMI IN> terminal of the projector can be connected to an external device equipped with a DVI-D terminal using an HDMI/DVI conversion cable. However, this may not function properly for some external devices, and images may not be displayed.
- The projector does not support VIERA Link (HDMI).
- When a video signal and Y/C signal are input, switch the setting using the [DISPLAY OPTION] menu → [RGB IN] → [RGB1 INPUT SETTING] (➔ page 98).

**For <SDI IN> terminal**

(Only for PT-DZ780)

Digital VCR for commercial use

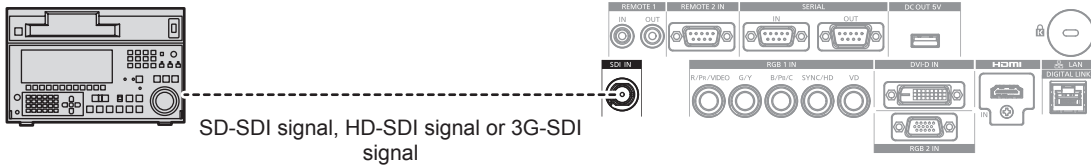

SD-SDI signal, HD-SDI signal or 3G-SDI signal

**Note**

- Use the [PICTURE] menu → [SYSTEM SELECTOR] to switch the input format.
- Some external devices to be connected require the [DISPLAY OPTION] menu → [SDI IN] to be set.
- Use a 5CFB or higher (such as 5CFB, or 7CFB) or a Belden 1694A or higher connection cable to properly transmit images. Use a connection cable of 100 m (328'1") length or less.
- When an unsteady signal is connected, an error in signal detection may occur. In such a case, use the [PICTURE] menu → [SYSTEM SELECTOR] to switch to a system that matches the signal format.

**Connecting example: Computers**

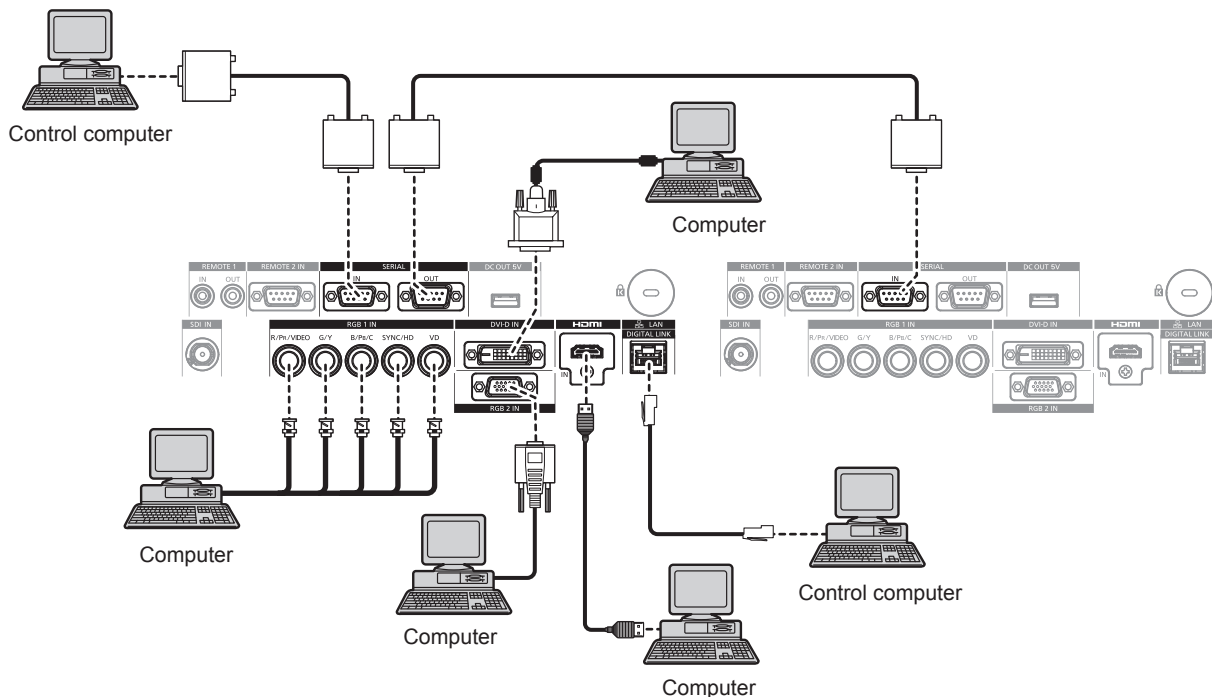

**Attention**

- When connecting the projector to a computer or an external device, use the power cord supplied with each device and commercially available shielded cables.

**Note**

- When inputting DVI-D, some external devices to be connected may require switching the setting using the [DISPLAY OPTION] menu → [DVI-D IN] → [EDID SELECT].
- For an HDMI cable, use an HDMI High Speed cable that conforms to HDMI standards. If a cable that does not conform to HDMI standards is used, images may be interrupted or may not be displayed.
- The <HDMI IN> terminal of the projector can be connected to an external device equipped with a DVI-D terminal using an HDMI/DVI conversion cable. However, this may not function properly for some external devices, and images may not be displayed.
- The <DVI-D IN> terminal supports single links only.
- When entering the SYNC ON GREEN signal, do not enter sync signals to the <SYNC/HD> terminal or the <VD> terminal.
- If you operate the projector using the computer with the resume feature (last memory), you may have to reset the resume feature to operate the projector.

## Connecting example using DIGITAL LINK

Twisted-pair-cable transmitters based on the communication standard HDBaseT™ such as the optional DIGITAL LINK output supported device (Model No.: ET-YFB100G, ET-YFB200G) use twisted pair cables to transmit input images, Ethernet, and serial control signals, and the projector can input those digital signals to the <DIGITAL LINK/LAN> terminal.

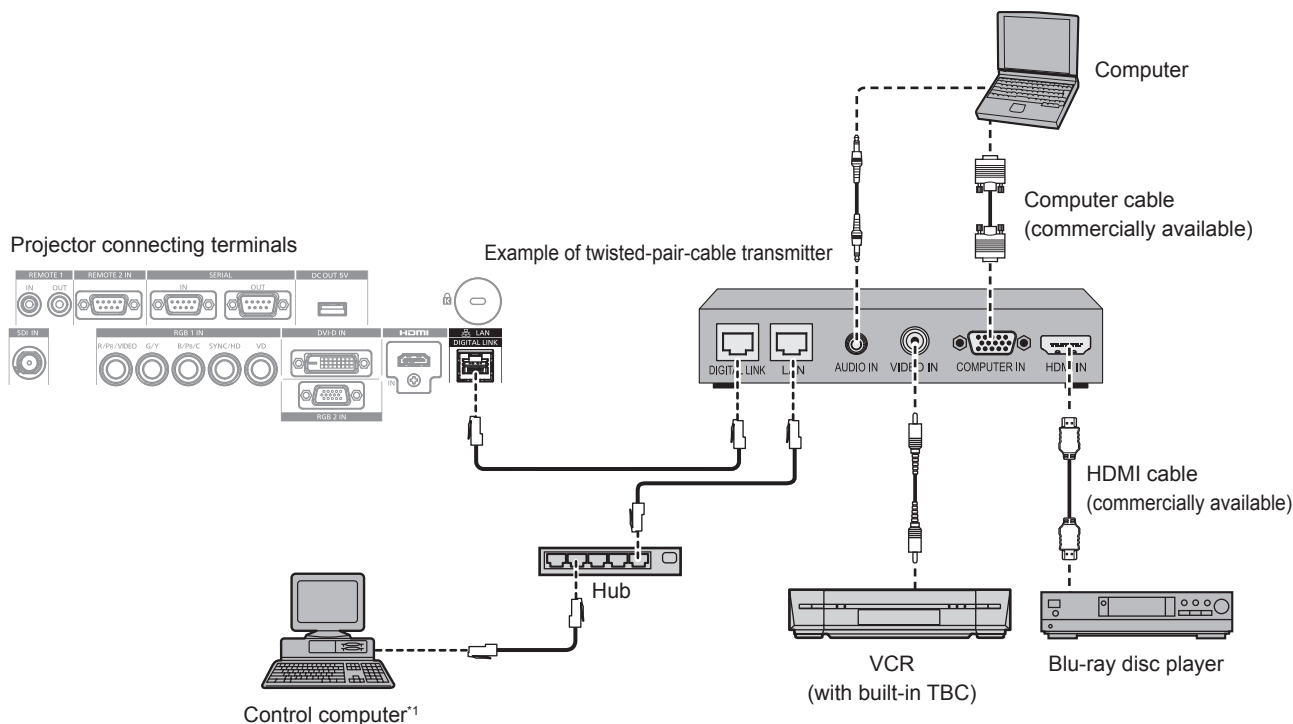

\*1 The control target will be the projector or the twisted-pair-cable transmitter. The control itself may not be possible depending on the twisted-pair-cable transmitter. Check the operating instructions of the device to be connected.

### Attention

- Always use one of the following when connecting a VCR.
  - A VCR with built-in time base corrector (TBC)
  - A time base corrector (TBC) between the projector and the VCR
- If nonstandard burst signals are connected, the image may be disrupted. In such a case, connect the time base corrector (TBC) between the projector and the external devices.
- Ask a qualified technician or your dealer to install the cable wiring for a twisted-pair-cable transmitter and the projector. Image may be disrupted if cable transmission characteristics cannot be obtained due to inadequate installation.
- For the LAN cable between the twisted-pair-cable transmitter and the projector, use a cable that meets the following criteria:
  - Compatible with CAT5e or higher
  - Shielded type (including connectors)
  - Straight-through
  - Single wire
- When laying cables between the twisted-pair-cable transmitter and the projector, check that cable characteristics are compatible with CAT5e or higher using tools such as a cable tester or cable analyzer. When a relay connector is used, include it in the measurement.
- Do not use a hub between the twisted-pair-cable transmitter and the projector.
- When connecting to the projector using a twisted-pair-cable transmitter (receiver) of other manufacturer, do not place another twisted-pair-cable transmitter between the twisted-pair-cable transmitter of other manufacturer and the projector. This may cause image to be disrupted.
- Do not pull cables forcefully. In addition, do not bend or fold cables unnecessarily.
- To reduce the effects of noise as much as possible, stretch out the cables between the twisted-pair-cable transmitter and the projector without any loops.
- Lay the cables between a twisted-pair-cable transmitter and the projector away from other cables, particularly power cables.
- When laying multiple cables, run them side by side along the shortest distance possible without bundling them together.
- After laying the cables, confirm that the value of [SIGNAL QUALITY] in the [NETWORK] menu → [DIGITAL LINK STATUS] is displayed in green to indicate normal quality. (► page 139)

### Note

- For an HDMI cable, use an HDMI High Speed cable that conforms to HDMI standards. If a cable that does not conform to HDMI standards is used, images may be interrupted or may not be displayed.
- The projector does not support VIERA Link (HDMI).
- The maximum transmission distance between the twisted-pair-cable transmitter and the projector is 100 m (328'1"). It is possible to transmit up to 150 m (492'2") if the twisted-pair-cable transmitter supports the long-reach communication method. If this distance is exceeded, image may be disrupted or a malfunction may occur in LAN communication. Please note that we do not support the use of the projector outside the maximum transmission distance. When connecting with the long reach, there may be a limitation to the video signal that can be transmitted or the distance depending on the specification of the twisted-pair-cable transmitter.

- For twisted-pair-cable transmitters of other manufacturers of which the operation has been verified with the projector, refer to the Panasonic website (<http://panasonic.net/avc/projector/>). Note that the verification for devices of other manufacturers has been made for the items set by Panasonic Corporation, and not all the operations have been verified. For operation or performance problems caused by the devices of other manufacturers, contact the respective manufacturers.

# Chapter 3 Basic Operations

---

This chapter describes basic operations to start with.

# Switching on/off the projector

## Connecting the power cord

Make sure that the supplied power cord is securely fixed to the projector body to prevent it from being removed easily.

Confirm that the <MAIN POWER> switch is on the <OFF> side before connecting the power cord.

For details of power cord handling, refer to “Read this first!” (➔ page 5).

## How to attach the power cord

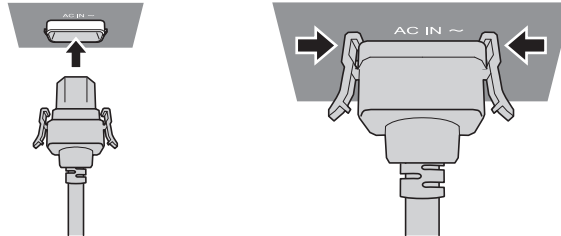

- 1) Check the shapes of the <AC IN> terminal on the side of the projector and the power cord connector, and insert the plug completely in the correct direction (until you hear the side tabs click in place).

## How to remove the power cord

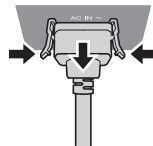

- 1) Confirm that the <MAIN POWER> switch on the side of the projector is on the <OFF> side, and remove the power plug from the outlet.
- 2) Remove the power cord connector from the <AC IN> terminal of the projector while pressing the side tabs.

## Power indicator

Displays the status of the power. Check the status of the power indicator <ON (G)/STANDBY (R)> before operating the projector.

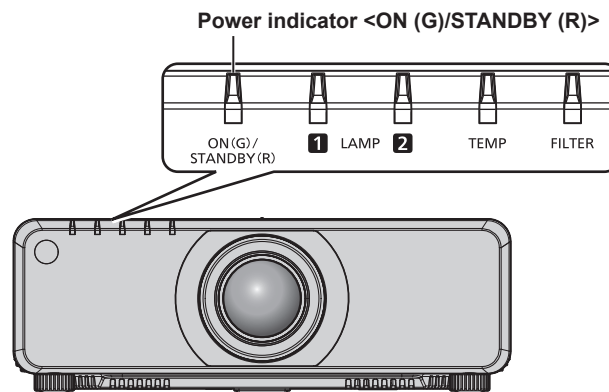

Indicator status		Projector status
Off		The main power is switched off.
Red	Lit	The power is switched off. (standby mode) Projection will start when the power on < > button is pressed. • The projector may not operate when the lamp indicators <LAMP1>/<LAMP2> or temperature indicator <TEMP> are blinking. (➔ page 162)
Green	Lit	Projecting.

Indicator status		Projector status
Orange	Lit	The projector is preparing to switch off the projector. The power is switched off after a while. (Changes to the standby mode.)

**Note**

- While the power indicator <ON (G)/STANDBY (R)> is lit in orange, the fan is running to cool the projector.
- For about 75 seconds after the projector is switched off and the luminous lamp cooling is started, the indicator will not light up even if the power is switched on. After the power indicator <ON (G)/STANDBY (R)> lights in red, turn on the power again.
- The projector consumes power even in standby mode (power indicator <ON (G)/STANDBY (R)> lit in red). Refer to “Power consumption” (➔ page 189) for the power consumption.
- The power indicator <ON (G)/STANDBY (R)> will blink if the projector receives a remote control signal.
- The power indicator <ON (G)/STANDBY (R)> will blink slowly in green while the shutter function is in use (shutter: closed).
- If the power indicator <ON (G)/STANDBY (R)> is blinking in red, consult your dealer.

**Switching on the projector**

When using the optional projection lens, attach the projection lens before switching on the projector.  
Remove the lens cover first.

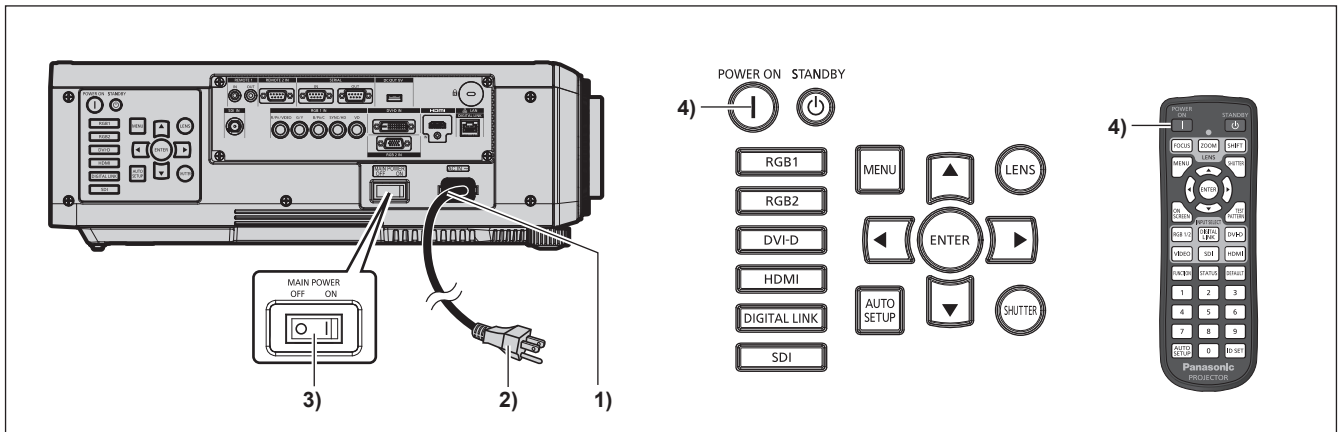

- 1) **Connect the power cord to the projector body.**
- 2) **Connect the power plug to an outlet.**
- 3) **Press the <ON> side of the <MAIN POWER> switch to turn on the power.**
  - The power indicator <ON (G)/STANDBY (R)> lights in red, and the projector enters the standby mode.
- 4) **Press the power on <|> button.**
  - The power indicator <ON (G)/STANDBY (R)> lights in green and the image is soon projected on the screen.

**Note**

- If the projector is switched on at around 0 °C (32 °F), a warm-up period of approximately 10 minutes may be necessary until an image is displayed. The temperature indicator <TEMP> lights during the warm-up period. When the warm-up is completed, the temperature indicator <TEMP> turns off and the projection starts. Refer to “When an indicator lights up” (➔ page 162) for the indicator status display.
- If the operating environment temperature is low and a warm-up takes more than 10 minutes, the projector will judge that a problem has occurred and the power will automatically be set to standby mode. If this happens, increase the operating environment temperature to 0 °C (32 °F) or higher, turn off the main power, and then switch on the power again.
- If the [PROJECTOR SETUP] menu → [STANDBY MODE] is set to [ECO], it may take approx. 10 seconds longer before the projector starts projecting after the power is turned on, compared with when [NORMAL] is set.
- If the [PROJECTOR SETUP] menu → [INITIAL STARTUP] is set to [LAST MEMORY] and the power is turned off by pressing the <OFF> side of the <MAIN POWER> switch or by using the circuit breaker directly while projecting during the last time of use, the power indicator <ON (G)/STANDBY (R)> lights in green and projection starts after a while when the power is turned on by pressing the <ON> side of the <MAIN POWER> switch with the power plug connected to the outlet, or by turning on the circuit breaker.



## When the initial setting screen is displayed

When the projector is switched on for the first time after purchase, as well as when [ALL USER DATA] is executed from the [PROJECTOR SETUP] menu → [INITIALIZE], the focus adjustment screen is displayed after projection starts, then the **[INITIAL SETTING]** screen is displayed. Set them according to the circumstances.

In other occasions, you can change the settings by menu operations.

If you press the <MENU> button while the **[INITIAL SETTING]** screen is displayed, you can go back to the previous screen.

## Focus adjustment

Adjust the focus to display the menu screen clearly.

You may also need to adjust the zoom and shift.

Refer to “Adjusting the focus, zoom, and shift” (➔ page 62) for details.

- 1) Press ▲▼◀▶ to adjust the focus.

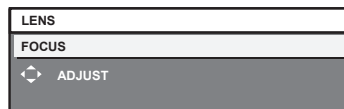

- 2) Press the <MENU> button to proceed to the initial setting.

## Initial setting (display language)

Select the language to show on the screen.

After completed the initial setting, you can change the display language from the [DISPLAY LANGUAGE] menu.

- 1) Press ▲▼ to select the display language.



- 2) Press the <ENTER> button to proceed to the initial setting.

### Initial setting (installation setting)

Set [PROJECTION METHOD] and [COOLING CONDITION] depending on the installation mode. Refer to “Installation mode” (➡ page 31) for details.

After completed the initial setting, you can change the settings of each item from the [PROJECTOR SETUP] menu.

- 1) Press ▲▼ to select an item.

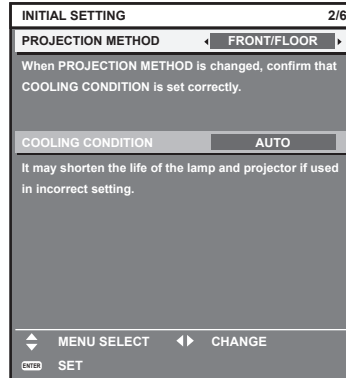

- 2) Press ◀▶ to switch the setting.
- 3) Press the <ENTER> button to proceed to the initial setting.

### Initial setting (standby mode)

Set the operation mode during standby. The factory default setting is [NORMAL], which allows you to use the network function during standby. To keep power consumption low during standby, set this function to [ECO]. After completed the initial setting, you can change the setting from the [PROJECTOR SETUP] menu → [STANDBY MODE].

- 1) Press ◀▶ to switch the setting.

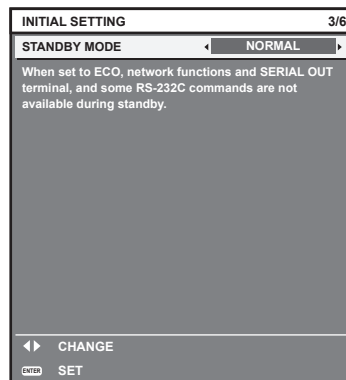

- 2) Press the <ENTER> button to proceed to the initial setting.

#### Note

- The preceding initial setting screen is displayed when the projector is switched on for the first time after purchase. If [ALL USER DATA] is executed from the [PROJECTOR SETUP] menu → [INITIALIZE], the setting of [STANDBY MODE] set before execution is displayed.

### Initial setting (screen setting)

Set the screen format (aspect ratio) and display position of the image. After completed the initial setting, you can change the settings of each item from the [DISPLAY OPTION] menu → [SCREEN SETTING].

- 1) Press ▲▼ to select an item.
- 2) Press ◀▶ to switch the setting.

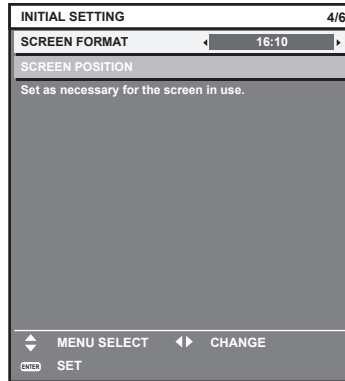

- 3) Press the <ENTER> button to proceed to the initial setting.

### Initial setting (time zone)

Set [TIME ZONE] according to the country or region where the projector is used.

After completed the initial setting, you can change the setting from the [PROJECTOR SETUP] menu → [DATE AND TIME]. The current settings are displayed in [LOCAL DATE] and [LOCAL TIME].

- 1) Press ◀▶ to switch the setting.

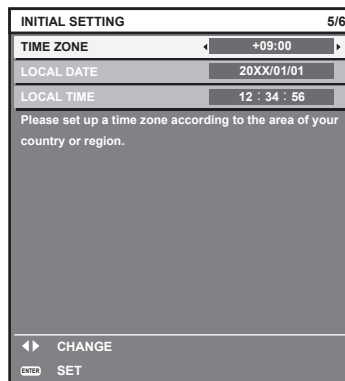

- 2) Press the <ENTER> button to proceed to the initial setting.

#### Note

- By default, the time zone of the projector is set to +09:00 (Japan and Korean Standard Time). Change the setting in the [PROJECTOR SETUP] menu → [DATE AND TIME] → [TIME ZONE] to the time zone of the region where you use the projector.

### Initial setting (date and time)

Set the local date and time. After completed the initial setting, you can change the setting from the [PROJECTOR SETUP] menu → [DATE AND TIME].

To set the date and time automatically, refer to “Setting the date and time automatically” (➔ page 125).

- 1) Press ▲▼ to select an item.

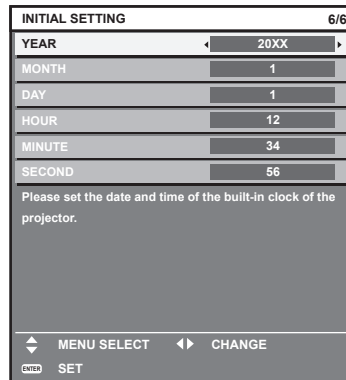

- 2) Press ◀▶ to switch the setting.
- 3) Press the <ENTER> button.
  - Confirm the setting value and complete the initial setting.

### Making adjustments and selections

It is recommended that images be projected continuously for at least 30 minutes before the focus is adjusted.

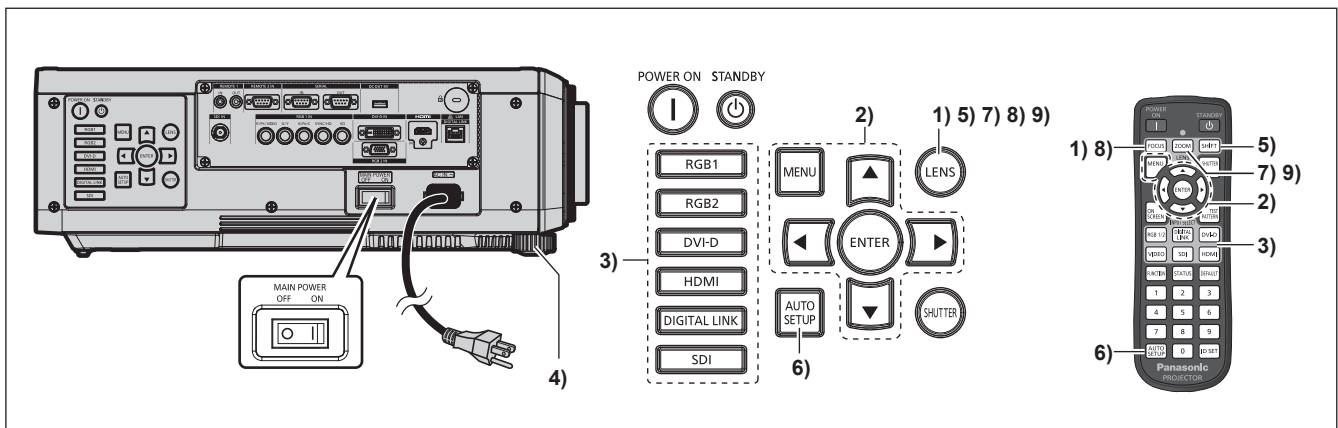

- 1) Press the <FOCUS> button to roughly adjust the focus of the image. (➔ page 62)
- 2) Change the setting of the [PROJECTOR SETUP] menu → [PROJECTION METHOD] depending on the installation mode. (➔ page 31)
  - Refer to “Navigating through the menu” (➔ page 71) for the operation of the menu screen.
- 3) Press the input selection (<RGB1> and <RGB2>, or <RGB1/2>, <DIGITAL LINK>, <DVI-D>, <VIDEO>, <SDI>, <HDMI>) button to select the input signal. (SDI input is supported only for PT-DZ780.)
- 4) Adjust the front, back and sideways tilt of the projector with the adjustable feet. (➔ page 46)
- 5) Press the <SHIFT> button to adjust the position of the image.
- 6) If the input signal is an RGB signal, press the <AUTO SETUP> button.
- 7) Press the <ZOOM> button to adjust the size of the image to match the screen.
- 8) Press the <FOCUS> button again to adjust the focus.
- 9) Press the <ZOOM> button again to adjust the zoom and the size of the image to match the screen.

**Note**

- When the projector is switched on for the first time after purchase, as well as when [ALL USER DATA] is executed from the [PROJECTOR SETUP] menu → [INITIALIZE], the focus adjustment screen is displayed after projection starts, then the [INITIAL SETTING] screen is displayed. Refer to “When the initial setting screen is displayed” (➡ page 57) for details.

**Switching off the projector**

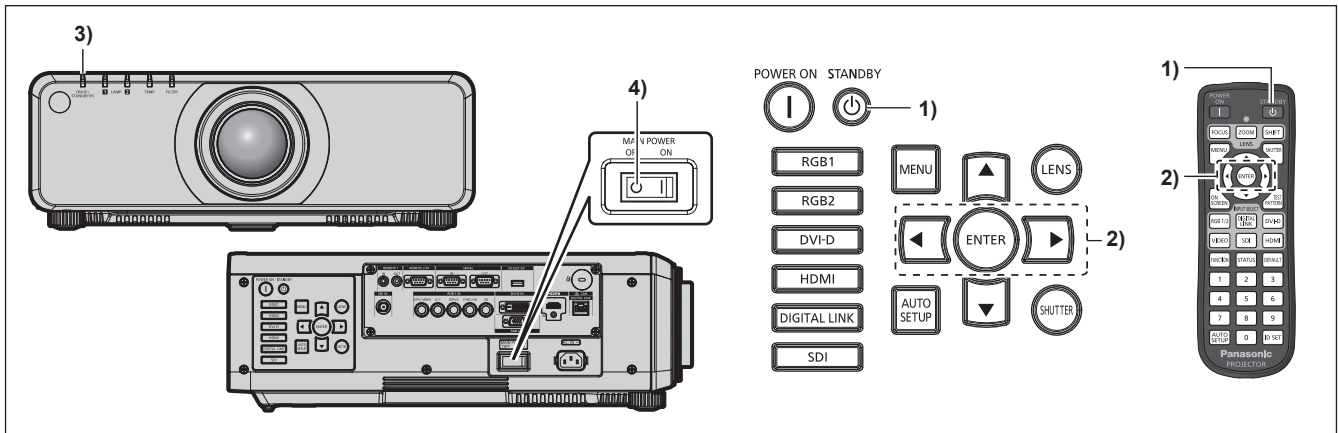

- 1) **Press the power standby <⏻> button.**
  - The [POWER OFF(STANDBY)] confirmation screen is displayed.
- 2) **Press ◀▶ to select [OK], and press the <ENTER> button.**  
(Or press the power standby <⏻> button again.)
  - Projection of the image will stop, and the power indicator <ON (G)/STANDBY (R)> on the projector body lights in orange. (The fan keeps running.)
- 3) **Wait until the power indicator <ON (G)/STANDBY (R)> on the projector body lights in red (and the fan stops) for 170 seconds.**
- 4) **Press the <OFF> side of the <MAIN POWER> switch to turn off the power.**

**Note**

- Do not switch on the projector and project images immediately after switching off the projector. Turning on the power while the lamp is still hot may shorten the life of the lamp.
- For about 75 seconds after the projector is switched off and the luminous lamp cooling is started, the indicator will not light up even if the power is switched on. Even after 75 seconds, the lamp may not light up if the projector is switched on. In such a case, switch on the projector again after the power indicator <ON (G)/STANDBY (R)> lights in red.
- **The projector consumes power even when the power standby <⏻> button is pressed and the projector is switched off if the main power of the projector is on.**  
When the [PROJECTOR SETUP] menu → [STANDBY MODE] is set to [ECO], use of some functions is restricted, but the power consumption during standby can be conserved.

**Direct power off function**

Even if the <MAIN POWER> switch is turned <OFF> during projection or immediately after turning off the luminous lamp, the fan runs using internally stored power to cool the luminous lamp. When the projector is mounted on the ceiling or installed in an environment where the <MAIN POWER> switch of the projector cannot be easily turned <OFF>, the power can be turned off directly using the circuit breaker. It is also safe in case a power outage occurs or the power cord is pulled out immediately after the projector is switched off.

**Note**

- If the [PROJECTOR SETUP] menu → [INITIAL STARTUP] is set to [LAST MEMORY] and the projector was turned off by using the circuit breaker directly while projecting during the last time of use, the power indicator <ON (G)/STANDBY (R)> will light in green a while after the circuit breaker is turned on, and then projection of the image will start.
- If cooled with the direct power off function, it may take longer than usual to be ready for projection when the projector is switched on the next time.
- Make sure that the fan is not running when packing the projector for transportation or storage.

# Projecting

Check the projection lens attachment (➔ page 47), external device connection (➔ page 49), power cord connection (➔ page 55), switch on the power (➔ page 56) to start projecting. Select the video for projection, and adjust appearance of the projected image.

## Selecting the input signal

Select an input signal.

- 1) Press the input selection (<RGB1> and <RGB2>, or <RGB1/2>, <DIGITAL LINK>, <DVI-D>, <VIDEO>, <SDI>, <HDMI>) button on the remote control or the control panel.

(SDI input is supported only for PT-DZ780.)

- The image of the signal being input in the selected terminal is projected.

### Attention

- Images may not be projected properly depending on the external device, or the Blu-ray disc or DVD disc, to be played back. Set the [PICTURE] menu → [SYSTEM SELECTOR].
- Confirm the aspect ratio of the projection screen and the image, and switch to an optimum aspect ratio from the [POSITION] menu → [ASPECT].

## Adjusting the focus, zoom, and shift

If the projected image or the position is not correct when the positioning of the projector and the screen is correctly installed, adjust the focus, zoom, and shift.

This section describes the adjustment method when anything other than the fixed-focus lens (Model No.: ET-DLE030) is used. When the fixed-focus lens (Model No.: ET-DLE030) is used, refer to “Adjusting the lens position and focus when the fixed-focus lens (Model No.: ET-DLE030) is used” (➔ page 63).

### Using the control panel

- 1) Press the <LENS> button on the control panel.
  - Pressing the button changes the adjustment screen in the order of [FOCUS], [ZOOM], and [SHIFT].
- 2) Select each item and press ▲▼◀▶ to adjust it.

### Using the remote control

- 1) Press the lens (<FOCUS>, <ZOOM>, <SHIFT>) buttons on the remote control.
  - <FOCUS> button: Adjusts focus.
  - <ZOOM> button: Adjusts zoom.
  - <SHIFT> button: Adjusts shift.
- 2) Select each item and press ▲▼◀▶ to adjust it.

## CAUTION

During the lens shift operation, do not insert your hand in any opening around the lens. Your hand may be caught in between, resulting in injury.

### Note

- When the projection lens without the zoom function is attached, the zoom adjustment screen will be displayed. However, operation is not possible.
- When the fixed-focus lens (Model No.: ET-DLE055) is used, do not use the shift adjustment, and use the projector with the lens position at the home position. (➔ page 63)
- Adjustments can be performed quickly by holding down ▲▼◀▶ for at least three seconds.
- It is recommended that images be projected continuously for at least 30 minutes before the focus is adjusted.
- Only [FOCUS] is shown in yellow so that the displayed menu item can be recognized by color, even when the projector is not focused and displayed characters are unreadable. (Factory default)  
The display color of [FOCUS] depends on the setting of the [DISPLAY OPTION] menu → [ON-SCREEN DISPLAY] → [OSD DESIGN].
- When the projector is switched off during the shift adjustment, lens calibration needs to be performed the next time the projector is switched on. (➔ page 125)

- When the main power is switched off during shift adjustment, a lens calibration error screen will be displayed during the next shift adjustment. Execute the [PROJECTOR SETUP] menu → [LENS CALIBRATION].
- When the lens calibration error is displayed even though [LENS CALIBRATION] was executed, ask your dealer to repair the unit.

## Adjusting the lens position and focus when the fixed-focus lens (Model No.: ET-DLE030) is used

After attaching the projection lens, adjust the lens position and the focus with the projector correctly installed against the screen.

The focus balance between the center and periphery of the projected image will differ depending on the size of the projected image when the fixed-focus lens (Model No.: ET-DLE030) is attached. Adjust the focus balance of the periphery with the fixed-focus lens (Model No.: ET-DLE030) as necessary.

### 1) Move the lens to the ET-DLE030 standard lens position.

- While the shift adjustment screen is displayed, press the <DEFAULT> button on the remote control to display the [HOME POSITION] screen. Select [DLE030] to move the lens to the standard lens position. Refer to “Setting the lens position” (➔ page 63) for details.

### 2) Adjust the focus at the center of projected image.

- For the steps to adjust the focus, refer to “Adjusting the focus, zoom, and shift” (➔ page 62).

### 3) Turn the periphery focus adjustment ring by hand to adjust the focus in the periphery of the screen.

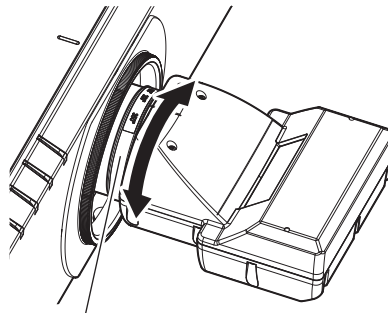

Periphery focus adjustment ring

### 4) Check the focus at the center of the image again and make fine adjustments.

#### Note

- The projected image size and scale shown on the periphery focus adjustment ring are an approximate guide.

## Setting the lens position

To move the lens position to the home position or the standard lens position, perform the following procedure.

### 1) Press the <DEFAULT> button on the remote control while the shift adjustment screen is displayed.

- The [HOME POSITION] screen is displayed.

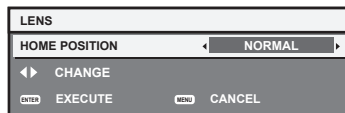

### 2) Press ◀▶ to switch the item.

- The items will switch each time you press the button.

[NORMAL]	Moves the lens to the home position. Select this item when replacing or removing the projection lens. Select this item when the fixed-focus lens (Model No.: ET-DLE055) is used for projection.
[DLE030]	Moves the lens to the ET-DLE030 standard lens position. Select this item when the fixed-focus lens (Model No.: ET-DLE030) is used for projection.

### 3) Press the <ENTER> button.

- [PROGRESS] is displayed in the [HOME POSITION] screen, and the lens position returns to the home position or the standard lens position.

**Note**

- Complete the operation within approximately 5 seconds after the [HOME POSITION] screen is displayed. The [HOME POSITION] screen will disappear after time limit.
- The home position of the lens is the lens position when the lens is being replaced or when the projector is being stored, and it is not the optical center of the screen.
- You can also display the [HOME POSITION] screen by pressing the <LENS> button on the control panel or the <SHIFT> button on the remote control for at least three seconds.

**Adjustment range by the lens position shift (optical shift)**

Perform the lens position shift within the adjustment range.

The focus may change when the lens position is shifted out of the adjustment range. This is because the movement of the lens is restricted to protect the optical parts. Projection position can be adjusted with the optical axis shift function based on the position of the projected screen in the home position (standard projection position).

Lens type	Zoom lens	
	Standard zoom lens, ET-DLE150, ET-DLE250, ET-DLE350, ET-DLE450	ET-DLE080, ET-DLE085
PT-DZ780	<p>Standard projection position</p> <p>Projected image height V</p> <p>Projected image width H</p>	<p>Standard projection position</p> <p>Projected image height V</p> <p>Projected image width H</p>
PT-DW750	<p>Standard projection position</p> <p>Projected image height V</p> <p>Projected image width H</p>	<p>Standard projection position</p> <p>Projected image height V</p> <p>Projected image width H</p>
PT-DX820	<p>Standard projection position</p> <p>Projected image height V</p> <p>Projected image width H</p>	<p>Standard projection position</p> <p>Projected image height V</p> <p>Projected image width H</p>

**Note**

- When the optional fixed-focus lens (Model No.: ET-DLE055) is attached, do not use the shift adjustment, and use the projector with the lens position at the home position.



- When the optional fixed-focus lens (Model No.: ET-DLE030) is attached, it can be used with the shift adjustment based on the projected image position in the standard lens position within the range that the edge of the projected image is not blocked by the projector body.

# Operating with the remote control

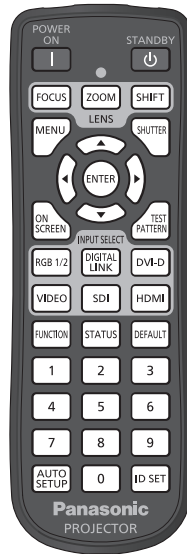

## Using the shutter function

If the projector is not used for a certain period of time during the meeting intermission, for example, it is possible to turn off the image temporarily.



**button**

**1) Press the <SHUTTER> button.**

- The image disappears.
- This operation can be also performed using the <SHUTTER> button on the control panel.

**2) Press the <SHUTTER> button again.**

- The image is displayed.

### Note

- The power indicator <ON (G)/STANDBY (R)> will blink slowly in green while the shutter function is in use (shutter: closed).

## Using the on-screen display function

Turn off the on-screen display function (no display) when you do not wish the viewers to see the on-screen display, such as the menu or the input terminal name.



**button**

**1) Press the <ON SCREEN> button.**

- The on-screen display disappears.

**2) Press the <ON SCREEN> button again.**

- The on-screen display appears.

### Note

- If you press the <MENU> button on the control panel for at least three seconds while the on-screen display is off (hidden), the on-screen display is turned on.

## Switching the input

The input for projection can be switched.

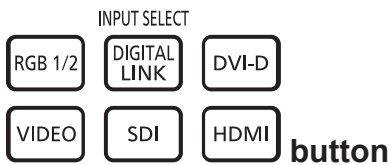

1) Press the input selection (<RGB1/2>, <DIGITAL LINK>, <DVI-D>, <VIDEO>, <SDI>, <HDMI>) button.

- This operation can be also performed using the buttons on the control panel.

<RGB1/2>	Switches the input to RGB1 or RGB2. Switches to the other input when one input has already been chosen.
<DIGITAL LINK>	Switches the input to DIGITAL LINK.
<DVI-D>	Switches the input to DVI-D.
<VIDEO>*1	Switches the input to RGB1.
<SDI>*2	Switches the input to SDI.
<HDMI>	Switches the input to HDMI.

\*1 The operation is disabled in the factory default settings. The operation is enabled when [REMOTE CONTROL] is set to [USER] and [VIDEO BUTTON] of [INPUT SELECT BUTTON] is set to other than [DISABLE], from the [SECURITY] menu → [CONTROL DEVICE SETUP].

\*2 SDI input is supported only for PT-DZ780.

### Note

- When the optional DIGITAL LINK output supported device (Model No.: ET-YFB100G, ET-YFB200G) is connected to the <DIGITAL LINK/ LAN> terminal, the input on the DIGITAL LINK output supported device changes each time the <DIGITAL LINK> button is pressed. The input can also be changed using the RS-232C control command.  
For twisted-pair-cable transmitters of other manufacturers, switch the input on the projector to DIGITAL LINK, and then switch the input on the twisted-pair-cable transmitter.

## Using the Status function

You can display the status of the projector.



1) Press the <STATUS> button.

- The [STATUS] screen is displayed.

STATUS		1/5
PROJECTOR TYPE	DZ780(123456789012)	
PROJECTOR RUNTIME	88h	
LAMP1	70h/ ON/	
LAMP2	70h/ ON/	
MAIN/SUB VERSION	1.00 / 1.00	
INTAKE AIR TEMP.	26°C/78°F	
OPTICS MODULE TEMP.	32°C/89°F	
EXHAUST AIR TEMP.	42°C/107°F	
COOLING CONDITION	AUTO - FLOOR	
ATMOSPHERIC PRESSURE	1013hPa	
SELF TEST	NO ERRORS	
ENTER SEND E-MAIL ◀ CHANGE MENU EXIT		

### Note

- This can be displayed from the [PROJECTOR SETUP] menu → [STATUS] (➔ page 122).

## Using the Automatic setup function

The automatic setup function can be used to automatically adjust the resolution, clock phase, and image position when analog RGB signals consisting of bitmap images such as computer signals are being input, or to automatically adjust the image position when DVI-D/HDMI signals are input. Supplying images with bright white borders at the edges and high-contrast black and white characters is recommended when the system is in automatic adjustment mode.

Avoid supplying images that include halftones or gradation, such as photographs and computer graphics.



**button**

### 1) Press the <AUTO SETUP> button.

- [COMPLETE] is displayed when it has completed without any problem.
- This operation can be also performed using the <AUTO SETUP> button on the control panel.

### Note

- The clock phase may shift even if it has completed without any incident. In such cases, adjust the [POSITION] menu → [CLOCK PHASE] (➔ page 85).
- If an image with blurred edges or a dark image is input, [INCOMPLETE] may appear or adjustment may not be performed properly even when [COMPLETE] appears. In this case, adjust the settings in the [ADVANCED MENU] menu → [INPUT RESOLUTION] (➔ page 89), [POSITION] → [CLOCK PHASE] (➔ page 85), and [SHIFT] (➔ page 83).
- Adjust special signals according to the [DISPLAY OPTION] menu → [AUTO SETUP] (➔ page 96).
- Automatic adjustment may not work depending on the model of the computer.
- Automatic adjustment may not work for a synchronization signal of C-SY or SYNC ON GREEN.
- Images may be disrupted for a few seconds during automatic adjustment, but it is not a malfunction.
- Adjustment is required for each input signal.
- Automatic adjustment can be canceled by pressing the <MENU> button during the automatic adjustment operation.
- If the automatic setup function is used while moving images are being input, the adjustment may not be performed properly even for an RGB signal that can use automatic setup. [INCOMPLETE] may appear, or adjustment may not be finished properly even if [COMPLETE] appears.

## Using the Function button

The [P IN P], [SUB MEMORY], [SYSTEM SELECTOR], [SYSTEM DAYLIGHT VIEW], [FREEZE], [WAVEFORM MONITOR], or [ASPECT] function can be assigned to the <FUNCTION> button on the remote control so that it can be used as an easy shortcut button.



**button**

### 1) Press the <FUNCTION> button.

### Note

- Assignment of the function is performed from the [PROJECTOR SETUP] menu → [FUNCTION BUTTON] (➔ page 124).

## Displaying internal test patterns

The projector has eight types of internal test patterns to check the condition of the projector. To display test patterns, perform the following steps.



**button**

### 1) Press the <TEST PATTERN> button.

### 2) Press ◀▶ to select the test pattern.

### Note

- Setting is also available from the [TEST PATTERN] (➔ page 130) menu.
- Settings of position, size, and other factors will not be reflected in test patterns. Make sure to display the input signal before performing various adjustments.

## Setting the remote control ID numbers

---

When you use the multiple projectors together, you can operate all the projectors simultaneously or each projector individually using single remote control, if a unique ID number is assigned to each projector.

After setting the ID number of the projector, set same ID number on the remote control.

**The factory default ID number of the projector is set to [ALL]. When using a single projector, keep pressing the <ID SET> button on the remote control for at least three seconds to set the ID number of the remote control to [ALL]. In addition, when the ID number of the projector is unknown, setting the ID number to [ALL] enables the remote control.**



button

- 1) Press the <ID SET> button on the remote control.
- 2) Within five seconds, press and set the one-digit or two-digit ID number set on the projector using the number (<0> - <9>) buttons.
  - When the ID number is set to [ALL], you can control the projector regardless of the ID number setting of the projector.

---

### Attention

---

- Since the ID number of the remote control can be set without the projector, do not press the <ID SET> button on the remote control carelessly. If the <ID SET> button is pressed and no number (<0> - <9>) buttons are pressed within five seconds, the ID number returns to its original value before the <ID SET> button was pressed.
- The ID number set on the remote control will be stored unless it is set again. However, it will be erased if the remote control is left with dead batteries. Set the same ID number again when the batteries are replaced.

---

### Note

---

- When the ID number of the remote control is set to [0], you can control the projector regardless of the ID number setting of the projector, as same as when [ALL] is set.
- Set the ID number of the projector from the [PROJECTOR SETUP] menu → [PROJECTOR ID].

# Chapter 4 Settings

---

This chapter describes the settings and adjustments you can make using the on-screen menu.

# Menu navigation

The on-screen menu (Menu) is used to perform various settings and adjustments of the projector.

## Navigating through the menu

### Operating procedure



button

- 1) Press the <MENU> button on the remote control or control panel.
  - The [MAIN MENU] screen is displayed.

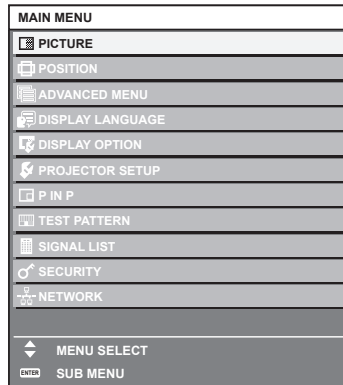

- 2) Press ▲▼ to select an item from the main menu.
  - The selected item is highlighted in yellow.

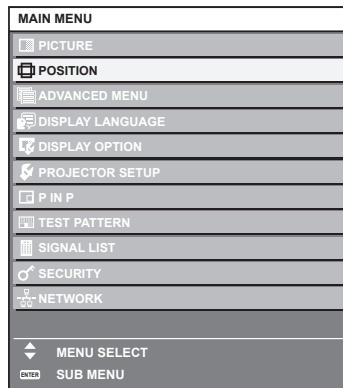

- 3) Press the <ENTER> button.
  - The sub-menu items of the selected main menu are displayed.

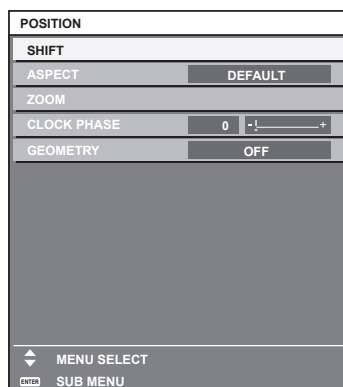

4) Press ▲▼ to select a sub-menu, and press ◀▶ or the <ENTER> button to change or adjust settings.

- Some items will switch in order as follows each time you press ◀▶.

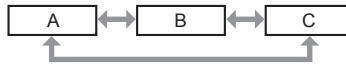

- For some items, press ◀▶ to display an individual adjustment screen with a bar scale as shown below.



### Note

- Pressing the <MENU> button while the menu screen is displayed returns to the previous menu.
- Depending on the signals to be input to the projector, some items or functions may not be adjusted or used. If items or functions cannot be adjusted or used, the items on the menu screen are shown in black characters, and they cannot be selected. [DIGITAL CINEMA REALITY] may not be displayed depending on the input signals.
- Some items can be adjusted even if signals are not input.
- Individual adjustment screen is cleared automatically if no operation is performed for approximately five seconds.
- For menu items, refer to "Main menu" (➔ page 72) and "Sub-menu" (➔ page 73).
- The cursor color depends on the settings of the [DISPLAY OPTION] menu → [ON-SCREEN DISPLAY] → [OSD DESIGN]. The selected item is displayed with the yellow cursor by the factory default.

### Resetting adjustment values to the factory default

If the <DEFAULT> button on the remote control is pressed, the values adjusted in the menu items are restored to the factory default settings.



1) Press the <DEFAULT> button on the remote control.



### Note

- You cannot reset all the settings to the factory default at a time.
- To reset all the settings adjusted in the sub-menu item to the factory default one at a time, execute the [PROJECTOR SETUP] menu → [INITIALIZE] (➔ page 126).
- Some items cannot be reset to the factory default settings even when the <DEFAULT> button on the remote control is pressed. Adjust those items individually.
- The triangular mark under the bar scale in the individual adjustment screen indicates the factory default setting. The position of the triangular mark varies according to the selected input signals.

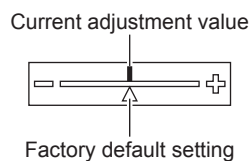







### Main menu

The following items are in the main menu.

When a main menu item is selected, the screen changes to a sub-menu selection screen.

Main menu item		Page
	[PICTURE]	76
	[POSITION]	83
	[ADVANCED MENU]	88
	[DISPLAY LANGUAGE]	93
	[DISPLAY OPTION]	94



Main menu item		Page
	[PROJECTOR SETUP]	111
	[P IN P]	128
	[TEST PATTERN]	130
	[SIGNAL LIST]	131
	[SECURITY]	134
	[NETWORK]	138

## Sub-menu

The sub-menu of the selected main menu item is displayed, and you can set and adjust items in the sub-menu.

### [PICTURE]

Sub-menu item	Factory default	Page
[PICTURE MODE]	[STANDARD]*1	76
[CONTRAST]	[0]	76
[BRIGHTNESS]	[0]	76
[COLOR]	[0]	77
[TINT]	[0]	77
[COLOR TEMPERATURE]	[DEFAULT]	77
[WHITE GAIN]	[+10]	79
[GAMMA]	[DEFAULT]	79
[SYSTEM DAYLIGHT VIEW]	[OFF]	80
[SHARPNESS]	[+6]	80
[NOISE REDUCTION]	[OFF]	80
[AI]	[ON]	81
[SYSTEM SELECTOR]	[Y P <sub>B</sub> P <sub>R</sub> ]*1	81

\*1 Depends on the signal input.

### Note

- The factory default settings may vary depending on the picture mode.

### [POSITION]

Sub-menu item	Factory default	Page
[SHIFT]	—	83
[ASPECT]	[DEFAULT]*1	83
[ZOOM]	—	84
[CLOCK PHASE]	[0]*1	85
[GEOMETRY]	[OFF]	85

\*1 Depends on the signal input.

### [ADVANCED MENU]

Sub-menu item	Factory default	Page
[DIGITAL CINEMA REALITY]	[AUTO]*1	88
[BLANKING]	—	88
[INPUT RESOLUTION]	—	89
[CLAMP POSITION]	[24]*1	89
[EDGE BLENDING]	[OFF]	90

Sub-menu item	Factory default	Page
[FRAME RESPONSE]	[NORMAL]	91
[RASTER POSITION]	—	92

\*1 Depends on the signal input.

**Note**

- Sub-menu items and factory default settings vary depending on the selected input terminal.

**[DISPLAY LANGUAGE]** 

Details (➔ page 93)

**[DISPLAY OPTION]** 

Sub-menu item	Factory default	Page
[COLOR MATCHING]	[OFF]	94
[COLOR CORRECTION]	[OFF]	95
[SCREEN SETTING]	—	95
[AUTO SIGNAL]	[OFF]	96
[AUTO SETUP]	—	96
[BACKUP INPUT SETTING]	—	97
[RGB IN]	—	98
[DVI-D IN]	—	99
[HDMI IN]	—	101
[DIGITAL LINK IN]	—	102
[SDI IN] <sup>*1</sup>	—	103
[ON-SCREEN DISPLAY]	—	104
[CLOSED CAPTION SETTING]	—	106
[BACK COLOR]	[BLUE]	106
[STARTUP LOGO]	[DEFAULT LOGO]	107
[UNIFORMITY]	—	107
[SHUTTER SETTING]	—	108
[FREEZE]	—	108
[WAVEFORM MONITOR]	[OFF]	108
[CUT OFF]	—	110

\*1 Only for PT-DZ780

**[PROJECTOR SETUP]** 

Sub-menu item	Factory default	Page
[PROJECTOR ID]	[ALL]	111
[PROJECTION METHOD]	[FRONT/FLOOR]	111
[COOLING CONDITION]	[AUTO]	112
[LAMP SELECT]	[DUAL]	112
[LAMP RELAY]	[OFF]	113
[LAMP POWER]	[NORMAL]	113
[BRIGHTNESS CONTROL]	—	114
[STANDBY MODE]	[NORMAL]	118
[SCHEDULE]	[OFF]	119
[INITIAL STARTUP]	[LAST MEMORY]	120
[STARTUP INPUT SELECT]	[LAST USED]	120
[RS-232C]	—	121
[STATUS]	—	122
[NO SIGNAL SHUT-OFF]	[DISABLE]	124
[REMOTE2 MODE]	[DEFAULT]	124
[FUNCTION BUTTON]	—	124

Sub-menu item	Factory default	Page
[DATE AND TIME]	—	124
[LENS CALIBRATION]	[NORMAL]	125
[SAVE ALL USER DATA]	—	126
[LOAD ALL USER DATA]	—	126
[INITIALIZE]	—	126
[SERVICE PASSWORD]	—	127

**[P IN P]** 

Details (➔ page 128)

**[TEST PATTERN]** 

Details (➔ page 130)

**[SIGNAL LIST]** 

Details (➔ page 131)

**[SECURITY]** 

Sub-menu item	Factory default	Page
[SECURITY PASSWORD]	[OFF]	134
[SECURITY PASSWORD CHANGE]	—	134
[DISPLAY SETTING]	[OFF]	134
[TEXT CHANGE]	—	135
[CONTROL DEVICE SETUP]	—	135
[CONTROL DEVICE PASSWORD CHANGE]	—	136

**[NETWORK]** 

Sub-menu item	Factory default	Page
[DIGITAL LINK MODE]	[AUTO]	138
[DIGITAL LINK SETUP]	—	138
[DIGITAL LINK STATUS]	—	139
[NETWORK SETUP]	—	139
[NETWORK CONTROL]	—	140
[NETWORK STATUS]	—	140
[DIGITAL LINK MENU]	—	141
[Art-Net SETUP]	[OFF]	141

**Note**

- Some items may not be adjusted or used for certain signal formats to be input to the projector.  
The menu items that cannot be adjusted or used are shown in black characters, and they cannot be selected.
- Sub-menu items and factory default settings vary depending on the selected input terminal.

## [PICTURE] menu

On the menu screen, select [PICTURE] from the main menu, and select an item from the sub-menu. Refer to “Navigating through the menu” (➔ page 71) for the operation of the menu screen.

- After selecting the item, press ▲▼◀▶ to adjust.

### [PICTURE MODE]

You can switch to the desired picture mode suitable for the image source and the environment in which the projector is used.

- 1) Press ▲▼ to select [PICTURE MODE].
- 2) Press ◀▶ or the <ENTER> button.
  - The [PICTURE MODE] individual adjustment screen is displayed.
- 3) Press ◀▶ to switch the item.
  - The items will switch each time you press the button.

[STANDARD]	The image becomes suitable for moving images in general.
[CINEMA]	The image becomes suitable for movie contents.
[NATURAL]	The image becomes sRGB compliant.
[REC709]*1	The image becomes Rec.709 compliant.
[DICOM SIM.]	The image becomes similar to that of DICOM Part14 gray scale standard.
[DYNAMIC]	The image becomes suitable for use in bright areas.
[GRAPHIC]	The image becomes suitable for input from the personal computer.

\*1 Use the factory default settings other than for [PICTURE MODE].

#### Note

- The factory default picture mode is [GRAPHIC] for still image input signals and [STANDARD] for movie-based input signals.
- Rec.709 is an abbreviation of “ITU-R Recommendation BT.709” and is a color standard of high-vision broadcasting.
- DICOM is an abbreviation of “Digital Imaging and COmmunication in Medicine” and is a standard for medical imaging devices. Although the DICOM name is used, the projector is not a medical device, and should not be used for purposes such as diagnosis of display images.

### [CONTRAST]

You can adjust the contrast of the colors.

- 1) Press ▲▼ to select [CONTRAST].
- 2) Press ◀▶ or the <ENTER> button.
  - The [CONTRAST] individual adjustment screen is displayed.
- 3) Press ◀▶ to adjust the level.

Operation	Adjustment	Range of adjustment
Press ▶.	The screen becomes brighter.	-31 - +31
Press ◀.	The screen becomes darker.	

#### Attention

- Adjust [BRIGHTNESS] first when you need to adjust the black level.

### [BRIGHTNESS]

You can adjust the dark (black) part of the projected image.

- 1) Press ▲▼ to select [BRIGHTNESS].
- 2) Press ◀▶ or the <ENTER> button.
  - The [BRIGHTNESS] individual adjustment screen is displayed.
- 3) Press ◀▶ to adjust the level.

Operation	Adjustment	Range of adjustment
Press ►.	Increases the brightness of the dark (black) parts of the screen.	-31 - +31
Press ◀.	Reduces the brightness of the dark (black) parts of the screen.	

## [COLOR]

You can adjust the color saturation of the projected image.

- 1) Press ▲▼ to select [COLOR].
- 2) Press ◀▶ or the <ENTER> button.
  - The [COLOR] individual adjustment screen is displayed.
- 3) Press ◀▶ to adjust the level.

Operation	Adjustment	Range of adjustment
Press ►.	Deepens colors.	-31 - +31
Press ◀.	Weakens colors.	

## [TINT]

You can adjust the skin tone in the projected image.

- 1) Press ▲▼ to select [TINT].
- 2) Press ◀▶ or the <ENTER> button.
  - The [TINT] individual adjustment screen is displayed.
- 3) Press ◀▶ to adjust the level.

Operation	Adjustment	Range of adjustment
Press ►.	Adjusts skin tone toward greenish color.	-31 - +31
Press ◀.	Adjusts skin tone toward reddish purple.	

## [COLOR TEMPERATURE]

You can switch the color temperature if the white areas of the projected image are bluish or reddish.

### Adjusting with color temperature

- 1) Press ▲▼ to select [COLOR TEMPERATURE].
- 2) Press ◀▶ or the <ENTER> button.
  - The [COLOR TEMPERATURE] individual adjustment screen is displayed.
- 3) Press ◀▶ to switch the item.
  - The items will switch each time you press the button.

[DEFAULT]	Factory default setting.
[USER1]	Adjusts white balance as desired. Refer to “Adjusting desired white balance” (➡ page 77) for details.
[USER2]	
[3200K] - [9300K]	Allows you to set in increments of 100 K. Select so that images become natural.

### Note

- When [PICTURE MODE] (➡ page 76) is set to [DICOM SIM.], [DEFAULT] cannot be selected.
- When [COLOR MATCHING] (➡ page 94) adjustment is set to other than [OFF], [COLOR TEMPERATURE] is fixed to [USER1].
- The color temperature numerical values are guidelines.

### Adjusting desired white balance

- 1) Press ▲▼ to select [COLOR TEMPERATURE].

- 2) Press ◀▶ or the <ENTER> button.
  - The [COLOR TEMPERATURE] individual adjustment screen is displayed.
- 3) Press ◀▶ to select [USER1] or [USER2].
- 4) Press the <ENTER> button.
  - The [COLOR TEMPERATURE] screen is displayed.
- 5) Press ▲▼ to select [WHITE BALANCE].
- 6) Press the <ENTER> button.
  - The [WHITE BALANCE] screen is displayed.
- 7) Press ▲▼ to select [WHITE BALANCE HIGH] or [WHITE BALANCE LOW].
- 8) Press the <ENTER> button.
  - The [WHITE BALANCE HIGH] screen or the [WHITE BALANCE LOW] screen is displayed.
- 9) Press ▲▼ to select [RED], [GREEN], or [BLUE].
- 10) Press ◀▶ to adjust the level.

Item	Operation	Adjustment	Range of adjustment
[RED]	Press ▶.	Deepens red.	[WHITE BALANCE HIGH]: 0 - +255 (factory default is +255) [WHITE BALANCE LOW]: -127 - +127 (factory default is 0)
	Press ◀.	Weakens red.	
[GREEN]	Press ▶.	Deepens green.	
	Press ◀.	Weakens green.	
[BLUE]	Press ▶.	Deepens blue.	
	Press ◀.	Weakens blue.	

#### Note

- Adjust [COLOR TEMPERATURE] correctly. All colors will not be displayed properly unless adequate adjustment is made. If the adjustment does not look suitable, you can press the <DEFAULT> button on the remote control to return the setting for the selected item only to the factory default setting.

#### Adjusting desired white balance based on existing color temperature settings

- 1) Press ▲▼ to select [COLOR TEMPERATURE].
- 2) Press ◀▶ or the <ENTER> button.
  - The [COLOR TEMPERATURE] individual adjustment screen is displayed.
- 3) Press ◀▶ to select an item other than [DEFAULT], [USER1], and [USER2].
- 4) Press the <ENTER> button.
  - The [CHANGE TO \*\*\*\*\*] screen is displayed.
- 5) Press ▲▼ to select [USER1] or [USER2].
  - The status of the color temperature changed is saved to the selected item.
- 6) Press the <ENTER> button.
  - The confirmation screen is displayed.
- 7) Press ◀▶ to select [OK], and press the <ENTER> button.
  - The [USER1] or [USER2] data is overwritten.
  - If you press ◀▶ to select [CANCEL] and then press the <ENTER> button, the data will not be overwritten.
  - The [WHITE BALANCE HIGH] screen is displayed.
- 8) Press ▲▼ to select [RED], [GREEN], or [BLUE].
- 9) Press ◀▶ to adjust the level.

**Note**

- Adjust [COLOR TEMPERATURE] correctly. All colors will not be displayed properly unless adequate adjustment is made. If the adjustment does not look suitable, you can press the <DEFAULT> button on the remote control to return the setting for the selected item only to the factory default setting.
- When color temperature has been changed, the colors before and after the change will differ slightly.

**Changing the name of [USER1] or [USER2]**

- 1) Press ▲▼ to select [COLOR TEMPERATURE].
- 2) Press ◀▶ or the <ENTER> button.
  - The [COLOR TEMPERATURE] individual adjustment screen is displayed.
- 3) Press ◀▶ to select [USER1] or [USER2].
- 4) Press the <ENTER> button.
  - The [COLOR TEMPERATURE] screen is displayed.
- 5) Press ▲▼ to select [COLOR TEMPERATURE NAME CHANGE].
- 6) Press the <ENTER> button.
  - The [COLOR TEMPERATURE NAME CHANGE] screen is displayed.
- 7) Press ▲▼◀▶ to select the text, and press the <ENTER> button to enter the text.
- 8) Press ▲▼◀▶ to select [OK], and press the <ENTER> button.
  - The name set to color temperature is changed.

**Note**

- When a name is changed, display of [USER1], [USER2] is also changed.

**[WHITE GAIN]**

Adjust the brightness of the white part of the image.

- 1) Press ▲▼ to select [WHITE GAIN].
- 2) Press ◀▶ or the <ENTER> button.
  - The [WHITE GAIN] individual adjustment screen is displayed.
- 3) Press ◀▶ to adjust the level.

Operation	Adjustment	Range of adjustment
Press ▶.	Brightness of the white part gets stronger.	0 - +10
Press ◀.	The image becomes more natural.	

**[GAMMA]**

You can switch gamma mode.

- 1) Press ▲▼ to select [GAMMA].
- 2) Press ◀▶ or the <ENTER> button.
  - The [GAMMA] individual adjustment screen is displayed.
- 3) Press ◀▶ to switch the item.
  - The items will switch each time you press the button.

[DEFAULT]	Factory default setting.
[1.8]	Set an item so that images become as you like.
[2.0]	
[2.2]	

**Note**

- When the edge blending adjustment is performed while [DEFAULT] is selected, it will be the same gamma mode as when [2.2] is selected. (Only for PT-DW750 and PT-DX820)

**[SYSTEM DAYLIGHT VIEW]**

You can correct the image to the optimal vividness even if it is projected under a bright light.

- 1) Press ▲▼ to select [SYSTEM DAYLIGHT VIEW].
- 2) Press ◀▶ or the <ENTER> button.
  - The [SYSTEM DAYLIGHT VIEW] individual adjustment screen is displayed.
- 3) Press ◀▶ to switch the item.
  - The items will switch each time you press the button.

[OFF]	No correction.
[1]	Corrects the image to weaken vividness.
[2]	Corrects the image to medium vividness.
[3]	Corrects the image to high vividness.

**[SHARPNESS]**

You can adjust the sharpness of the projected image.

- 1) Press ▲▼ to select [SHARPNESS].
- 2) Press ◀▶ or the <ENTER> button.
  - The [SHARPNESS] individual adjustment screen is displayed.
- 3) Press ◀▶ to adjust the level.

Operation	Adjustment	Range of adjustment
Press ▶.	Contours become sharper.	0 - +15
Press ◀.	Contours become softer.	

**Note**

- If you press ▶ while the adjustment value is [+15], the value will become [0]. If you press ◀ while the adjustment value is [0], the value will become [+15].

**[NOISE REDUCTION]**

You can reduce noises when the input image is degraded and noise is occurring in the image signal.

- 1) Press ▲▼ to select [NOISE REDUCTION].
- 2) Press ◀▶ or the <ENTER> button.
  - The [NOISE REDUCTION] individual adjustment screen is displayed.
- 3) Press ◀▶ to switch the item.
  - The items will switch each time you press the button.

[OFF]	No correction.
[1]	Slightly corrects the noise.
[2]	Moderately corrects the noise.
[3]	Strongly corrects the noise.

**Attention**

- When this is set for an input signal with less noise, the image may look different from what it originally was. In such a case, set it to [OFF].



## [AI]

Enable/disable the AI correction function (automatic gradation control). When it is enabled, gradation control is performed in accordance with the projected image, making the image optimal with contrast.

- 1) Press ▲▼ to select [AI].
- 2) Press ◀▶ or the <ENTER> button.
  - The [AI] individual adjustment screen is displayed.
- 3) Press ◀▶ to switch the item.
  - The items will switch each time you press the button.

[ON]	Enables the AI correction function.
[OFF]	Disables the AI correction function.

## [SYSTEM SELECTOR]

The projector will automatically detect the input signal, but you can set the system method manually when an unstable signal is input. Set the system method matching the input signal.

- 1) Press ▲▼ to select [SYSTEM SELECTOR].
- 2) Press the <ENTER> button.
- 3) Press ▲▼ to select a system format.
  - If signals are input via the <SDI IN> terminal, press ▲▼◀▶ to select the system format. (Only for PT-DZ780)
  - Available system formats vary depending on the input signal.

Terminal	System format	
<R/P <sub>R</sub> /VIDEO> terminal, <G/Y>/<B/P <sub>B</sub> /C> terminals	Select [AUTO], [NTSC], [NTSC4.43], [PAL], [PAL-M], [PAL-N], [SECAM], or [PAL60]. Set it to [AUTO] normally. (Setting [AUTO] will automatically select [NTSC], [NTSC4.43], [PAL], [PAL-M], [PAL-N], [SECAM], or [PAL60].) Switch the setting to the signal method for the TV used.	
<RGB 1 IN> terminal, <RGB 2 IN> terminal	480i, 576i, or 576p signal	Select [RGB] or [Y <sub>C<sub>B</sub>C<sub>R</sub></sub> ].
	VGA60 or 480p signal	Select [VGA60], [480p Y <sub>C<sub>B</sub>C<sub>R</sub></sub> ], or [480p RGB].
	Other movie-based signals	Select [RGB] or [Y <sub>P<sub>B</sub>P<sub>R</sub></sub> ].
<DVI-D IN> terminal	480i, 576i, 480p, or 576p signal	Select [RGB] or [Y <sub>C<sub>B</sub>C<sub>R</sub></sub> ].
	Other movie-based signals	Select [RGB] or [Y <sub>P<sub>B</sub>P<sub>R</sub></sub> ].
<HDMI IN> terminal, <DIGITAL LINK/LAN> terminal	480i, 576i, 480p, or 576p signal	Select [AUTO], [RGB], or [Y <sub>C<sub>B</sub>C<sub>R</sub></sub> ].
	Other movie-based signals	Select [AUTO], [RGB], or [Y <sub>P<sub>B</sub>P<sub>R</sub></sub> ].
<SDI IN> terminal (Only for PT-DZ780)	Select [AUTO], [480i Y <sub>C<sub>B</sub>C<sub>R</sub></sub> ], [576i Y <sub>C<sub>B</sub>C<sub>R</sub></sub> ], [720/50p Y <sub>P<sub>B</sub>P<sub>R</sub></sub> ], [720/60p Y <sub>P<sub>B</sub>P<sub>R</sub></sub> ], [1035/60i Y <sub>P<sub>B</sub>P<sub>R</sub></sub> ], [1080/24p Y <sub>P<sub>B</sub>P<sub>R</sub></sub> ], [1080/24sF Y <sub>P<sub>B</sub>P<sub>R</sub></sub> ], [1080/25p Y <sub>P<sub>B</sub>P<sub>R</sub></sub> ], [1080/30p Y <sub>P<sub>B</sub>P<sub>R</sub></sub> ], [1080/50i Y <sub>P<sub>B</sub>P<sub>R</sub></sub> ], [1080/60i Y <sub>P<sub>B</sub>P<sub>R</sub></sub> ], [1080/50p Y <sub>P<sub>B</sub>P<sub>R</sub></sub> ], [1080/60p Y <sub>P<sub>B</sub>P<sub>R</sub></sub> ], [1080/24p RGB], [1080/24sF RGB], [1080/25p RGB], [1080/30p RGB], [1080/50i RGB], or [1080/60i RGB].	

- 4) Press the <ENTER> button.

### Note

- Refer to “List of compatible signals” (➔ page 186) for the types of video signals that can be used with the projector.
- This may not function properly for some connected external devices.

## sRGB-compliant video

sRGB is an international standard (IEC61966-2-1) for color reproduction defined by IEC (International Electrotechnical Commission).

Set according to the following steps to reproduce more faithful, sRGB compliant colors.

- 1) Set [COLOR MATCHING] to [OFF].
  - Refer to [COLOR MATCHING] (➔ page 94).

- 2) **Display the [PICTURE] menu.**
  - Refer to “[PICTURE] menu” (➔ page 76).
- 3) **Press ▲▼ to select [PICTURE MODE].**
- 4) **Press ◀▶ to set [NATURAL].**
- 5) **Press ▲▼ to select [COLOR].**
- 6) **Press the <DEFAULT> button on the remote control to set the factory default setting.**
- 7) **Follow Steps 5) - 6) to set [TINT], [COLOR TEMPERATURE], [WHITE GAIN], [GAMMA], and [SYSTEM DAYLIGHT VIEW] to the factory default settings.**

---

**Note**

---

- sRGB is available for RGB signal input only.

## [POSITION] menu

On the menu screen, select [POSITION] from the main menu, and select an item from the sub-menu. Refer to “Navigating through the menu” (➔ page 71) for the operation of the menu screen.

- After selecting the item, press ▲▼◀▶ to adjust.

### Note

- When the optional DIGITAL LINK output supported device (Model No.: ET-YFB100G, ET-YFB200G) is connected to the <DIGITAL LINK/LAN> terminal, adjust the shift, aspect, and clock phase from the menu of DIGITAL LINK output supported device at the beginning.

## [SHIFT]

Move the image position vertically or horizontally if the image projected on the screen is still out of position even when the positions of the projector and screen are correct.

- 1) Press ▲▼ to select [SHIFT].
- 2) Press the <ENTER> button.
  - The [SHIFT] screen is displayed.
- 3) Press ▲▼◀▶ to adjust the position.

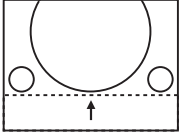
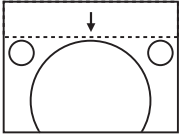
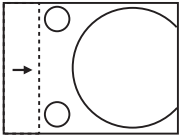
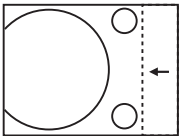
Orientation	Operation	Adjustment	
Vertical (up and down) adjustment	Press ▲.	The image position moves up.	
	Press ▼.	The image position moves down.	
Horizontal (right and left) adjustment	Press ▶.	The image position moves to the right.	
	Press ◀.	The image position moves to the left.	

## [ASPECT]

You can switch the aspect ratio of the image.

The aspect ratio is switched within the screen range selected in [SCREEN SETTING]. Set [SCREEN SETTING] first. (➔ page 95)

- 1) Press ▲▼ to select [ASPECT].
- 2) Press ◀▶ or the <ENTER> button.
  - The [ASPECT] individual adjustment screen is displayed.
- 3) Press ◀▶ to switch the item.
  - The items will switch each time you press the button.

[DEFAULT]	Displays images without changing the aspect ratio of the input signals.
[AUTO]*1	The projector identifies the video ID (VID) embedded in the video signals and displays the image by automatically switching the screen sizes between 4:3 and 16:9. This function is effective for 480i/480p signals.

[VID AUTO] <sup>*2</sup>	The projector identifies the video ID (VID) embedded in the video signals and displays the image by automatically switching the screen sizes between 4:3 and 16:9. This function is effective for NTSC signals.
[THROUGH]	Displays images without changing the resolution of the input signals.
[16:9]	Displays images with the aspect ratio converted to 16:9 when standard signals are input <sup>*3</sup> . Display images without changing the aspect ratio when wide-screen signals are input <sup>*4</sup> .
[4:3]	Displays images without changing the aspect ratio when standard signals are input <sup>*3</sup> . Displays images without changing the aspect ratio so that the images will fit in the 4:3 screen when wide-screen signals are input <sup>*4</sup> .
[H FIT]	Displays images using the entire width of the screen. When signals have the aspect ratio vertically longer than the aspect ratio of the screen selected in [SCREEN FORMAT], the images are displayed with the top and bottom parts cut off.
[V FIT]	Displays images using the entire height of the screen range selected in [SCREEN FORMAT]. When signals have the aspect ratio horizontally longer than the aspect ratio of the screen selected in [SCREEN FORMAT], the images are displayed with the right and left parts cut off.
[HV FIT]	Displays images in the entire screen range selected in [SCREEN FORMAT]. When the aspect ratio of the input signals differs from that of the screen range, the images are displayed with the aspect ratio converted to that of the screen selected in [SCREEN FORMAT].

\*1 During RGB signal (480i, 480p) input

\*2 During video signals and Y/C signal (NTSC) input only

\*3 Standard signals are input signals with an aspect ratio of 4:3 or 5:4.

\*4 Wide-screen signals are input signals with an aspect ratio of 16:10, 16:9, 15:9 or 15:10.

### Note

- Some size modes are not available for certain types of input signals. [DEFAULT] cannot be selected for video signal, Y/C signal (NTSC), or RGB (480i, 480p) signal.
- If an aspect ratio which is different from the aspect ratio for the input signals is selected, the images will appear differently from the originals. Be careful of this when selecting the aspect ratio.
- If using the projector in places such as cafes or hotels to display programs for a commercial purpose or for public presentation, note that adjusting the aspect ratio or using the zoom function to change the screen images may be an infringement of the rights of the original copyright owner for that program under copyright protection laws. Take care when using a function of the projector such as the aspect ratio adjustment and zoom function.
- If conventional (normal) 4:3 images which are not wide-screen images are displayed on a wide screen, the edges of the images may not be visible or they may become distorted. Such images should be viewed as with an aspect ratio of 4:3 in the original format intended by the creator of the images.

### [ZOOM]

You can adjust the image size.

#### When [ASPECT] is set to other than [DEFAULT] and [THROUGH]

- 1) Press ▲▼ to select [ZOOM].
- 2) Press the <ENTER> button.
  - The [ZOOM] screen is displayed.
- 3) Press ▲▼ to select [INTERLOCKED].
- 4) Press ◀▶ to switch the item.

[OFF]	Sets the [VERTICAL] and [HORIZONTAL] zoom ratio.
[ON]	Uses [BOTH] to set zoom ratio. Image can be enlarged or reduced vertically and horizontally at the same magnification.

- 5) Press ▲▼ to select [VERTICAL] or [HORIZONTAL].
  - If [ON] is selected, select [BOTH].
- 6) Press ◀▶ to adjust.

### Note

- When [ASPECT] is set to [THROUGH], [ZOOM] cannot be adjusted.

#### When [ASPECT] is set to [DEFAULT]

- 1) Press ▲▼ to select [ZOOM].

- 2) Press the <ENTER> button.
  - The [ZOOM] screen is displayed.
- 3) Press ▲▼ to select [MODE].
- 4) Press ◀▶ to switch the item.

[INTERNAL]	Enlarges the size within the aspect range set with [SCREEN FORMAT].
[FULL]	Enlarges or reduces the size using the entire display area set with [SCREEN FORMAT].

- 5) Press ▲▼ to select [INTERLOCKED].
- 6) Press ◀▶ to switch the item.

[OFF]	Sets the [VERTICAL] and [HORIZONTAL] zoom ratio.
[ON]	Uses [BOTH] to set zoom ratio. Image can be enlarged or reduced vertically and horizontally at the same magnification.

- 7) Press ▲▼ to select [VERTICAL] or [HORIZONTAL].
  - If [ON] is selected, select [BOTH].
- 8) Press ◀▶ to adjust.

**Note**

- When [ASPECT] is not set to [DEFAULT], [MODE] is not displayed.

**[CLOCK PHASE]**

You can adjust to achieve an optimal image when there is a flickering image or smeared outlines.

- 1) Press ▲▼ to select [CLOCK PHASE].
- 2) Press ◀▶ or the <ENTER> button.
  - The [CLOCK PHASE] individual adjustment screen is displayed.
- 3) Press ◀▶ to adjust.
  - Adjustment value will change between [0] and [+31]. Adjust so that the amount of interference is at a minimum.

**Note**

- Some signals may not be adjusted.
- Optimal value may not be achieved if the output from the input computer is unstable.
- Optimal value may not be achieved when there is a shift in the total dot numbers.
- [CLOCK PHASE] can be adjusted only when a signal is input to the <RGB 1 IN> terminal or the <RGB 2 IN> terminal.
- [CLOCK PHASE] cannot be adjusted when a digital signal is input.
- If you press ▶ while the adjustment value is [+31], the value will become [0]. If you press ◀ while the adjustment value is [0], the value will become [+31].

**[GEOMETRY]**

You can correct various types of distortion in a projected image.

Unique image processing technology enables projection of a square image on a special screen shape.

- 1) Press ▲▼ to select [GEOMETRY].
- 2) Press ◀▶ to switch the item.
  - The items will switch each time you press the button.

[OFF]	Does not perform geometric adjustment.
[KEystone]	Adjusts any trapezoidal distortion in the projected image.
[CORNER CORRECTION]	Adjusts any distortion in the four corners of the projected image.
[CURVED]	Adjusts any curved distortion in the projected image.

[PC-1]*1	Performs geometric adjustment using the computer. The optional Upgrade Kit (Model No.: ET-UK20) is required.
[PC-2]*1	
[PC-3]*1	

\*1 Only for PT-DZ780.

Advanced skills are necessary to use a computer to control geometric adjustment. Consult your dealer. Up to three geometric adjustments performed using the computer can be saved.

### Setting [KEYSTONE] or [CURVED]

- 1) Press ▲▼ to select [GEOMETRY].
- 2) Press ◀▶ to select [KEYSTONE] or [CURVED].
- 3) Press the <ENTER> button.
  - The [GEOMETRY:KEYSTONE] or [GEOMETRY:CURVED] screen is displayed.
- 4) Press ▲▼ to select the item to adjust.
- 5) Press ◀▶ to adjust.

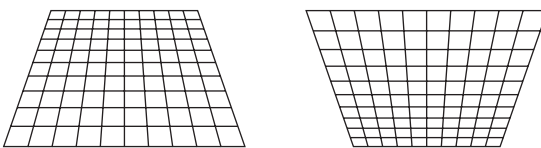
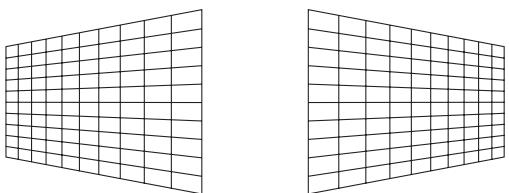
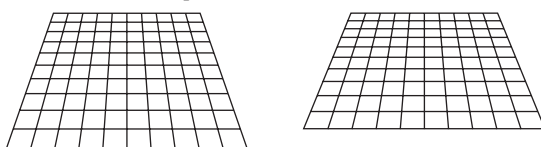
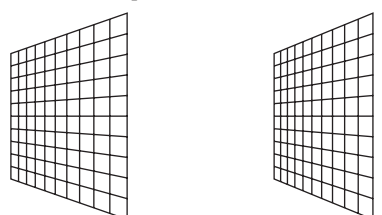
[KEYSTONE]			
<b>[LENS THROW RATIO]</b> Set the throw ratio for the lens used.			
<b>[VERTICAL KEYSTONE]</b> 	<b>[HORIZONTAL KEYSTONE]</b> 		
<b>[VERTICAL BALANCE]</b> 	<b>[HORIZONTAL BALANCE]</b> 		
Adjust the setting according to the lens shift range in the vertical direction.		Adjust the setting according to the lens shift range in the horizontal direction.	

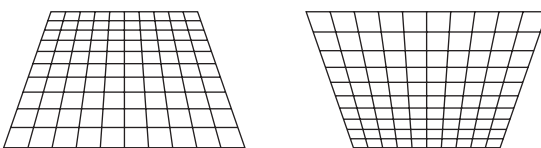
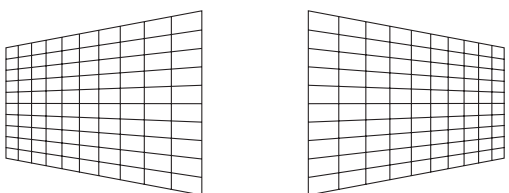
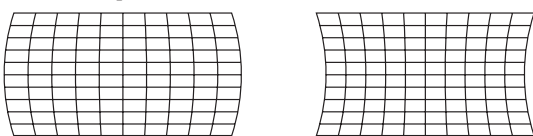
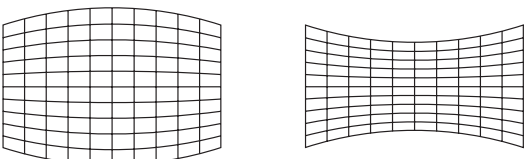
[CURVED]			
<b>[LENS THROW RATIO]</b> Set the throw ratio for the lens used.			
<b>[VERTICAL KEYSTONE]</b> 	<b>[HORIZONTAL KEYSTONE]</b> 		
<b>[VERTICAL ARC]</b> 	<b>[HORIZONTAL ARC]</b> 		

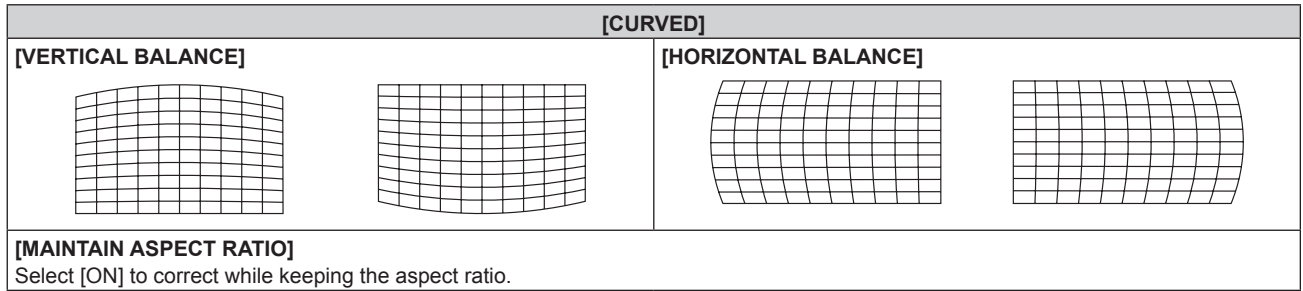

### Setting [CORNER CORRECTION]

- 1) Press ▲▼ to select [GEOMETRY].
- 2) Press ◀▶ to select [CORNER CORRECTION].
- 3) Press the <ENTER> button.
  - The [GEOMETRY:CORNER CORRECTION] screen is displayed.
- 4) Press ▲▼ to select the item to adjust, and press the <ENTER> button.
- 5) Press ▲▼◀▶ to adjust.

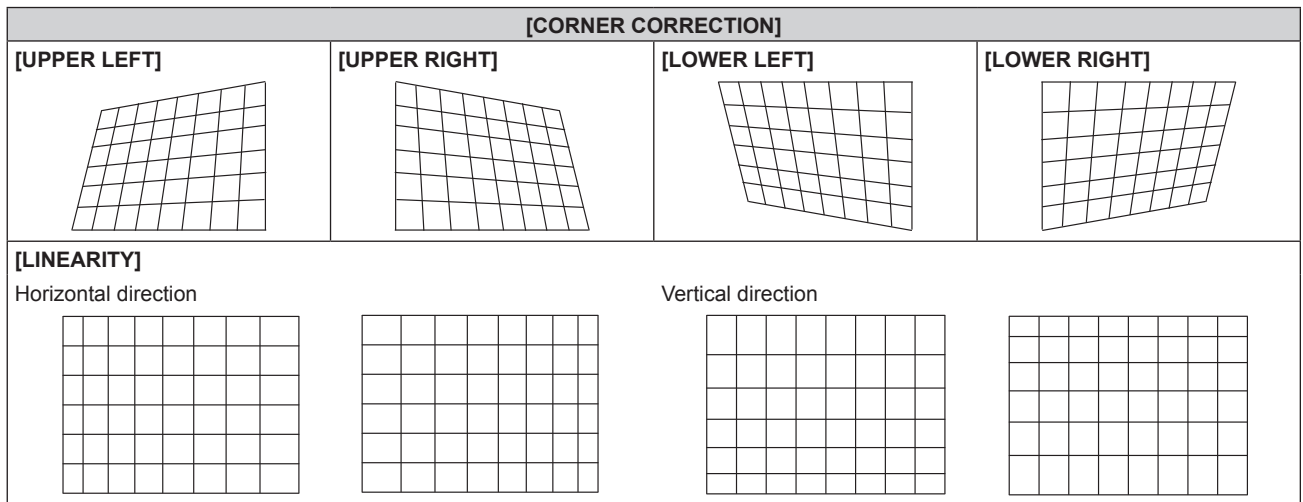

### Note

- The menu or logo may run off the screen when [GEOMETRY] is set.
- If [EDGE BLENDING] (▶ page 90) adjustment and [GEOMETRY] are used together, correct edge blending adjustment may not be possible in certain environments.
- The optional Upgrade Kit (Model No.: ET-UK20) can be used to expand the correctable range. To purchase the product, consult your dealer. (Only for PT-DZ780)
- The image may disappear for a moment while performing adjustment, but it is not a malfunction.

## [ADVANCED MENU] menu

On the menu screen, select [ADVANCED MENU] from the main menu, and select an item from the sub-menu.

Refer to “Navigating through the menu” (➔ page 71) for the operation of the menu screen.

- After selecting the item, press ▲▼◀▶ to adjust.

### [DIGITAL CINEMA REALITY]

You can increase the vertical resolution and enhance the image quality by performing cinema processing when the PAL (or SECAM) 576i signal, the NTSC 480i signal, and 1080/50i, 1080/60i are input.

1) Press ▲▼ to select [DIGITAL CINEMA REALITY].

2) Press ◀▶ to switch the item.

- The items will switch each time you press the button.

[AUTO]	Performs automatic detection and cinema processing. (Factory default)	
[OFF]	Does not perform cinema processing.	
[30p FIXED]	During 480i or 1080/60i signal input	Performs forced cinema processing (2:2 pull-down).
[25p FIXED]	During 576i or 1080/50i signal input	

#### Note

- In [DIGITAL CINEMA REALITY], the picture quality will degrade when a signal other than the 2:2 pull-down is set as [25p FIXED] or [30p FIXED]. (Vertical resolution will degrade.)
- When [FRAME RESPONSE] is set to [FAST], [DIGITAL CINEMA REALITY] cannot be set.

### [BLANKING]

You can adjust the blanking width if there are noises at the edge of the screen or the image is slightly running out from the screen while an image from the VCR or other devices are projected.

1) Press ▲▼ to select [BLANKING].

2) Press the <ENTER> button.

- The [BLANKING] adjustment screen is displayed.

3) Press ▲▼ to select [UPPER], [LOWER], [LEFT], or [RIGHT].

- When [CUSTOM MASKING] is set to an item other than [OFF] ([PC-1], [PC-2], or [PC-3]), the blanking width can be adjusted to any shape using the computer. Up to three blanking settings adjusted using the computer can be saved. (Only for PT-DZ780)

To use the [CUSTOM MASKING] function, the optional Upgrade Kit (Model No.: ET-UK20) is required. To purchase the product, consult your dealer.

4) Press ◀▶ to adjust the blanking width.

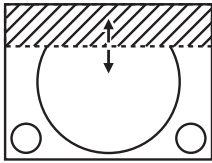
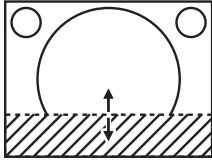
Blanking correction	Item	Operation	Adjustment	Range of adjustment	
Top of the screen	[UPPER]	Press ◀.	The blanking zone moves upward.		PT-DZ780: Top to bottom 0 - 599 PT-DW750: Top to bottom 0 - 399 PT-DX820: Top to bottom 0 - 383
		Press ▶.	The blanking zone moves downward.		
Bottom of the screen	[LOWER]	Press ▶.	The blanking zone moves upward.		
		Press ◀.	The blanking zone moves downward.		

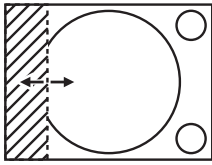
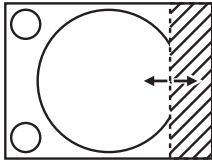

Blanking correction	Item	Operation	Adjustment	Range of adjustment	
Left side of the screen	[LEFT]	Press ▶.	The blanking zone moves to the right.		PT-DZ780: Left to right 0 - 959 PT-DW750: Left to right 0 - 639 PT-DX820: Left to right 0 - 511
		Press ◀.	The blanking zone moves to the left.		
Right side of the screen	[RIGHT]	Press ◀.	The blanking zone moves to the right.		
		Press ▶.	The blanking zone moves to the left.		

## [INPUT RESOLUTION]

You can adjust to achieve an optimal image when there is a flickering image or smeared outlines.

- 1) Press ▲▼ to select [INPUT RESOLUTION].
- 2) Press the <ENTER> button.
  - The [INPUT RESOLUTION] screen is displayed.
- 3) Press ▲▼ to select [TOTAL DOTS], [DISPLAY DOTS], [TOTAL LINES], or [DISPLAY LINES], and press ◀▶ to adjust each item.
  - Values corresponding to the signal being input are displayed automatically for each item. Increase or decrease the displayed values and adjust to the optimal point viewing the screen when there are vertical stripes or sections are missing from the screen.

### Note

- Previously mentioned vertical banding will not occur with all white signal input.
- The image may be disrupted while performing the adjustment, but it is not a malfunction.
- [INPUT RESOLUTION] can be adjusted only when an RGB signal is input to the <RGB 1 IN> terminal or the <RGB 2 IN> terminal.
- Some signals may not be adjusted.

## [CLAMP POSITION]

You can adjust the optimal point when the black part of the image is blunt or it has turned green.

- 1) Press ▲▼ to select [CLAMP POSITION].
- 2) Press ◀▶ to adjust.

Status	Rough guide for optimal value	Range of adjustment
The black part is blunt.	The point where bluntness of the black part improves the most is the optimal value.	1 - 255
The black part is green.	The point where the green part becomes black, and the bluntness has improved is the optimal value.	

### Note

- [CLAMP POSITION] can be adjusted only when a signal is input to the <RGB 1 IN> terminal or the <RGB 2 IN> terminal.
- Some signals may not be adjusted.

**[EDGE BLENDING]**

The edge blending function allows multiple projector images to be seamlessly overlapped by using the inclination of the brightness at the overlapped area.

- 1) Press ▲▼ to select [EDGE BLENDING].
- 2) Press ◀▶ to switch the item.
  - The items will switch each time you press the button.

[OFF]	Sets the edge blending function to off.
[ON]	Use the setting value preset in the projector for the inclination of the edge blending area.
[USER]	Use the user-setting value for the inclination of the edge blending area. (Configuration/registration requires separate software. Consult your dealer.)

- To adjust edge blending, proceed to Step 3).
- 3) When [ON] or [USER] is selected, press the <ENTER> button.
    - The [EDGE BLENDING] screen is displayed.
  - 4) Press ▲▼ to specify the location to be corrected.
    - When joining at top: Set [UPPER] to [ON]
    - When joining at bottom: Set [LOWER] to [ON]
    - When joining at left: Set [LEFT] to [ON]
    - When joining at right: Set [RIGHT] to [ON]
  - 5) Press ◀▶ to switch to [ON].
  - 6) Press ▲▼ to select [START] or [WIDTH].
  - 7) Press ◀▶ to adjust the starting position or correction width.
  - 8) Press ▲▼ to select [MARKER].
  - 9) Press ◀▶ to switch to [ON].
    - A marker for image position adjustment is displayed. The position where the red and green lines overlap for the projectors to be joined will be the optimal point. Make sure to set the correction width for the projectors to be joined with the same value. Optimal joining is not possible with projectors that have different correction widths.

The optimal point is the point at which these lines overlap.

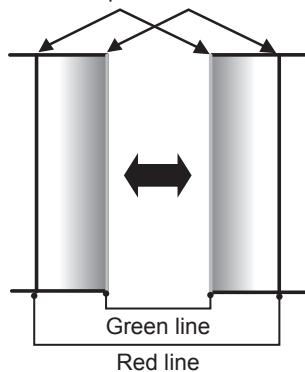

- 10) Press ▲▼ to select [BRIGHTNESS ADJUST].
- 11) Press the <ENTER> button.
  - The [BRIGHTNESS ADJUST] screen is displayed.
  - By setting [AUTO TESTPATTERN] to [ON] on the [EDGE BLENDING] screen, the black test pattern is displayed when you enter the [BRIGHTNESS ADJUST] screen.
- 12) Press ▲▼ to select [NON-OVERLAPPED BLACK LEVEL].
- 13) Press the <ENTER> button.
  - The [NON-OVERLAPPED BLACK LEVEL] screen is displayed.
  - If [INTERLOCKED] is set to [OFF], [RED], [GREEN], and [BLUE] can be adjusted individually.

- 14) Press ▲▼ to select an item, and press ◀▶ to adjust the setting.
  - Once the adjustment is completed, press the <MENU> button to return to the [BRIGHTNESS ADJUST] screen.
- 15) Press ▲▼ to select [UPPER], [LOWER], [LEFT], or [RIGHT] in [BLACK BORDER WIDTH].
- 16) Press ◀▶ to set the region (width) of the [BLACK BORDER WIDTH] adjustment.
- 17) Press ▲▼ to select [UPPER KEYSTONE AREA], [LOWER KEYSTONE AREA], [LEFT KEYSTONE AREA], or [RIGHT KEYSTONE AREA].
- 18) Press ◀▶ to adjust the tilt of the border between [NON-OVERLAPPED BLACK LEVEL] and [BLACK BORDER LEVEL].
- 19) Press ▲▼ to select [BLACK BORDER LEVEL].
- 20) Press the <ENTER> button.
  - The [BLACK BORDER LEVEL] screen is displayed.
  - If [INTERLOCKED] is set to [OFF], [RED], [GREEN], and [BLUE] can be adjusted individually.
- 21) Press ▲▼ to select an item, and press ◀▶ to adjust the setting.
  - Once the adjustment is completed, press the <MENU> button to return to the [BLACK BORDER LEVEL] screen.
- 22) Press ▲▼ to select [UPPER], [LOWER], [LEFT], or [RIGHT] in [OVERLAPPED BLACK LEVEL].
- 23) Press the <ENTER> button.
  - The [OVERLAPPED BLACK LEVEL] screen is displayed.
  - If [INTERLOCKED] is set to [OFF], [RED], [GREEN], and [BLUE] can be adjusted individually.
- 24) Press ▲▼ to select an item, and press ◀▶ to adjust the setting.

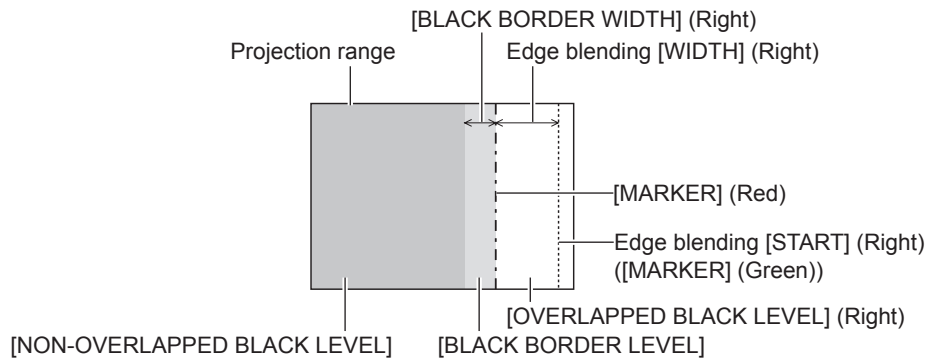

### Note

- [BRIGHTNESS ADJUST] is a function that makes the increased brightness in black level of the overlapping image area difficult to notice when [EDGE BLENDING] is used to configure multiple screens. The optimal amount of correction can be set by adjusting [NON-OVERLAPPED BLACK LEVEL] so that the black level of the overlapping image area will be the same as that of the non-overlapping area. If the border area between the image overlapping area and non-overlapping area gets brighter after adjusting [NON-OVERLAPPED BLACK LEVEL], adjust the width of the top, bottom, left, or right. Adjust [BLACK BORDER LEVEL] when the width adjustment makes only the border area darker.
- The joining part may look discontinuous depending on the position you are looking from when a screen with high gain or rear screen is used.
- When configuring multiple screens using both horizontal and vertical edge blending simultaneously, adjust [OVERLAPPED BLACK LEVEL] first before making adjustments in Step 12). Adjustment method is the same as the procedure of [NON-OVERLAPPED BLACK LEVEL].
- If only horizontal or only vertical edge blending is used, set all items in [OVERLAPPED BLACK LEVEL] to 0.
- The [AUTO TESTPATTERN] setting changes synchronizing with [AUTO TESTPATTERN] of [COLOR MATCHING].
- Adjustment of the tilt of the border between [NON-OVERLAPPED BLACK LEVEL] and [BLACK BORDER LEVEL] is a function to perform edge blending together with the adjustment of [GEOMETRY] (➔ page 85). If [NON-OVERLAPPED BLACK LEVEL] is tilted by correcting the keystone from [KEYSTONE] in [GEOMETRY], perform Steps 17) and 18) to adjust the edge blending according to the shape of [NON-OVERLAPPED BLACK LEVEL].

### [FRAME RESPONSE]

Set image frame delay.

- 1) Press ▲▼ to select [FRAME RESPONSE].

2) Press ◀▶ to switch the item.

- The items will switch each time you press the button.

<b>[NORMAL]</b>	Standard setting.
<b>[FAST]<sup>*1</sup></b>	Simplifies the image processing to reduce image frame delay.
<b>[FIXED]<sup>*2</sup></b>	Sets image frame delay to be constant regardless of the image position or magnification.

\*1 When input signals are other than interlaced signals, [FAST] cannot be set.

\*2 Only when movie-based signals and still image signals with the vertical scanning frequency of 50 Hz or 60 Hz are input

**Note**

- When [FRAME RESPONSE] is set to [FAST], picture quality deteriorates. Also, [DIGITAL CINEMA REALITY] cannot be set.
- [FRAME RESPONSE] cannot be set during P IN P.

**[RASTER POSITION]**

This will allow the position of the image to move within the display area arbitrarily when the input image is not using the whole display area.

1) Press ▲▼ to select [RASTER POSITION].

2) Press the <ENTER> button.

- The [RASTER POSITION] screen is displayed.

3) Press ▲▼◀▶ to adjust the position.

## [DISPLAY LANGUAGE] menu

On the menu screen, select [DISPLAY LANGUAGE] from the main menu, and display the sub-menu. Refer to “Navigating through the menu” (➔ page 71) for the operation of the menu screen.

- Press ▲▼ to select a language, and press the <ENTER> button to set.

### Changing the display language

You can select the language of the on-screen display.

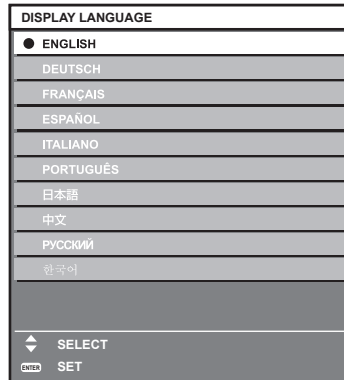

- Various menus, settings, adjustment screens, control button names, etc., are displayed in the selected language.
- The language can be changed to English, German, French, Spanish, Italian, Portuguese, Japanese, Chinese, Russian, or Korean.

### Note

- The on-screen display language of the projector is set to English by default as well as when [ALL USER DATA] (➔ page 126) in [INITIALIZE] is executed.

## [DISPLAY OPTION] menu

On the menu screen, select [DISPLAY OPTION] from the main menu, and select an item from the sub-menu.

Refer to “Navigating through the menu” (➔ page 71) for the operation of the menu screen.

- After selecting the item, press ▲▼◀▶ to set.

### [COLOR MATCHING]

Correct the color difference between projectors when using multiple projectors simultaneously.

#### Adjusting the color matching as desired

- 1) Press ▲▼ to select [COLOR MATCHING].
- 2) Press ◀▶ to switch the item.
  - The items will switch each time you press the button.

[OFF]	Color matching adjustment is not carried out.
[3COLORS]	Adjusts the three colors [RED], [GREEN], or [BLUE].
[7COLORS]	Adjusts the seven colors [RED], [GREEN], [BLUE], [CYAN], [MAGENTA], [YELLOW], or [WHITE].
[MEASURED]	Refer to “Adjusting the color matching using a colorimeter” (➔ page 95) for details about this mode.

- 3) Select [3COLORS] or [7COLORS], and press the <ENTER> button.
  - The [3COLORS] or [7COLORS] screen is displayed.
- 4) Press ▲▼ to select [RED], [GREEN], or [BLUE] ([RED], [GREEN], [BLUE], [CYAN], [MAGENTA], [YELLOW], or [WHITE] for [7COLORS]).
- 5) Press the <ENTER> button.
  - The [3COLORS:RED], [3COLORS:GREEN], or [3COLORS:BLUE] screen is displayed.  
For [7COLORS], the [7COLORS:RED], [7COLORS:GREEN], [7COLORS:BLUE], [7COLORS:CYAN], [7COLORS:MAGENTA], [7COLORS:YELLOW], or [7COLORS:WHITE] screen is displayed.
  - By setting [AUTO TESTPATTERN] to [ON], the test pattern for the selected color is displayed.
- 6) Press ▲▼ to select [RED], [GREEN], or [BLUE].
- 7) Press ◀▶ to adjust.
  - The adjustment value changes between 0\*1 and 2 048.

\*1 The lower limit varies depending on the color to be adjusted.

#### Note

- Operation when correcting the adjustment color  
When the correction color same as the adjustment color is changed: The luminance of the adjustment color changes.  
When correction color red is changed: Red is added to or subtracted from the adjustment color.  
When correction color green is changed: Green is added to or subtracted from the adjustment color.  
When correction color blue is changed: Blue is added to or subtracted from the adjustment color.
- Since advanced skills are necessary for the adjustment, this adjustment should be carried out by a person who is familiar with the projector or by a service person.
- Pressing the <DEFAULT> button on the remote control will restore the factory default settings for all items.
- If [COLOR MATCHING] is set to other than [OFF], [COLOR CORRECTION] is fixed to [OFF], and [COLOR TEMPERATURE] is fixed to [USER1].
- The [AUTO TESTPATTERN] setting changes synchronizing with [AUTO TESTPATTERN] of [EDGE BLENDING].

### Adjusting the color matching using a colorimeter

Use a colorimeter that can measure chromaticity coordinates and luminance to change the colors [RED], [GREEN], [BLUE], [CYAN], [MAGENTA], [YELLOW], or [WHITE] to desired colors.

- 1) Press ▲▼ to select [COLOR MATCHING].
- 2) Press ◀▶ to select [MEASURED].
- 3) Press the <ENTER> button.
  - The [MEASURED MODE] screen is displayed.
- 4) Press ▲▼ to select [MEASURED DATA].
- 5) Press the <ENTER> button.
  - The [MEASURED DATA] screen is displayed.
- 6) Measure the current luminance (Y) and the chromaticity coordinates (x, y) using the colorimeter.
- 7) Press ▲▼ to select a color, and press ◀▶ to adjust the setting.
  - By setting [AUTO TESTPATTERN] to [ON] on the [MEASURED MODE] screen, the test pattern for the selected color is displayed.
- 8) Once all the input is completed, press the <MENU> button.
  - The [MEASURED MODE] screen is displayed.
- 9) Press ▲▼ to select [TARGET DATA].
- 10) Press the <ENTER> button.
  - The [TARGET DATA] screen is displayed.
- 11) Press ▲▼ to select a color and press ◀▶ to input coordinates for desired colors.
  - By setting [AUTO TESTPATTERN] to [ON] on the [MEASURED MODE] screen, the test pattern for the selected color is displayed.
- 12) Once all the input is completed, press the <MENU> button.

#### Note

- Colors are not displayed properly when target data is a color outside the region of this projector.
- Set the [AUTO TESTPATTERN] to [ON] to automatically display a test pattern for use in adjusting the selected adjustment colors.
- The [AUTO TESTPATTERN] setting changes synchronizing with [AUTO TESTPATTERN] of [EDGE BLENDING].
- When using a colorimeter or similar instrument to take measurement, measure the colors displayed with [AUTO TESTPATTERN].
- A difference in the color coordinates of target data and measurement values obtained from an instrument may occur for certain instruments and measurement environments used.

### [COLOR CORRECTION]

Colors can be adjusted and registered for each input signal format.

- 1) Press ▲▼ to select [COLOR CORRECTION].
- 2) Press ◀▶ to switch the item.
  - The items will switch each time you press the button.

[OFF]	Standard setting
[USER]	For each of the following four signal formats, VIDEO, Y/C, RGB, and YC <sub>B</sub> C <sub>R</sub> /YP <sub>B</sub> P <sub>R</sub> , six colors of red, green, blue, cyan, magenta, and yellow can be adjusted and registered. Press the <ENTER> button to set the details. Adjustment is possible within the range of -31 to +31.

### [SCREEN SETTING]

Set the screen size.

Correct to the optimum image position for the set screen when the aspect ratio of a projected image is changed. Set as necessary for the screen in use.

- 1) Press ▲▼ to select [SCREEN SETTING].

- 2) Press the <ENTER> button.
  - The [SCREEN SETTING] screen is displayed.
- 3) Press ◀▶ to switch the [SCREEN FORMAT] item.
  - The items will switch each time you press the button.

Model No.	[SCREEN FORMAT]	Range when [SCREEN POSITION] is selected
PT-DZ780	[16:10]	Cannot be adjusted.
	[4:3]	Adjusts the horizontal position between -160 and 160.
	[16:9]	Adjusts the vertical position between -60 and 60.
PT-DW750	[16:10]	Cannot be adjusted.
	[16:9]	Adjusts the vertical position between -40 and 40.
PT-DX820	[4:3]	Cannot be adjusted.
	[16:9]	Adjusts the vertical position between -96 and 96.

- 4) Press ▲▼ to select [SCREEN POSITION].
  - If [SCREEN FORMAT] is set to [16:10] in PT-DZ780 and PT-DW750, or if [SCREEN FORMAT] is set to [4:3] in PT-DX820, [SCREEN POSITION] cannot be selected and adjusted.
- 5) Press ◀▶ to adjust [SCREEN POSITION].

## [AUTO SIGNAL]

Set whether to execute automatic setup of signals automatically.

The screen display position or signal level can be adjusted automatically without pressing the <AUTO SETUP> button on the remote control on each occasion if you input unregistered signals frequently at meetings, etc.

- 1) Press ▲▼ to select [AUTO SIGNAL].
- 2) Press ◀▶ to switch the item.
  - The items will switch each time you press the button.

[OFF]	Sets the auto signal function to off.
[ON]	Executes automatic setup automatically when images are changed to unregistered signals during projection.

## [AUTO SETUP]

Set this when adjusting a special signal or horizontally long (such as 16:9) signal.

### Setting with [MODE]

- 1) Press ▲▼ to select [AUTO SETUP].
- 2) Press the <ENTER> button.
  - The [AUTO SETUP] screen is displayed.
- 3) Press ▲▼ to select [MODE].
- 4) Press ◀▶ to switch the item.
  - The items will switch each time you press the button.

[DEFAULT]	Standard setting.
[WIDE]	Select this item when an image aspect ratio is a wide-screen signal, which does not meet the [DEFAULT] setting.
[USER]	Select this item when receiving a signal with a special horizontal resolution (number of display dots).

- When [DEFAULT] or [WIDE] is selected, proceed to Step 7).
- 5) Press ▲▼ to select [DISPLAY DOTS], and press ◀▶ to adjust [DISPLAY DOTS] to the horizontal resolution of the signal source.
  - 6) Press ▲▼ to select [MODE].



7) Press the <ENTER> button.

- Automatic adjustment is executed. [PROGRESS] is displayed while in automatic adjustment. When completed, the screen returns to the [AUTO SETUP] screen.

**Note**

- Automatic setup of signal can be executed when analog RGB signals consisting of dots such as computer signals or DVI-D/HDMI signals are being input.

**Adjusting position automatically**

- 1) Press ▲▼ to select [AUTO SETUP].
- 2) Press the <ENTER> button.
  - The [AUTO SETUP] screen is displayed.
- 3) Press ▲▼ to select [POSITION ADJUST].
- 4) Press ◀▶ to switch the item.

[ON]	Adjust the screen position and size when automatic setup is executed.
[OFF]	Does not perform automatic adjustment.

**Adjusting signal level automatically**

- 1) Press ▲▼ to select [AUTO SETUP].
- 2) Press the <ENTER> button.
  - The [AUTO SETUP] screen is displayed.
- 3) Press ▲▼ to select [SIGNAL LEVEL ADJUST].
- 4) Press ◀▶ to switch the item.

[OFF]	Does not perform automatic adjustment.
[ON]	Adjusts black level (on-screen menu [BRIGHTNESS]) and white level (on-screen menu [CONTRAST]) when automatic setup is executed.

**Note**

- [SIGNAL LEVEL ADJUST] may not function properly unless a still image containing clear blacks and whites is input.

**[BACKUP INPUT SETTING]**

Set the backup function to switch the signal to the backup input as seamless as possible when input signal is disrupted.

- 1) Press ▲▼ to select [BACKUP INPUT SETTING].
- 2) Press the <ENTER> button.
  - The [BACKUP INPUT SETTING] screen is displayed.
- 3) Press ▲▼ to select [BACKUP INPUT MODE].
- 4) Press ◀▶ to switch the item.
  - The items will switch each time you press the button.

[OFF]	Disables the backup function.
[ON]	Enables the backup function between the DVI-D input and the HDMI input. The input is switched as seamless as possible when the same signal is input to the primary and secondary inputs. Primary input is fixed to the <DVI-D IN> terminal, and the secondary input is fixed to the <HDMI IN> terminal.

- 5) Press ▲▼ to select [AUTOMATIC SWITCHING].
  - When [BACKUP INPUT MODE] is set to [OFF], [AUTOMATIC SWITCHING] cannot be selected.

6) Press ◀▶ to switch the item.

- The items will switch each time you press the button.

[ENABLE]	Switches to the secondary input automatically when the input signal for primary input is disrupted.
[DISABLE]	Disables the automatic input switching function.

**Note**

- Backup function is enabled only when the [BACKUP INPUT MODE] is [ON] and the same signal is input to the <DVI-D IN> terminal and <HDMI IN> terminal.
- To switch to the backup input signal using the backup function, make sure that the following three conditions are satisfied to be ready to use the function.
  - Set [BACKUP INPUT MODE] to [ON].
  - Input the same signal to the primary and secondary inputs.
  - Display the image of the primary input.
- If the input is switched to other than the primary or secondary input while the backup function is ready for use, the state of readiness to use the backup function is canceled. To switch to the backup input signal using the backup function again, switch to the primary input.
- When [BACKUP INPUT MODE] is [ON], [BACKUP INPUT STATUS] is displayed both in the input guide (▶ page 104) and on the [STATUS] screen (▶ pages 67, 122).  
When switching to the backup input signal is possible using the backup function, [ACTIVE] is displayed in [BACKUP INPUT STATUS]. When it is not possible, [INACTIVE] is displayed instead.  
When [BACKUP INPUT STATUS] is [ACTIVE] while the image of the primary input is displayed, the secondary input becomes the backup input.  
When [BACKUP INPUT STATUS] is [ACTIVE] while the image of the secondary input is displayed, the primary input becomes the backup input.
- If the inputs of DVI-D and HDMI are switched while [BACKUP INPUT MODE] is set to [ON] and switching to the backup input signal is possible, the input is switched seamlessly.
- When [AUTOMATIC SWITCHING] is set to [ENABLE] and [BACKUP INPUT STATUS] is [ACTIVE], the signal is switched to the backup input automatically if the input signal is disrupted.
- When [AUTOMATIC SWITCHING] is set to [ENABLE] and the signal is automatically switched to the backup input due to disruption of the input signal, [BACKUP INPUT STATUS] changes to [INACTIVE]. In this case, switching to the backup input signal is not possible until the original input signal is restored. If the signal is automatically switched to the backup input, switching to the backup input signal becomes possible when the original input signal is restored. In this case, the current input is retained.
- [BACKUP INPUT SETTING] cannot be set during P IN P. The backup operation is not performed either.

**[RGB IN]**

Set to match the signal to input to the <RGB 1 IN> terminal.

**Setting [RGB1 INPUT SETTING]**

- 1) Press ▲▼ to select [RGB IN].
- 2) Press the <ENTER> button.
  - The [RGB IN] screen is displayed.
- 3) Press ▲▼ to select [RGB1 INPUT SETTING].
- 4) Press ◀▶ to switch the item.
  - The items will switch each time you press the button.

[RGB/YP <sub>B</sub> P <sub>R</sub> ]	Select this item when an RGB signal or YC <sub>B</sub> C <sub>R</sub> /YP <sub>B</sub> P <sub>R</sub> signal is being input to the <RGB 1 IN> terminal.
[VIDEO]	Select this item when a video signal is being input to the <RGB 1 IN> (<R/P <sub>R</sub> /VIDEO>) terminal.
[Y/C]	Select this item when a luminance signal and color signal are being input to the <RGB 1 IN> (<G/Y>, <B/P <sub>B</sub> /C>) terminal.

**Note**

- When [REMOTE CONTROL] is set to [USER] and [VIDEO BUTTON] of [INPUT SELECT BUTTON] is set to other than [DISABLE] from the [SECURITY] menu → [CONTROL DEVICE SETUP] (▶ page 135), pressing the <VIDEO> button on the remote control switches [RGB1 INPUT SETTING] to [VIDEO] or [Y/C].

**Switching the slice level of an input sync signal**

- 1) Press ▲▼ to select [RGB IN].
- 2) Press the <ENTER> button.
  - The [RGB IN] screen is displayed.

- 3) Press ▲▼ to select [RGB1 SYNC SLICE LEVEL] or [RGB2 SYNC SLICE LEVEL].
- 4) Press ◀▶ to switch the item.

[LOW]	Sets the slice level to [LOW].
[HIGH]	Sets the slice level to [HIGH].

### Setting [RGB2 EDID MODE]

- 1) Press ▲▼ to select [RGB IN].
- 2) Press the <ENTER> button.
  - The [RGB IN] screen is displayed.
- 3) Press ▲▼ to select [RGB2 EDID MODE].
- 4) Press the <ENTER> button.
  - The [RGB2 EDID MODE] screen is displayed.
- 5) Press ◀▶ to switch [EDID MODE].
  - The items will switch each time you press the button.

[DEFAULT]	Standard setting.
[SCREEN FIT]	Changes EDID data according to the [SCREEN FORMAT] setting.
[USER]	Sets the [RESOLUTION] and [VERTICAL SCAN FREQUENCY] items to EDID.

- When [DEFAULT] or [SCREEN FIT] is selected, proceed to Step 10).
- 6) Press the <ENTER> button.
    - The [RESOLUTION] screen is displayed.
  - 7) Press ▲▼◀▶ to select [RESOLUTION].
    - Select [1024x768p], [1280x720p], [1280x768p], [1280x800p], [1280x1024p], [1366x768p], [1400x1050p], [1440x900p], [1600x900p], [1600x1200p], [1680x1050p], [1920x1080p], [1920x1080i], or [1920x1200p].
  - 8) Press the <ENTER> button.
    - The [VERTICAL SCAN FREQUENCY] screen is displayed.
  - 9) Press ◀▶ to select [VERTICAL SCAN FREQUENCY].
    - Select [60Hz], [50Hz], [30Hz], [25Hz], or [24Hz] when [1920x1080p] is selected for [RESOLUTION].
    - Select [60Hz], [50Hz], or [48Hz] when [1920x1080i] is selected for [RESOLUTION].
    - Select [60Hz] or [50Hz] when anything other than [1920x1080p] or [1920x1080i] is selected for [RESOLUTION].
  - 10) Press the <ENTER> button.
    - The confirmation screen is displayed.
  - 11) Press ◀▶ to select [OK], and press the <ENTER> button.

#### Note

- The setting details are displayed in [RESOLUTION] and [VERTICAL SCAN FREQUENCY] of [EDID STATUS].
- The resolution and vertical scanning frequency settings may be required on your computer or video device.
- After configuring settings, your computer or video device or the projector may be required to be restarted.
- Output with resolution and vertical scanning frequency that have been set may not be performed depending on your computer or video device.

### [DVI-D IN]

Switch the setting when the external device is connected to the <DVI-D IN> terminal of the projector and the image is not projected correctly.

- 1) Press ▲▼ to select [DVI-D IN].
- 2) Press the <ENTER> button.
  - The [DVI-D IN] screen is displayed.

- 3) Press ▲▼ to select [EDID SELECT].
- 4) Press ◀▶ to switch the item.
  - The items will switch each time you press the button.

[EDID3]	Recognizes movie-based video signals and still image signals automatically.
[EDID1]	Select this item mainly when an external device that outputs movie-based video signals (such as a Blu-ray disc player) is connected to the <DVI-D IN> terminal.
[EDID2:PC]	Select this item mainly when an external device that outputs still image-based video signals (such as a computer) is connected to the <DVI-D IN> terminal.

- 5) Press ▲▼ to select [SIGNAL LEVEL].
- 6) Press ◀▶ to switch the item.
  - The items will switch each time you press the button.

[AUTO]	Automatically sets the signal level.
[0-255:PC]	Select this item when the signal output from the DVI-D terminal of an external device (such as a computer) is input to the <DVI-D IN> terminal.
[16-235]	Select this item when the signal output from the HDMI terminal of an external device (such as a Blu-ray disc player) is input to the <DVI-D IN> terminal via a conversion cable or similar cable.

### Note

- The optimal setting varies depending on the output setting of the connected external device. Refer to the operating instructions of the external device regarding the output of the external device.
- The data for Plug and play will change when the setting is changed. Refer to “List of compatible signals” (➔ page 186) for a resolution that supports plug and play.

### Setting [EDID MODE]

- 1) Press ▲▼ to select [DVI-D IN].
- 2) Press the <ENTER> button.
  - The [DVI-D IN] screen is displayed.
- 3) Press ▲▼ to select [EDID MODE].
- 4) Press the <ENTER> button.
  - The [DVI-D EDID MODE] screen is displayed.
- 5) Press ◀▶ to switch [EDID MODE].
  - The items will switch each time you press the button.

[DEFAULT]	Standard setting.
[SCREEN FIT]	Changes EDID data according to the [SCREEN FORMAT] setting.
[USER]	Sets the [RESOLUTION] and [VERTICAL SCAN FREQUENCY] items to EDID.

- When [DEFAULT] or [SCREEN FIT] is selected, proceed to Step 10).
- 6) Press the <ENTER> button.
    - The [RESOLUTION] screen is displayed.
  - 7) Press ▲▼◀▶ to select [RESOLUTION].
    - Select [1024x768p], [1280x720p], [1280x768p], [1280x800p], [1280x1024p], [1366x768p], [1400x1050p], [1440x900p], [1600x900p], [1600x1200p], [1680x1050p], [1920x1080p], [1920x1080i], or [1920x1200p].
  - 8) Press the <ENTER> button.
    - The [VERTICAL SCAN FREQUENCY] screen is displayed.
  - 9) Press ◀▶ to select [VERTICAL SCAN FREQUENCY].
    - Select [60Hz], [50Hz], [30Hz], [25Hz], or [24Hz] when [1920x1080p] is selected for [RESOLUTION].
    - Select [60Hz], [50Hz], or [48Hz] when [1920x1080i] is selected for [RESOLUTION].
    - Select [60Hz] or [50Hz] when anything other than [1920x1080p] or [1920x1080i] is selected for [RESOLUTION].

10) Press the <ENTER> button.

- The confirmation screen is displayed.

11) Press ◀▶ to select [OK], and press the <ENTER> button.

**Note**

- The setting details are displayed in [RESOLUTION] and [VERTICAL SCAN FREQUENCY] of [EDID STATUS].
- The resolution and vertical scanning frequency settings may be required on your computer or video device.
- After configuring settings, your computer or video device or the projector may be required to be restarted.
- Output with resolution and vertical scanning frequency that have been set may not be performed depending on your computer or video device.

**[HDMI IN]**

Switch the setting when the external device is connected to the <HDMI IN> terminal of the projector and the image is not projected correctly.

1) Press ▲▼ to select [HDMI IN].

2) Press the <ENTER> button.

- The [HDMI IN] screen is displayed.

3) Press ▲▼ to select [SIGNAL LEVEL].

4) Press ◀▶ to switch the item.

- The items will switch each time you press the button.

[AUTO]	Automatically sets the signal level.
[64-940]	Select this item when the signal output from the HDMI terminal of an external device (such as a Blu-ray disc player) is input to the <HDMI IN> terminal.
[0-1023]	Select this item when the signal output from the DVI-D terminal of an external device (such as a computer) is input to the <HDMI IN> terminal via a conversion cable or similar cable. Select this item also when the signal output from the HDMI terminal of a computer or other device is input to the <HDMI IN> terminal.

**Note**

- The optimal setting varies depending on the output setting of the connected external device. Refer to the operating instructions of the external device regarding the output of the external device.
- The signal level is displayed for 30 bits of input.

**Setting [EDID MODE]**

1) Press ▲▼ to select [HDMI IN].

2) Press the <ENTER> button.

- The [HDMI IN] screen is displayed.

3) Press ▲▼ to select [EDID MODE].

4) Press the <ENTER> button.

- The [HDMI EDID MODE] screen is displayed.

5) Press ◀▶ to switch [EDID MODE].

- The items will switch each time you press the button.

[DEFAULT]	Standard setting.
[SCREEN FIT]	Changes EDID data according to the [SCREEN FORMAT] setting.
[USER]	Sets the [RESOLUTION] and [VERTICAL SCAN FREQUENCY] items to EDID.

- When [DEFAULT] or [SCREEN FIT] is selected, proceed to Step 10).

6) Press the <ENTER> button.

- The [RESOLUTION] screen is displayed.

7) Press ▲▼◀▶ to select [RESOLUTION].

- Select [1024x768p], [1280x720p], [1280x768p], [1280x800p], [1280x1024p], [1366x768p], [1400x1050p], [1440x900p], [1600x900p], [1600x1200p], [1680x1050p], [1920x1080p], [1920x1080i], or [1920x1200p].

8) Press the <ENTER> button.

- The [VERTICAL SCAN FREQUENCY] screen is displayed.

9) Press ◀▶ to select [VERTICAL SCAN FREQUENCY].

- Select [60Hz], [50Hz], [30Hz], [25Hz], or [24Hz] when [1920x1080p] is selected for [RESOLUTION].
- Select [60Hz], [50Hz], or [48Hz] when [1920x1080i] is selected for [RESOLUTION].
- Select [60Hz] or [50Hz] when anything other than [1920x1080p] or [1920x1080i] is selected for [RESOLUTION].

10) Press the <ENTER> button.

- The confirmation screen is displayed.

11) Press ◀▶ to select [OK], and press the <ENTER> button.

**Note**

- The setting details are displayed in [RESOLUTION] and [VERTICAL SCAN FREQUENCY] of [EDID STATUS].
- The resolution and vertical scanning frequency settings may be required on your computer or video device.
- After configuring settings, your computer or video device or the projector may be required to be restarted.
- Output with resolution and vertical scanning frequency that have been set may not be performed depending on your computer or video device.

**[DIGITAL LINK IN]**

Set the signal level when DIGITAL LINK input is selected.

1) Press ▲▼ to select [DIGITAL LINK IN].

2) Press the <ENTER> button.

- The [DIGITAL LINK IN] screen is displayed.

3) Press ▲▼ to select [SIGNAL LEVEL].

4) Press ◀▶ to switch the item.

- The items will switch each time you press the button.

[AUTO]	Automatically sets the signal level.
[64-940]	Select this item when the HDMI terminal output of an external device (such as a Blu-ray disc player) is input to the <DIGITAL LINK/LAN> terminal via a twisted-pair-cable transmitter.
[0-1023]	Select this item when the DVI-D terminal output or HDMI terminal output of an external device (such as a computer) is input to the <DIGITAL LINK/LAN> terminal via a twisted-pair-cable transmitter.

**Note**

- The optimal setting varies depending on the output setting of the connected external device. Refer to the operating instructions of the external device regarding the output of the external device.
- The signal level is displayed for 30 bits of input.

**Setting [EDID MODE]**

1) Press ▲▼ to select [DIGITAL LINK IN].

2) Press the <ENTER> button.

- The [DIGITAL LINK IN] screen is displayed.

3) Press ▲▼ to select [EDID MODE].

4) Press the <ENTER> button.

- The [DIGITAL LINK EDID MODE] screen is displayed.

5) Press ◀▶ to switch [EDID MODE].

- The items will switch each time you press the button.

[DEFAULT]	Standard setting.
-----------	-------------------

[SCREEN FIT]	Changes EDID data according to the [SCREEN FORMAT] setting.
[USER]	Sets the [RESOLUTION] and [VERTICAL SCAN FREQUENCY] items to EDID.

- When [DEFAULT] or [SCREEN FIT] is selected, proceed to Step 10).
- 6) Press the <ENTER> button.
    - The [RESOLUTION] screen is displayed.
  - 7) Press ▲▼◀▶ to select [RESOLUTION].
    - Select [1024x768p], [1280x720p], [1280x768p], [1280x800p], [1280x1024p], [1366x768p], [1400x1050p], [1440x900p], [1600x900p], [1600x1200p], [1680x1050p], [1920x1080p], [1920x1080i], or [1920x1200p].
  - 8) Press the <ENTER> button.
    - The [VERTICAL SCAN FREQUENCY] screen is displayed.
  - 9) Press ◀▶ to select [VERTICAL SCAN FREQUENCY].
    - Select [60Hz], [50Hz], [30Hz], [25Hz], or [24Hz] when [1920x1080p] is selected for [RESOLUTION].
    - Select [60Hz], [50Hz], or [48Hz] when [1920x1080i] is selected for [RESOLUTION].
    - Select [60Hz] or [50Hz] when anything other than [1920x1080p] or [1920x1080i] is selected for [RESOLUTION].
  - 10) Press the <ENTER> button.
    - The confirmation screen is displayed.
  - 11) Press ◀▶ to select [OK], and press the <ENTER> button.

**Note**

- The setting details are displayed in [RESOLUTION] and [VERTICAL SCAN FREQUENCY] of [EDID STATUS].
- The resolution and vertical scanning frequency settings may be required on your computer or video device.
- After configuring settings, your computer or video device or the projector may be required to be restarted.
- Output with resolution and vertical scanning frequency that have been set may not be performed depending on your computer or video device.

**[SDI IN]**

(Only for PT-DZ780)

Set this item according to the signal to be input to the <SDI IN> terminal.

**Setting [SIGNAL LEVEL]**

Select the amplitude of the signal to input.

- 1) Press ▲▼ to select [SDI IN].
- 2) Press the <ENTER> button.
  - The [SDI IN] screen is displayed.
- 3) Press ▲▼ to select [SIGNAL LEVEL].
- 4) Press ◀▶ to switch the item.

[64-940]	Normally use this setting.
[4-1019]	Select when gray is displayed as black.

**Setting [BIT DEPTH]**

- 1) Press ▲▼ to select [SDI IN].
- 2) Press the <ENTER> button.
  - The [SDI IN] screen is displayed.
- 3) Press ▲▼ to select [BIT DEPTH].
- 4) Press ◀▶ to switch the item.

[AUTO]	Automatically select [12-bit] or [10-bit].
--------	--

[12-bit]	Fixes to [12-bit].
[10-bit]	Fixes to [10-bit].

### Setting [3G-SDI MAPPING]

- 1) Press ▲▼ to select [SDI IN].
- 2) Press the <ENTER> button.
  - The [SDI IN] screen is displayed.
- 3) Press ▲▼ to select [3G-SDI MAPPING].
- 4) Press ◀▶ to switch the item.

[AUTO]	Automatically select [LEVEL A] or [LEVEL B].
[LEVEL A]	Fixes to [LEVEL A].
[LEVEL B]	Fixes to [LEVEL B].

#### Note

- It does not operate during SD-SDI or HD-SDI signal input.

### [ON-SCREEN DISPLAY]

Set the on-screen display.

#### Setting [OSD POSITION]

Set the position of the menu screen (OSD).

- 1) Press ▲▼ to select [ON-SCREEN DISPLAY].
- 2) Press the <ENTER> button.
  - The [ON-SCREEN DISPLAY] screen is displayed.
- 3) Press ▲▼ to select [OSD POSITION].
- 4) Press ◀▶ to switch the item.
  - The items will switch each time you press the button.

[2]	Sets to the center left of the screen.
[3]	Sets to the bottom left of the screen.
[4]	Sets to the top center of the screen.
[5]	Sets to the center of the screen.
[6]	Sets to the bottom center of the screen.
[7]	Sets to the upper right of the screen.
[8]	Sets to the center right of the screen.
[9]	Sets to the bottom right of the screen.
[1]	Sets to the upper left of the screen.

#### Setting [OSD DESIGN]

Set the color of the menu screen (OSD).

- 1) Press ▲▼ to select [ON-SCREEN DISPLAY].
- 2) Press the <ENTER> button.
  - The [ON-SCREEN DISPLAY] screen is displayed.
- 3) Press ▲▼ to select [OSD DESIGN].
- 4) Press ◀▶ to switch the item.
  - The items will switch each time you press the button.

[1]	Sets to yellow.
-----	-----------------



[2]	Sets to blue.
[3]	Sets to white.
[4]	Sets to green.
[5]	Sets to peach.
[6]	Sets to brown.

### Setting [OSD MEMORY]

Set hold for the position of the menu screen (OSD) cursor.

- 1) Press ▲▼ to select [ON-SCREEN DISPLAY].
- 2) Press the <ENTER> button.
  - The [ON-SCREEN DISPLAY] screen is displayed.
- 3) Press ▲▼ to select [OSD MEMORY].
- 4) Press ◀▶ to switch the item.
  - The items will switch each time you press the button.

[ON]	Holds the cursor position.
[OFF]	Does not hold the cursor position.

#### Note

- Even when [OSD MEMORY] is set to [ON], the cursor position will not be held when the <MAIN POWER> switch of the projector is set to <OFF>.

### Setting [INPUT GUIDE]

Set whether to display the input guide (input terminal name, signal name, and memory number currently selected) in the position set in the [OSD POSITION].

- 1) Press ▲▼ to select [ON-SCREEN DISPLAY].
- 2) Press the <ENTER> button.
  - The [ON-SCREEN DISPLAY] screen is displayed.
- 3) Press ▲▼ to select [INPUT GUIDE].
- 4) Press ◀▶ to switch the item.
  - The items will switch each time you press the button.

[ON]	Displays the input guide.
[OFF]	Hides the input guide.

### Setting [WARNING MESSAGE]

Set the display/hide of the warning message.

- 1) Press ▲▼ to select [ON-SCREEN DISPLAY].
- 2) Press the <ENTER> button.
  - The [ON-SCREEN DISPLAY] screen is displayed.
- 3) Press ▲▼ to select [WARNING MESSAGE].
- 4) Press ◀▶ to switch the item.
  - The items will switch each time you press the button.

[ON]	Displays the warning message.
[OFF]	Hides the warning message.

**[CLOSED CAPTION SETTING] (for NTSC or 480i YC<sub>B</sub>C<sub>R</sub> signal input only)**

Set closed captions.

**Selecting the closed caption display**

- 1) Press ▲▼ to select [CLOSED CAPTION SETTING].
- 2) Press the <ENTER> button.
  - The [CLOSED CAPTION SETTING] screen is displayed.
- 3) Press ▲▼ to select [CLOSED CAPTION].
- 4) Press ◀▶ to switch the item.
  - The items will switch each time you press the button.

[OFF]	Hides closed captions.
[ON]	Displays closed captions.

- When [ON] is selected, proceed to Step 5).

- 5) When the confirmation screen is displayed, press ◀▶ to select [OK], and press the <ENTER> button.

**Setting the closed caption mode**

- 1) Press ▲▼ to select [CLOSED CAPTION SETTING].
- 2) Press the <ENTER> button.
  - The [CLOSED CAPTION SETTING] screen is displayed.
- 3) Press ▲▼ to select [MODE].
  - When [CLOSED CAPTION] is set to [OFF], [MODE] cannot be selected.
- 4) Press ◀▶ to switch the item.
  - The items will switch each time you press the button.

[CC1]	Displays CC1 data.
[CC2]	Displays CC2 data.
[CC3]	Displays CC3 data.
[CC4]	Displays CC4 data.

**Note**

- Closed caption is a function that displays text information of video signals mainly used in North America. Captions may not be displayed depending on the connected devices or contents being played back.
- [CLOSED CAPTION SETTING] can be selected only if NTSC or 480i YC<sub>B</sub>C<sub>R</sub> signal is input.
- If [CLOSED CAPTION] is set to [ON], brightness of images may change depending on the external devices compatible with closed caption function to be connected or contents to be used.
- If a closed caption signal of the selected mode is input, the security message set in the [SECURITY] menu → [DISPLAY SETTING] (➔ page 134) is not displayed.
- Closed captions are not displayed when the menu screen is displayed.

**[BACK COLOR]**

Set the display of the projected screen when there is no signal input.

- 1) Press ▲▼ to select [BACK COLOR].
- 2) Press ◀▶ to switch the item.
  - The items will switch each time you press the button.

[BLUE]	Displays the entire projection area in blue.
[BLACK]	Displays the entire projection area in black.
[DEFAULT LOGO]	Displays the Panasonic logo.
[USER LOGO]	Displays the image registered by the user.

**Note**

- To create/register the [USER LOGO] image, use "Logo Transfer Software" included in the supplied CD-ROM.

**[STARTUP LOGO]**

Set the logo display when the power is turned on.

- 1) Press ▲▼ to select [STARTUP LOGO].
- 2) Press ◀▶ to switch the item.
  - The items will switch each time you press the button.

[DEFAULT LOGO]	Displays the Panasonic logo.
[USER LOGO]	Displays the image registered by the user.
[NONE]	Disables the startup logo display.

**Note**

- The startup logo will disappear in approximately 15 seconds.
- To create/register the [USER LOGO] image, use "Logo Transfer Software" included in the supplied CD-ROM.

**[UNIFORMITY]**

Correct the brightness and color unevenness of the entire screen.

**Adjusting by each color**

- 1) Press ▲▼ to select [UNIFORMITY].
- 2) Press the <ENTER> button.
  - The [UNIFORMITY] screen is displayed.
- 3) Press ▲▼ to select [VERTICAL] or [HORIZONTAL].
- 4) Press ◀▶ to adjust the level.

Item	Operation	Adjustment	Range of adjustment
[VERTICAL]	Press ▶.	The lower-side color becomes pale, or the upper-side color becomes dark.	-127 - 127
	Press ◀.	The upper-side color becomes pale, or the lower-side color becomes dark.	
[HORIZONTAL]	Press ▶.	The left-side color becomes pale, or the right-side color becomes dark.	
	Press ◀.	The right-side color becomes pale, or the left-side color becomes dark.	

**Setting [PC CORRECTION]**

To use the [PC CORRECTION] function, the optional Upgrade Kit (Model No.: ET-UK20) is required. To purchase the product, consult your dealer.

- 1) Press ▲▼ to select [UNIFORMITY].
- 2) Press the <ENTER> button.
  - The [UNIFORMITY] screen is displayed.
- 3) Press ▲▼ to select [PC CORRECTION].
- 4) Press ◀▶ to switch the item.

[OFF]	Does not perform correction using computer.
[ON]*1	Performs correction for the brightness and color unevenness of the entire screen using computer.

\*1 Advanced skills are necessary to use computer control correction. Consult your dealer.

**Note**

- [UNIFORMITY] can be set for each [LAMP SELECT] setting.
- The [UNIFORMITY] settings are not reset to the factory defaults even when [ALL USER DATA] is executed from the [PROJECTOR SETUP] menu → [INITIALIZE] (➔ page 126).

**[SHUTTER SETTING]**

The shutter function can be automatically enabled/disabled (shutter: closed/open) when the power is turned off/on.

**Setting [STARTUP]**

- 1) Press ▲▼ to select [SHUTTER SETTING].
- 2) Press the <ENTER> button.
  - The [SHUTTER SETTING] screen is displayed.
- 3) Press ▲▼ to select [STARTUP].
- 4) Press ◀▶ to switch the item.

[OPEN]	Starts projection with the shutter function disabled (shutter: open) when the power is turned on.
[CLOSE]	Starts projection with the shutter function enabled (shutter: closed) when the power is turned on.

**Setting [SHUT-OFF]**

- 1) Press ▲▼ to select [SHUTTER SETTING].
- 2) Press the <ENTER> button.
  - The [SHUTTER SETTING] screen is displayed.
- 3) Press ▲▼ to select [SHUT-OFF].
- 4) Press ◀▶ to switch the item.

[KEEP CURRENT STATE]	When the projector is switched off, the projector turns into standby with the shutter status left as is.
[OPEN]	When the projector is switched off, the projector turns into standby with the shutter left opened.
[CLOSE]	When the projector is switched off, the projector turns into standby with the shutter left closed.

**[FREEZE]**

Freeze the projected image temporarily regardless of the playback of the external device.

- 1) Press ▲▼ to select [FREEZE].
- 2) Press the <ENTER> button.
  - Press the <MENU> button to release.

**Note**

- [FREEZE] is displayed on the screen while freezing the image.
- The image may momentarily be disrupted before stopping when the image is stopped by operating [FREEZE] while the moving image is projecting.

**[WAVEFORM MONITOR]**

Use the input signals from a connected external device to display in a waveform. Check whether video output (luminance) signal level is within the recommended range for the projector and adjust.

- 1) Press ▲▼ to select [WAVEFORM MONITOR].
- 2) Press ◀▶ to switch the item.

[OFF]	Does not display the waveform monitor.
[ON]	Displays the waveform monitor.

- 3) Press the <MENU> button two times to clear.
- 4) Press ▲▼ to select any horizontal line.
- 5) Press the <ENTER> button to switch the Select line to either luminance, red, green, or blue.
  - Line selection items switch each time the <ENTER> is pressed only when the waveform monitor is displayed.

“Select line (luminance)”	Displayed in white waveform.
“Select line (red)”	Displayed in red waveform.
“Select line (green)”	Displayed in green waveform.
“Select line (blue)”	Displayed in blue waveform.

**Note**

- Setting is also available by [FUNCTION BUTTON] (➔ page 124).
- The waveform monitor cannot be displayed during [P IN P].
- The waveform monitor turns off when [P IN P] is executed during waveform monitoring.
- The waveform monitor is not displayed when on-screen display is hidden (off).

**Adjusting the waveform**

Project the luminance adjustment signal of a commercial test disk (0 % (0 IRE or 7.5 IRE) – 100 % (100 IRE)) and adjust.

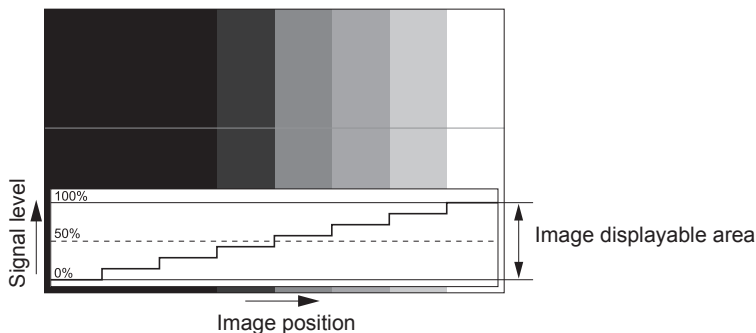

- 1) Select “Select line (luminance)” on the waveform monitor.
- 2) Adjust black level.
  - Use [BRIGHTNESS] in the on-screen menu [PICTURE] to adjust the black level 0 % of the video signal to the 0 % position of the waveform monitor.
- 3) Adjust white level.
  - Use [CONTRAST] in the on-screen menu [PICTURE] to adjust the white level 100 % of the video signal to the 100 % position of the waveform monitor.

**Adjusting red, green, and blue**

- 1) Set [COLOR TEMPERATURE] to [USER1] or [USER2] (➔ page 77).
- 2) Select “Select line (red)” on the waveform monitor.
- 3) Adjust dark red areas.
  - Use [RED] in [WHITE BALANCE LOW] to adjust the black level 0 % of the video signal to the 0 % position of the waveform monitor.
- 4) Adjust bright red areas.
  - Use [RED] in [WHITE BALANCE HIGH] to adjust the white level 100 % of the video signal to the 100 % position of the waveform monitor.
- 5) Use the procedure for [RED] to adjust [GREEN] and [BLUE].

**Note**

- For DVI-D signal, HDMI signal, SDI signal, and DIGITAL LINK signal, confirm that the [SIGNAL LEVEL] setting is correct before adjusting the black level. (SDI signal is supported only for PT-DZ780.)

## [CUT OFF]

---

Each red, green, and blue color component can be removed.

- 1) Press ▲▼ to select [CUT OFF].
- 2) Press the <ENTER> button.
  - The [CUT OFF] screen is displayed.
- 3) Press ▲▼ to select [RED], [GREEN], or [BLUE].
- 4) Press ◀▶ to switch the item.

[OFF]	Disables cutoff.
[ON]	Enables cutoff.

---

### Note

- When input is switched or a signal is switched, the cutoff setting returns to its original setting (off).

## [PROJECTOR SETUP] menu

On the menu screen, select [PROJECTOR SETUP] from the main menu, and select an item from the sub-menu.

Refer to “Navigating through the menu” (➔ page 71) for the operation of the menu screen.

- After selecting the item, press ▲▼◀▶ to set.

### [PROJECTOR ID]

The projector has an ID number setting function that can be used when multiple projectors are used side by side to enable simultaneous control or individual control via a single remote control.

- 1) Press ▲▼ to select [PROJECTOR ID].
- 2) Press ◀▶ to switch the item.
  - The items will switch each time you press the button.

[ALL]	Select this item to control projectors without specifying an ID number.
[1] - [64]	Select this item to control individual projector by specifying an ID number.

#### Note

- To specify an ID number for individual control, the ID number of a remote control must match the ID number of the projector.
- When the ID number is set to [ALL], the projector will operate regardless of the ID number specified during remote control or computer control.  
If multiple projectors are set up side by side with IDs set to [ALL], they cannot be controlled separately from the projectors with other ID numbers.
- Refer to “Setting the remote control ID numbers” (➔ page 69) for how to set the ID number on the remote control.

### [PROJECTION METHOD]

Set the projection method in accordance with the installation status of the projector.

Change the projection method if the screen display is upside down or inverted.

- 1) Press ▲▼ to select [PROJECTION METHOD].
- 2) Press the <ENTER> button.
  - The [PROJECTION METHOD] screen is displayed.
- 3) Press ▲▼ to select the projection method.

[FRONT/FLOOR]	When installing the projector on the desk, etc., in front of the screen
[FRONT/CEILING]	When installing the projector in front of the screen using the Ceiling Mount Bracket (optional)
[REAR/FLOOR]	When installing the projector on the desk, etc., behind the screen (with a translucent screen)
[REAR/CEILING]	When installing the projector behind the screen (with a translucent screen) using the Ceiling Mount Bracket (optional)

- 4) Press the <ENTER> button.
- 5) When the confirmation screen is displayed, press ◀▶ to select [OK], and press the <ENTER> button.

#### Attention

- When the [PROJECTION METHOD] setting is changed, confirm that [COOLING CONDITION] (➔ page 112) is set correctly.

## [COOLING CONDITION]

Change the fan control depending on the direction of projection.

Set [COOLING CONDITION] according to the projection direction, but set it to [AUTO] normally. Using the projector with [COOLING CONDITION] set incorrectly may shorten the life of the lamp.

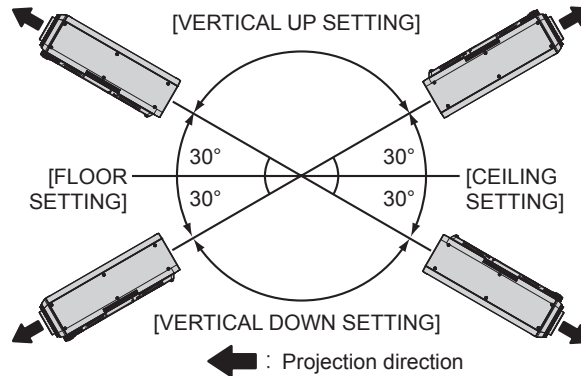

- 1) Press ▲▼ to select [COOLING CONDITION].
- 2) Press the <ENTER> button.
  - The [COOLING CONDITION] screen is displayed.
- 3) Press ▲▼ to select a cooling condition.
  - When [AUTO] is selected, the cooling conditions of [FLOOR SETTING], [CEILING SETTING], [VERTICAL UP SETTING], and [VERTICAL DOWN SETTING] are set automatically.
  - You can check the setting from [COOLING CONDITION] on the [STATUS] screen.
- 4) Press the <ENTER> button.
- 5) When the confirmation screen is displayed, press ◀▶ to select [OK], and press the <ENTER> button.

## [LAMP SELECT]

Select the lamp to be turned on from the two built-in luminous lamps according to the usage conditions or purposes.

- 1) Press ▲▼ to select [LAMP SELECT].
- 2) Press ◀▶ to switch the item.

[DUAL]	Two lamps will light.
[SINGLE]	One lamp will light. (The lamps with shorter runtime will automatically light.)
[LAMP1]	Lamp 1 will light.
[LAMP2]	Lamp 2 will light.

- 3) Press the <ENTER> button.

### Note

- For a certain time after [LAMP SELECT] is switched, [LAMP SELECT] cannot be switched again, because the lamp replacement cycle will be shortened. Repeatedly switching [LAMP SELECT] in a short time will also shorten the lamp replacement cycle.
- The colors of the items indicate the status.

Green	Current setting
Yellow	Current setting (when there is a lamp that cannot turn on or failed to turn on)
Red	Lamp that has failed to turn on
White	Any other status

- When [SINGLE], [LAMP1], or [LAMP2] is selected, if the lamp turns off or if the runtime exceeds 4 000 hours (when [LAMP POWER] is set to [NORMAL]), the other lamp turns on. When [DUAL] is selected, if either lamp turns off or if the runtime of either lamp exceeds 4 000 hours (when [LAMP POWER] is set to [NORMAL]), only the other lamp remains on. However, if both lamps turn off or if runtimes of both lamps exceed 4 000 hours (when [LAMP POWER] is set to [NORMAL]), the projector turns into standby.
- Ensure that the lamp unit which is not to be turned on is also installed.
- If the setting is switched to [SINGLE], [LAMP1], or [LAMP2], both lamps turn on temporarily to prevent illuminance reduction.



**[LAMP RELAY]**

Switch the lamp to be turned on automatically by specifying the day of the week and time.

The degradation of the lamp due to continuous usage can be reduced by automatically switching the lamp to be turned on when using the projector continuously for a week or more.

1) Press ▲▼ to select [LAMP RELAY].

2) Press ◀▶ to switch the item.

[OFF]	Disables lamp relay.
[24H]	Switches the lamp daily.
[1WEEK]	Switches the lamp weekly.

- When [24H] or [1WEEK] is selected, proceed to Step 3).

3) Press ▲▼ to select [TIME].

4) Press the <ENTER> button.

- The projector enters adjustment mode (the display is blinking).

5) Press ◀▶ to select “hour” or “minute”, and press ▲▼ or the number (<0> - <9>) buttons to set a time.

- Selecting “hour” allows setting of only the hour in increments of one hour, and selecting “minute” allows setting of only the minute in increments of one minute between 00 and 59.

6) Press the <ENTER> button.

- The adjusted time is set.
- When [1WEEK] is selected in Step 2), proceed to Step 7).

7) Press ▲▼ to select [DAY OF THE WEEK].

8) Press ◀▶ to switch the item.

[SUNDAY]	Switches the lamp automatically on the set day of the week.
[MONDAY]	
[TUESDAY]	
[WEDNESDAY]	
[THURSDAY]	
[FRIDAY]	
[SATURDAY]	

**Note**

- The [LAMP RELAY] function is enabled when [DUAL] or [SINGLE] is selected in [LAMP SELECT].
- When [DUAL] is selected in [LAMP SELECT], only one lights for four hours from the specified time.
- The operating time will be the local time. (➔ page 124)

**[LAMP POWER]**

Switch the brightness of the lamp according to the operating environment of the projector or the purpose.

1) Press ▲▼ to select [LAMP POWER].

2) Press ◀▶ to switch the item.

[NORMAL]	Select this item when high luminance is required.
[ECO]	Select this item when high luminance is not required.

**Note**

- When [ECO] is set, you can reduce power consumption and operation noise, and extend the life of the lamp.

**[BRIGHTNESS CONTROL]**

The projector is equipped with a luminance sensor to measure brightness and functions to correct screen brightness resulting from changes in lamp brightness.

By using this function, it is possible to reduce changes in overall brightness of the multiple screens due to lamp degradation and suppress variation in brightness to preserve uniformity when constructing multiple screens using multiple projectors.

**Setting [BRIGHTNESS CONTROL GAIN]**

Adjust the brightness when displaying multiple screens using multiple projectors.

- 1) Press ▲▼ to select [BRIGHTNESS CONTROL].
- 2) Press the <ENTER> button.
  - The [BRIGHTNESS CONTROL] screen is displayed.
- 3) Press ▲▼ to select [BRIGHTNESS CONTROL GAIN].
- 4) Press ◀▶ to adjust.

Operation	Adjustment		Range of adjustment
	Brightness	Maximum amount of brightness correction	
Press ▶.	The screen becomes brighter.	The maximum amount of correction is reduced.	20 % - 100 %
Press ◀.	The screen becomes darker.	The maximum amount of correction is increased.	

**Note**

- When using only one projector, the value obtained by subtracting the value of the [BRIGHTNESS CONTROL GAIN] from 100 % is the maximum amount of brightness correction. Brightness cannot be corrected through brightness control since the maximum amount of correction becomes 0 % when [BRIGHTNESS CONTROL GAIN] is at 100 %.
- Luminance will be unsteady for eight minutes after a lamp is turned on. Make adjustments at least eight minutes after starting projection.
- The result of [BRIGHTNESS CONTROL GAIN] adjustments is reflected on all video signals, internal test patterns, and on-screen menus.
- The [BRIGHTNESS CONTROL GAIN] setting is enabled even if [BRIGHTNESS CONTROL SETUP] is [OFF].

**Setting [BRIGHTNESS CONTROL SETUP]**

Set brightness control operation.

- 1) Press ▲▼ to select [BRIGHTNESS CONTROL].
- 2) Press the <ENTER> button.
  - The [BRIGHTNESS CONTROL] screen is displayed.
- 3) Press ▲▼ to select [BRIGHTNESS CONTROL SETUP].
- 4) Press the <ENTER> button.
  - The [BRIGHTNESS CONTROL SETUP] screen is displayed.
- 5) Press ▲▼ to select [MODE].
- 6) Press ◀▶ to switch the item.
  - The items will switch each time you press the button.

[OFF]	Does not correct the brightness of the screen by the brightness sensor.
[AUTO]	Corrects the brightness of the screen by the brightness sensor. Automatically corrects screen brightness when lamp brightness changes.
[PC]	Synchronizes nine or more projectors through a computer using the dedicated software "Multi Projector Monitoring & Control Software"*1.

\*1 "Multi Projector Monitoring & Control Software" is included in the supplied CD-ROM.

- When [PC] is selected, proceed to Step 9).

- 7) Press ▲▼ to select [LINK].

8) Press ◀▶ to switch the item.

- The items will switch each time you press the button.

[OFF]	Performs corrections by the brightness sensor on one projector without synchronizing with the other projectors. The duration that the constant brightness is kept will become longer by setting the value of [BRIGHTNESS CONTROL GAIN] smaller.
[GROUP A] [GROUP B] [GROUP C] [GROUP D]	Synchronizes corrections in multiple projectors by the brightness sensor. You can set up to four groups (A to D) within the same subnet by using the network function. You can also register and synchronize up to eight projectors in one group.

9) Press ▲▼ to select [CALIBRATION TIME].

10) Press the <ENTER> button.

- The projector is in the adjustment mode (where the time is blinking).

11) Press ◀▶ to select “hour” or “minute”, and press ▲▼ or the number (<0> - <9>) buttons to set a time.

- Selecting “hour” allows setting of only the hour in increments of one hour, and selecting “minute” allows setting of only the minute in increments of one minute between 00 and 59.
- If you do not specify the time, select [OFF] between 23 and 00 o'clock or between 59 and 00 minutes.

12) Press the <ENTER> button.

- [CALIBRATION TIME] is set.
- The brightness is measured at the specified time.

13) Press ▲▼ to select [CALIBRATION MESSAGE].

14) Press ◀▶ to switch the item.

- The items will switch each time you press the button.

[ON]	Messages are displayed during calibration.
[OFF]	Messages are not displayed during calibration.

15) Press ▲▼ to select [APPLY].

16) Press the <ENTER> button.

- The set [MODE] and [LINK] are enabled, and the lamp relay screen alert is displayed when the [LAMP RELAY] setting is [OFF]. When [CALIBRATION MESSAGE] is set to [ON], a calibration running message is displayed which will automatically disappear 30 seconds after calibration completes.
- If the <ENTER> button is pressed with [MODE] in [BRIGHTNESS CONTROL SETUP] set to other than [OFF], the brightness of the lamp at the time the button was pressed is recorded as the standard brightness.
- If the <ENTER> button is pressed while [LINK] is set between [GROUP A] and [GROUP D], the group name is displayed on the screens of projectors that have been set in the same group.



**Note**

- When [MODE] in [BRIGHTNESS CONTROL SETUP] is set to [AUTO] or [PC], keep the shutter function disabled (shutter: open) for at least two minutes to perform the brightness sensor calibration after the [BRIGHTNESS CONTROL SETUP] setting has been completed.
- If the shutter function is enabled (shutter: closed) within approx. 10 minutes after the lamp has turned on while [MODE] in [BRIGHTNESS CONTROL SETUP] is set to [AUTO] or [PC], brightness cannot be measured. Therefore, brightness may be corrected approx. two minutes after the shutter function is disabled (shutter: open).
- When [MODE] in [BRIGHTNESS CONTROL SETUP] is set to [AUTO] or [PC], the lamp brightness is automatically measured eight minutes after the lamp is turned on, and correction is performed so that the screen brightness will be the same as the standard brightness when the brightness control is adjusted. Lamp brightness cannot be measured during the eight minutes after it is turned on because it is not steady.
- If a lamp turns off or lamp relay is performed while [MODE] in [BRIGHTNESS CONTROL SETUP] is set to [AUTO] and when the [PROJECTOR SETUP] menu → [LAMP SELECT] is set to [DUAL], brightness is corrected to the possible extent one minute later.
- When the projector is operating with [MODE] in [BRIGHTNESS CONTROL SETUP] set to [AUTO] and [LINK] set to [OFF], brightness correction is corrected until it reaches the maximum correction value.
- The variation in brightness may increase due to dust accumulating on the lens, screen, or inside the projector, depending on the installation environment of the projector.
- Adjust brightness control again when lamp degradation causes increased variation in brightness or a lamp is replaced.

- For continued use longer than 24 hours, set [BRIGHTNESS CONTROL SETUP] to [CALIBRATION TIME], or set [LAMP RELAY] (➔ page 113). If it is not set, correction will not be performed automatically.
- The [CALIBRATION TIME] setting will be reflected at the time when you enter the time.
- The [CALIBRATION MESSAGE] setting will be reflected at the time when items are switched using ◀▶.

### Displaying [BRIGHTNESS CONTROL STATUS]

Display the brightness control status.

- 1) Press ▲▼ to select [BRIGHTNESS CONTROL].
- 2) Press the <ENTER> button.
  - The [BRIGHTNESS CONTROL] screen is displayed.
- 3) Press ▲▼ to select [BRIGHTNESS CONTROL STATUS].
- 4) Press the <ENTER> button.
  - The [BRIGHTNESS CONTROL STATUS] screen is displayed.

### [BRIGHTNESS CONTROL STATUS] screen display example

When [MODE] of [BRIGHTNESS CONTROL SETUP] is set to [OFF]

The screen shows the status that the brightness control is disabled.

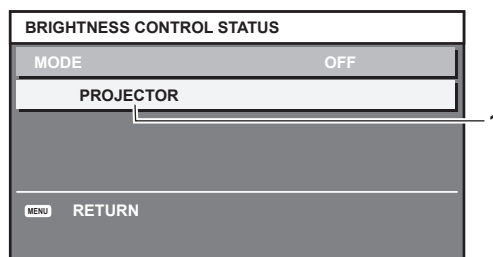

When [MODE] of [BRIGHTNESS CONTROL SETUP] is set to [AUTO] and [LINK] is set from [GROUP A] to [GROUP D]

The screen shows the status of the brightness control of synchronized projectors (up to eight units), including the projector being controlled through the on-screen menu.

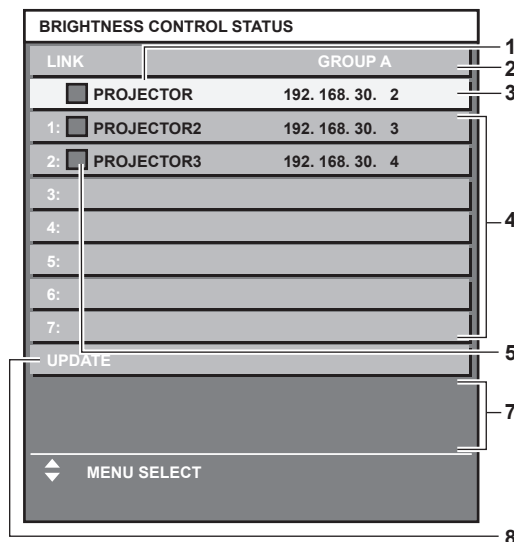

**When [MODE] of [BRIGHTNESS CONTROL SETUP] is set to [AUTO] and [LINK] is set to [OFF]**

The screen shows the status of the brightness control in one projector

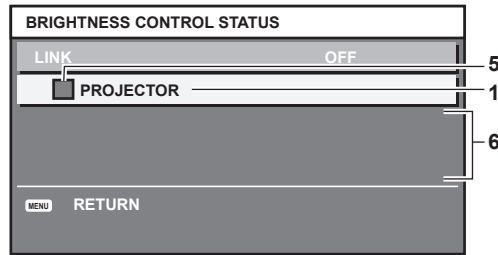

**When [MODE] of [BRIGHTNESS CONTROL SETUP] is set to [PC]**

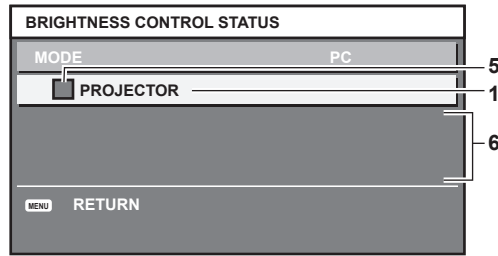

- 1 Display the name of the projector.
- 2 Display the synchronized group.
- 3 Display the IP address of the projector.
- 4 Display the names and IP addresses of projectors in same group detected over the network.
- 5 Display the status by color.  
Green: There is an allowance for brightness correction.  
Yellow: There is little allowance for brightness correction.  
Red: There is a brightness control error.
- 6 Display error detailed messages.
- 7 Display error messages.  
When the message [Failed to apply BRIGHTNESS CONTROL to some projectors.] appears, it means that synchronization with the projector displayed in red has failed.  
Press ▲▼ to select the projector displayed in red, and press the <ENTER> button to display the error details.
- 8 Update to the latest status information.

■ Error details

Error message	Measures to take
[Exceed maximum number of projectors.]	<ul style="list-style-type: none"> <li>• Limit the number of projectors in one group to eight.</li> <li>• When synchronizing nine or more projectors, use the dedicated software “Multi Projector Monitoring &amp; Control Software”<sup>*1</sup> through a computer.</li> </ul>
[Please check the COMMAND CONTROL setting.]	<ul style="list-style-type: none"> <li>• Set [NETWORK CONTROL] → [COMMAND CONTROL] to [ON] for the projector in error.</li> <li>• Set [NETWORK CONTROL] → [COMMAND PORT] of all projectors to be linked to the same value.</li> </ul>
[Please check the USER NAME and PASSWORD in the COMMAND CONTROL setting.]	<ul style="list-style-type: none"> <li>• Assign the same [User name] and [Password] strings that have web control administrator rights to all projectors to be linked.</li> </ul>
[Cannot apply BRIGHTNESS CONTROL. Please check projector status.]	<ul style="list-style-type: none"> <li>• The projector is in standby. Switch on the power.</li> </ul>
[Brightness Sensor Error]	<ul style="list-style-type: none"> <li>• There is a problem with the brightness sensor. If problems persist even after switching on the power, consult your dealer.</li> </ul>

\*1 “Multi Projector Monitoring & Control Software” is included in the supplied CD-ROM.

**Note**

- If the synchronized projectors are not displayed in the list, check the following:
  - Are there devices with the same IP address on the network?
  - Are the LAN cables connected correctly? (➡ page 142)
  - Are the subnets of the projectors the same?
  - Are the same [LINK] settings applied to a group?
- Refer to [NETWORK SETUP] (➡ page 139) or “[Network config] page” (➡ page 151) on how to change the projector name.

**Brightness control adjustment procedure example**

The steps exemplify an adjustment to link the brightness of eight projectors connected in a network.

- 1) **Connect all projectors to the hub using LAN cables. (➡ page 142)**
- 2) **Switch on all projectors and start projection.**
- 3) **Set [LAMP SELECT] to either [DUAL] or [SINGLE] for all projectors.**
- 4) **Set [MODE] of [BRIGHTNESS CONTROL SETUP] to [OFF], and select [APPLY], and then press the <ENTER> button.**
- 5) **Set [SUBNET MASK] and [IP ADDRESS] in each projector.**
  - To be able to communicate over the network, set the same value in [SUBNET MASK] for all projectors and set a different value in [IP ADDRESS] for each projector.
- 6) **Wait for at least eight minutes after starting projection until the lamp brightness becomes steady.**
- 7) **Set all items in the [PICTURE] menu of all projectors to the same values.**
- 8) **Adjust [COLOR MATCHING] to match colors.**
- 9) **Display the internal test pattern “All white” in all projectors.**
- 10) **Set [BRIGHTNESS CONTROL GAIN] to 100 % in all projectors.**
- 11) **Set [BRIGHTNESS CONTROL GAIN] to 90 % in the projector with the least brightness.**
- 12) **Adjust [BRIGHTNESS CONTROL GAIN] of each projector.**
  - Adjust [BRIGHTNESS CONTROL GAIN] of all the other projectors so that the brightness is matched to the projector of which [BRIGHTNESS CONTROL GAIN] is set to 90 %.
- 13) **Set [MODE] of [BRIGHTNESS CONTROL SETUP] to [AUTO], and [LINK] to [GROUP A] on all projectors.**
- 14) **Select [APPLY] of [BRIGHTNESS CONTROL SETUP] and press the <ENTER> button in all projectors.**
  - Brightness control starts.

**Note**

- Brightness is automatically corrected each time the lamp lights when the power is switched on or off.
- Adjust brightness control again when lamp degradation causes increased variation in brightness or the lamp is replaced.

**[STANDBY MODE]**

Set the power consumption during the standby.

- 1) **Press ▲▼ to select [STANDBY MODE].**
- 2) **Press ◀▶ to switch the item.**
  - The items will switch each time you press the button.

<b>[NORMAL]</b>	Select this item to use the network function during standby.
<b>[ECO]</b>	Select this item to reduce power consumption during standby.

**Note**

- When [ECO] is set, the network function, the <SERIAL OUT> terminal, and some RS-232C commands become inoperable during standby. In the [NORMAL] setting, the network function and the <SERIAL OUT> terminal become operable during standby.
- When [ECO] is set, it may take approximately 10 seconds longer before the projector starts projecting after the power is turned on, compared with when [NORMAL] is set.
- The [STANDBY MODE] settings are not reset to the factory defaults even when [ALL USER DATA] is executed from the [PROJECTOR SETUP] menu → [INITIALIZE] (➡ page 126).

**[SCHEDULE]**

Set the command execution schedule for each day of the week.

**Enabling/disabling the schedule function**

- 1) Press ▲▼ to select [SCHEDULE].
- 2) Press ◀▶ to switch the item.
  - The items will switch each time you press the button.

[OFF]	Disables the schedule function.
[ON]	Enables the schedule function. Refer to “How to assign a program” (➔ page 119) or “How to set a program” (➔ page 119) for how to set the schedule.

**Note**

- When [SCHEDULE] is set to [ON], the [STANDBY MODE] setting is forcibly switched to [NORMAL], and the setting cannot be changed. Even if [SCHEDULE] is then set to [OFF] when in this state, the setting of [STANDBY MODE] remains at [NORMAL].

**How to assign a program**

- 1) Press ▲▼ to select [SCHEDULE].
- 2) Press ◀▶ to select [ON], and press the <ENTER> button.
  - The [SCHEDULE] screen is displayed.
- 3) Select and assign program to each day of week.
  - Press ▲▼ to select the day of week, and press ◀▶ to select a program number.
  - You can set the program from No.1 to No.7. “- - -” indicates that the program number has not been set.

**How to set a program**

Set up to 16 commands to each program.

- 1) Press ▲▼ to select [SCHEDULE].
- 2) Press ◀▶ to select [ON], and press the <ENTER> button.
  - The [SCHEDULE] screen is displayed.
- 3) Press ▲▼ to select [PROGRAM EDIT].
- 4) Press ◀▶ to select a program number, and press the <ENTER> button.
- 5) Press ▲▼ to select a command number, and press the <ENTER> button.
  - You can change the page using ◀▶.
- 6) Press ▲▼◀▶ to select [TIME], and press the <ENTER> button.
  - The projector is in the adjustment mode (where the time is blinking).
- 7) Press ◀▶ to select “hour” or “minute”, and press ▲▼ or the number (<0> - <9>) buttons to set a time, and then press the <ENTER> button.
- 8) Press ▲▼◀▶ to select [COMMAND].
- 9) Press the <ENTER> button.
  - The [COMMAND] detailed screen is displayed.
- 10) Press ▲▼ to select a [COMMAND].
  - For [COMMAND] which requires detailed settings, the items of the detailed settings will switch each time you press ◀▶.
  - When [INPUT] is selected, press the <ENTER> button, and then press ▲▼◀▶ to select the input to be set.

[COMMAND]	Detailed settings of [COMMAND]	Description
[POWER ON]	—	Switches on the projector.
[STANDBY]	—	Enters standby.
[SHUTTER]	[OPEN]	Disables the shutter function (shutter: open).
	[CLOSE]	Enables the shutter function (shutter: closed).
[INPUT]	[RGB1]	Switches the input to RGB1.
	[RGB2]	Switches the input to RGB2.
	[DVI-D]	Switches the input to DVI-D.
	[HDMI]	Switches the input to HDMI.
	[DIGITAL LINK]	Switches the input to DIGITAL LINK.
	[SDI]* <sup>1</sup>	Switches the input to SDI.
	[INPUT1] - [INPUT10]* <sup>2</sup>	Switches the input to DIGITAL LINK, and switches the input of the Panasonic twisted-pair-cable transmitter to the specified input.
[LAMP SELECT]	[DUAL]	Turns on two lamps.
	[SINGLE]	Turns on one lamp. (The lamp with shorter runtime will automatically light.)
[LAMP POWER]	[NORMAL]	Sets the lamp brightness to high luminance.
	[ECO]	Sets the lamp brightness to low luminance.
[P IN P]	[OFF]	P IN P function is not used.
	[USER1]	Lays out the sub-screen with the settings of [USER1].
	[USER2]	Lays out the sub-screen with the settings of [USER2].
	[USER3]	Lays out the sub-screen with the settings of [USER3].

\*1 Only for PT-DZ780

\*2 When the optional DIGITAL LINK output supported device (Model No.: ET-YFB100G, ET-YFB200G) is connected to the projector, its input name is automatically reflected from [INPUT1] to [INPUT10]. If an item where the input name is not reflected is selected, it is disabled.

**11) Press the <ENTER> button.**

- The command is fixed and ● is displayed at the left of the selected command.
- After the command is fixed, press the <MENU> button to close the detailed setting screen.

**12) Press ▲▼◀▶ to select [STORE], and press the <ENTER> button.**

**Note**

- If you attempt to register the setting that would make the lamp turn on for a short time, an error message will be displayed on the screen. Set the time and command again.
- To delete a command that has been already set, press the <DEFAULT> button on the remote control while the screen in Step 5) is displayed, or select [DELETE] at the screen in Step 6) and press the <ENTER> button.
- If multiple commands have been set for the same time, they are executed in chronological order starting from the smallest command number.
- The operating time will be the local time. (➔ page 124)
- If an operation is executed with the remote control or control panel of the projector or with a control command before the command set in [SCHEDULE] is executed, the command set with the schedule function may not be executed.

**[INITIAL STARTUP]**

Set the startup method when the <MAIN POWER> switch is set to <ON>.

**1) Press ▲▼ to select [INITIAL STARTUP].**

**2) Press ◀▶ to switch the item.**

- The items will switch each time you press the button.

[LAST MEMORY]	Starts up the projector in the condition before the <MAIN POWER> switch is set to <OFF>.
[STANDBY]	Starts up the projector in standby.
[ON]	Starts up projecting immediately.

**[STARTUP INPUT SELECT]**

Set the input when the projector is switched on to start projection.

**1) Press ▲▼ to select [STARTUP INPUT SELECT].**

**2) Press the <ENTER> button.**

- The [STARTUP INPUT SELECT] screen is displayed.



3) Press ▲▼◀▶ to select an item.

[LAST USED]	Keeps the input selected last.
[RGB1]	Sets the input to RGB1.
[RGB2]	Sets the input to RGB2.
[DVI-D]	Sets the input to DVI-D.
[HDMI]	Sets the input to HDMI.
[DIGITAL LINK]	Sets the input to DIGITAL LINK.
[SDI]*1	Sets the input to SDI.
[INPUT1] - [INPUT10]*2	Sets the input to DIGITAL LINK, and switches the input of Panasonic twisted-pair-cable transmitter to the specified input.

\*1 Only for PT-DZ780

\*2 When the optional DIGITAL LINK output supported device (Model No.: ET-YFB100G, ET-YFB200G) is connected to the projector, its input name is automatically reflected from [INPUT1] to [INPUT10]. If an item where the input name is not reflected is selected, it is disabled.

**Note**

- When [BACKUP INPUT MODE] in the [DISPLAY OPTION] menu → [BACKUP INPUT SETTING] (➔ page 97) has been set to [ON], and the projector has been turned off with the input set to HDMI, projection will start with the DVI-D input, even when [STARTUP INPUT SELECT] is set to [LAST USED].

**[RS-232C]**

Set the communication conditions of the <SERIAL IN>/<SERIAL OUT> terminals. Refer to “<SERIAL IN>/<SERIAL OUT> terminal” (➔ page 180).

**Setting the communication condition of the <SERIAL IN> terminal**

- 1) Press ▲▼ to select [RS-232C].
- 2) Press the <ENTER> button.
  - The [RS-232C] screen is displayed.
- 3) Press ▲▼ to select [INPUT SELECT].
- 4) Press ◀▶ to switch the item.

[PROJECTOR]	Use the <SERIAL IN> terminal of the projector to perform RS-232C communication.
[DIGITAL LINK]	Performs RS-232C communication via the DIGITAL LINK output supported device (Model No.: ET-YFB100G, ET-YFB200G) and the <DIGITAL LINK/LAN> terminal.

- 5) Press ▲▼ to select [(IN) BAUDRATE].
- 6) Press ◀▶ to switch the item.
  - The items will switch each time you press the button.

[9600]	Select the proper speed.
[19200]	
[38400]	

- 7) Press ▲▼ to select [(IN) PARITY].
- 8) Press ◀▶ to switch the item.
  - The items will switch each time you press the button.

[NONE]	Select the parity condition.
[EVEN]	
[ODD]	

**Setting the communication condition of the <SERIAL OUT> terminal**

- 1) Press ▲▼ to select [RS-232C].

- 2) Press the <ENTER> button.
  - The [RS-232C] screen is displayed.
- 3) Press ▲▼ to select [(OUT) BAUDRATE].
- 4) Press ◀▶ to switch the item.

[9600]	Select the proper speed.
[19200]	
[38400]	

- 5) Press ▲▼ to select [(OUT) PARITY].
- 6) Press ◀▶ to switch the item.
  - The items will switch each time you press the button.

[NONE]	Select the parity condition.
[EVEN]	
[ODD]	

### Setting the response

- 1) Press ▲▼ to select [RS-232C].
- 2) Press the <ENTER> button.
  - The [RS-232C] screen is displayed.
- 3) Press ▲▼ to select [RESPONSE(ID ALL)].
- 4) Press ◀▶ to switch the item.

[ON]	Returns the response when the ID setting is ALL.
[OFF]	Does not return the response when the ID setting is ALL.

- 5) Press ▲▼ to select [GROUP].
- 6) Press ◀▶ to switch the item.

[A] - [Z]	Controls multiple projectors simultaneously by sending the ID of RS-232C. You can set groups from [A] to [Z]. The projector responds when the ID of RS-232C matches the setting.
-----------	--

- 7) Press ▲▼ to select [RESPONSE(ID GROUP)].
- 8) Press ◀▶ to switch the item.

[ON]	Returns the response when the ID setting is GROUP.
[OFF]	Does not return the response when the ID setting is GROUP.

### Note

- When [INPUT SELECT] is set to [DIGITAL LINK], communication using that serial terminal is available only when the corresponding device (such as the optional DIGITAL LINK output supported device (Model No.: ET-YFB100G, ET-YFB200G)) is connected to the <DIGITAL LINK/LAN> terminal.
- When transferring logos via the optional DIGITAL LINK output supported device (Model No.: ET-YFB100G, ET-YFB200G), setting for “NO SIGNAL SLEEP” of the DIGITAL LINK output supported device should be set to “OFF” to avoid interruption of communication.
- When [INPUT SELECT] is set to [DIGITAL LINK], communication speed is fixed to 9 600 bps.

### [STATUS]

Display the status of the projector.

- 1) Press ▲▼ to select [STATUS].
- 2) Press the <ENTER> button.
  - The [STATUS] screen is displayed.

3) Press ◀▶ to switch the pages.

- The page will change each time you press the button.

[PROJECTOR TYPE]	Displays the projector type and serial number of the projector.	
[PROJECTOR RUNTIME]	Displays the runtime of the projector.	
[LAMP1]* <sup>3</sup>	Displays the runtime and status of the lamp 1.	
[LAMP2]* <sup>3</sup>	Displays the runtime and status of the lamp 2.	
[MAIN/SUB VERSION]	Displays the main and sub versions of the firmware of the projector.	
[INTAKE AIR TEMP.]* <sup>1</sup>	Displays the status of the intake air temperature of the projector.	
[OPTICS MODULE TEMP.]* <sup>1</sup>	Displays the status of the internal temperature of the projector.	
[EXHAUST AIR TEMP.]* <sup>1</sup>	Displays the status of the exhaust air temperature of the projector.	
[COOLING CONDITION]	Displays the set cooling conditions. When [AUTO] is set, automatically recognized result is displayed.	
[ATMOSPHERIC PRESSURE]	Displays the atmospheric pressure.	
[SELF TEST]	Displays the status of the projector.	
[INPUT]	Displays the input terminal currently selected.	
[BACKUP INPUT STATUS]	Displays the backup status.	
[SIGNAL NAME]	Displays the input signal name.	
[SIGNAL FREQUENCY]	Displays the frequency of the input signal.	
[NUMBER OF REGISTERED SIGNAL]	Displays the number of registered signals.	
[REMOTE2 STATUS]	Displays the control status of the REMOTE2.	
[AC VOLTAGE]	Displays the status of the AC voltage.	
[LAMP UNIT MODEL NO.]	Displays the model no. of the lamp unit.	
[LAMP1 SERIAL NUMBER]	Displays the serial number of the lamp 1.	
[LAMP2 SERIAL NUMBER]	Displays the serial number of the lamp 2.	
[UPGRADE]* <sup>2</sup>	[ET-UK20]	Displays the activation status based on the Upgrade Kit (Model No.: ET-UK20).
	[ET-CUK10]	Displays the activation status based on the Auto Screen Adjustment Upgrade Kit (Model No.: ET-CUK10).
[ON COUNT]	[POWER ON TIMES]	Displays the number of times the power is turned on.
	[LAMP1 ON]	Displays the number of times the lamp is turned on.
	[LAMP2 ON]	
	[SHUTTER]	Displays the number of times the shutter is closed.
[LAMP1]	Displays the runtime in detail.	
[LAMP2]	Displays the runtime in detail.	
[SIGNAL INFORMATION]	[MEMORY NO.]	Displays the memory number of the input signal.
	[INPUT]	Displays the input terminal currently selected.
	[SIGNAL NAME]	Displays the input signal name.
	[SIGNAL FREQUENCY]	Displays the frequency of the input signal.
	[SYNC.STATE]	Displays the synch polarity of the input signal.
	[V.SYNC WIDTH]	Displays the vertical sync signal pulse width of the input signal.
	[SCAN TYPE]	Displays the scan type of the input signal.
	[TOTAL DOTS]	Displays the total dot count of the input signal.
	[DISPLAY DOTS]	Displays the number of input signal display dots.
	[TOTAL LINES]	Displays the total line count of the input signal.
	[DISPLAY LINES]	Displays the number of input signal display lines.
	[SAMPLING]	Displays the sampling information of the input signal.
[SIGNAL LEVEL]	Displays the signal level of the input signal.	
	[BIT DEPTH]* <sup>2</sup>	Displays the gradation of the input signal.

\*1 The temperature status is indicated with text color (green/yellow/red) and bar scale. Use the projector within the range that the indication is green.

\*2 Only for PT-DZ780

\*3 The lamp runtime to be displayed is real time. The following conversion is required to calculate the rough estimate for lamp replacement.

Formula for lamp replacement time (rough estimate)
$(A \times 6 + B \times 4) \div 6$ <ul style="list-style-type: none"> <li>• A: Runtime when [LAMP POWER] is set to [NORMAL]</li> <li>• B: Runtime when [LAMP POWER] is set to [ECO]</li> </ul>

**Note**

- E-mail including the content of status can be sent to the E-mail addresses (up to two addresses) set in "[E-mail set up] page" (➔ page 153) by pressing the <ENTER> button while displaying the [STATUS] screen.
- Some items in [SIGNAL INFORMATION] may be displayed and others not displayed, depending on the signal being input.
- If any abnormality has occurred on the projector, pressing the <DEFAULT> button while the [STATUS] screen is displayed shows the detail screen of the error information.
- For details on the contents displayed in [SELF TEST], refer to "[SELF TEST] indications" (➔ page 171).

**[NO SIGNAL SHUT-OFF]**

A function that automatically switches the power source of the projector to standby if there is no input signal for a certain period of time. The time before switching to standby can be set.

- 1) Press ▲▼ to select [NO SIGNAL SHUT-OFF].
- 2) Press ◀▶ to switch the item.
  - The items will switch each time you press the button.

[DISABLE]	Disables the No signal shut-off function.
[10MIN.] - [90MIN.]	Sets the time in increments of 10 minutes.

**[REMOTE2 MODE]**

You can set the <REMOTE 2 IN> terminal.

- 1) Press ▲▼ to select [REMOTE2 MODE].
- 2) Press ◀▶ to switch the item.
  - The items will switch each time you press the button.

[DEFAULT]	The pin assignment of the <REMOTE 2 IN> terminal is used by the factory default setting of the projector.
[USER]	Used to change the setting of the <REMOTE 2 IN> terminal. (➔ page 184)
[L6500 SERIES]	The setting of <REMOTE 2 IN> terminal is used for the L6500 series compatibility.

- When [USER] is selected, proceed to Step 3).

- 3) Press the <ENTER> button.
- 4) Press ▲▼ to select one from [PIN2] to [PIN8], and press ◀▶ to switch the setting.

**[FUNCTION BUTTON]**

Set the functions of the <FUNCTION> button on the remote control.

- 1) Press ▲▼ to select [FUNCTION BUTTON].
- 2) Press the <ENTER> button.
  - The [FUNCTION BUTTON] screen is displayed.
- 3) Press ▲▼ to select a function.

[DISABLE]	Disables the <FUNCTION> button.
[P IN P]	Switches the [P IN P] setting to [OFF], [USER1], [USER2], or [USER3]. (➔ page 128)
[SUB MEMORY]	Displays the sub memory list. (➔ page 133)
[SYSTEM SELECTOR]	Switches the [SYSTEM SELECTOR] setting. (➔ page 81)
[SYSTEM DAYLIGHT VIEW]	Switches the [SYSTEM DAYLIGHT VIEW] setting. (➔ page 80)
[FREEZE]	Freezes the image temporarily. (➔ page 108)
[WAVEFORM MONITOR]	Displays the waveform of the input signal. (➔ page 108)
[ASPECT]	Switches the aspect setting. (➔ page 83)

- 4) Press the <ENTER> button.

**[DATE AND TIME]**

Set the time zone, date, and time of the built-in clock of the projector.

### Setting the time zone

- 1) Press ▲▼ to select [DATE AND TIME].
- 2) Press the <ENTER> button.
  - The [DATE AND TIME] screen is displayed.
- 3) Press ▲▼ to select [TIME ZONE].
- 4) Press ◀▶ to switch [TIME ZONE].

### Setting the date and time manually

- 1) Press ▲▼ to select [DATE AND TIME].
- 2) Press the <ENTER> button.
  - The [DATE AND TIME] screen is displayed.
- 3) Press ▲▼ to select [ADJUST CLOCK].
- 4) Press the <ENTER> button.
  - The [ADJUST CLOCK] screen is displayed.
- 5) Press ▲▼ to select an item, and press ◀▶ to set the local date and time.
- 6) Press ▲▼ to select [APPLY], and press the <ENTER> button.
  - The setting of the date and time will be completed.

### Setting the date and time automatically

- 1) Press ▲▼ to select [DATE AND TIME].
- 2) Press the <ENTER> button.
  - The [DATE AND TIME] screen is displayed.
- 3) Press ▲▼ to select [ADJUST CLOCK].
- 4) Press the <ENTER> button.
  - The [ADJUST CLOCK] screen is displayed.
- 5) Press ▲▼ to select [NTP SYNCHRONIZATION], and press ◀▶ to change the setting to [ON].
- 6) Press ▲▼ to select [APPLY], and press the <ENTER> button.
  - The setting of the date and time will be completed.

#### Note

- To set the date and time automatically, the projector must be connected to the network.
- If synchronization with the NTP server fails just after [NTP SYNCHRONIZATION] is turned [ON], [NTP SYNCHRONIZATION] will return to [OFF]. Also if [NTP SYNCHRONIZATION] is turned [ON] while the NTP server is not set, [NTP SYNCHRONIZATION] will return to [OFF].
- Access the projector via a web browser to set the NTP server. Refer to "[Adjust clock] page" (➔ page 152) for details.
- If [ALL USER DATA] in the [PROJECTOR SETUP] menu → [INITIALIZE] (➔ page 126) is executed, [TIME ZONE] settings are reset to the factory defaults. However, the date and time based on the local date and time setting (Coordinated Universal Time, UTC, Universal Time, Coordinated) will be maintained without being initialized.

### [LENS CALIBRATION]

Detect the lens shift limit value of the projector and set the home position and the ET-DLE030 standard lens position automatically.

- 1) Press ▲▼ to select [LENS CALIBRATION].
- 2) Press ◀▶ to switch the item.
  - The items will switch each time you press the button.

<b>[NORMAL]</b>	Select this item when anything other than the fixed-focus lens (Model No.: ET-DLE030) is used. Move the lens to the home position after completing the calibration.
-----------------	---

[DLE030]

Select this item when the fixed-focus lens (Model No.: ET-DLE030) is used.  
Move the lens to the ET-DLE030 standard lens position after completing the calibration.

- 3) **Press the <ENTER> button.**
  - The confirmation screen is displayed.
- 4) **Press ◀▶ to select [OK], and press the <ENTER> button.**
  - To cancel, select [CANCEL].
  - The lens moves up, down, left, and right to automatically detect the lens shift limit value, and automatically set the home position and the ET-DLE030 standard lens position.
  - The lens stops to complete the calibration.

#### Note

- [PROGRESS] is displayed on the menu during lens calibration. Cannot cancel mid-operation.
- When lens calibration executes correctly, [COMPLETE] is displayed and [INCOMPLETE] is displayed when it does not execute correctly.

### [SAVE ALL USER DATA]

Save the various setting values as a backup in the built-in memory of the projector.

- 1) **Press ▲▼ to select [SAVE ALL USER DATA].**
- 2) **Press the <ENTER> button.**
  - The [SECURITY PASSWORD] screen is displayed.
- 3) **Enter a security password and press the <ENTER> button.**
- 4) **When the confirmation screen is displayed, press ◀▶ to select [OK], and press the <ENTER> button.**
  - [PROGRESS] is displayed while saving data.

#### Note

- Data set from the computer application is not included in [ALL USER DATA].

### [LOAD ALL USER DATA]

Load the various setting values saved as a backup in the built-in memory of the projector.

- 1) **Press ▲▼ to select [LOAD ALL USER DATA].**
- 2) **Press the <ENTER> button.**
  - The [SECURITY PASSWORD] screen is displayed.
- 3) **Enter a security password and press the <ENTER> button.**
- 4) **When the confirmation screen is displayed, press ◀▶ to select [OK], and press the <ENTER> button.**

#### Note

- The projector enters the standby mode to reflect the setting values when [LOAD ALL USER DATA] is executed.
- Data registered from a computer is not included in [ALL USER DATA].

### [INITIALIZE]

Return various setting values to their factory default settings.

- 1) **Press ▲▼ to select [INITIALIZE].**
- 2) **Press the <ENTER> button.**
  - The [SECURITY PASSWORD] screen is displayed.
- 3) **Enter a security password and press the <ENTER> button.**
  - The [INITIALIZE] screen is displayed.
- 4) **Press ▲▼ to select an item to initialize.**

[ALL USER DATA]

Returns all setting values including [REGISTERED SIGNAL], [NETWORK SETUP], [E-mail set up], and [USER LOGO] to the factory default settings.  
The projector enters the standby mode to reflect the setting values.

[REGISTERED SIGNAL]	Deletes all the setting values saved for each input signal. To delete only a part of a registered signal, perform the procedure described in “Deleting the registered signal” (➔ page 131).
[NETWORK/E-MAIL]	Returns [NETWORK SETUP] and [E-mail set up] to factory default settings.
[LOGO IMAGE]	Deletes the image registered in [USER LOGO].

5) Press the <ENTER> button.

6) When the confirmation screen is displayed, press ◀▶ to select [OK], and press the <ENTER> button.

**Note**

---

---

- Even when [ALL USER DATA] is executed, the [UNIFORMITY] and [STANDBY MODE] settings are not initialized.

**[SERVICE PASSWORD]**

---

This function is used by a service person.

## [P IN P] menu

On the menu screen, select [P IN P] from the main menu, and select an item from the sub-menu. Refer to “Navigating through the menu” (➔ page 71) for the operation of the menu screen.

- After selecting the item, press ▲▼◀▶ to set.

### Using P IN P function

Locate a separate, small sub screen in the main screen to project two images simultaneously.

- 1) Press ▲▼ to select [P IN P MODE].
- 2) Press the <ENTER> button.
  - The [P IN P MODE] screen is displayed.
- 3) Press ▲▼ to select a function.

[OFF]	P IN P function is not used.
[USER1]	The items set in “Setting P IN P function” (➔ page 128) are used in P IN P function.
[USER2]	
[USER3]	

- 4) Press the <ENTER> button.

### Setting P IN P function

P IN P function settings can be saved to [USER1], [USER2], and [USER3].

- 1) Press ▲▼ to select [P IN P MODE].
- 2) Press the <ENTER> button.
  - The [P IN P MODE] screen is displayed.
- 3) Press ▲▼ to select the desired mode from [USER1], [USER2], and [USER3], and press the <ENTER> button.
- 4) Press ▲▼ to select [MAIN WINDOW] or [SUB WINDOW], and press the <ENTER> button.
- 5) Press ▲▼ to select the input terminal to be displayed in the window, and press the <ENTER> button.
- 6) Press ▲▼ to select an item.

[SIZE]	Set the window display size between 10 % and 100 %.
[POSITION]	Set the display position of the window within the screen.
[CLOCK PHASE]	When the sub window is input from the <RGB 1 IN> terminal or the <RGB 2 IN> terminal and a flickering image or smeared outline appears, set between 0 and +31.

- 7) If [SIZE] is selected in Step 6), press the <ENTER> button.
  - The sub-menu is displayed.
- 8) Press ▲▼ to select an item.
- 9) Press ◀▶ to make adjustment, and press the <MENU> button.
- 10) If [POSITION] is selected in Step 6), press the <ENTER> button.
- 11) Press ▲▼◀▶ to adjust the position, and press the <MENU> button.
- 12) If [CLOCK PHASE] is selected in Step 6), press ◀▶ to make adjustment.
- 13) Press ▲▼ to select [FRAME LOCK].
- 14) Press ◀▶ to switch the item.

[SUB WINDOW]	Set frame lock to the input signal set in the sub window.
[MAIN WINDOW]	Set frame lock to the input signal set in the main window.



15) Press ▲▼ to select [TYPE].

16) Press ◀▶ to switch the item.

[SUB WINDOW]	The sub window has display priority.
[MAIN WINDOW]	The main window has display priority.

### Note

- The P IN P function may not be available for some signals being input or terminals being selected. Refer to “Two-window display combination list” (➔ page 185) for details.
- The main window setting values are applied to image adjustment values such as [PICTURE MODE], [GAMMA], and [COLOR TEMPERATURE].
- While in the normal screen (where no menu is displayed), press ◀▶ to switch the sizes and positions of the main window and sub window while P IN P is operating.
- When [FRAME RESPONSE] is set to other than [NORMAL], [P IN P] cannot be set.
- The combination of DIGITAL LINK and other input cannot be displayed in P IN P.
- When [BACKUP INPUT MODE] is set to [ON], [P IN P] cannot be set.

## [TEST PATTERN] menu

On the menu screen, select [TEST PATTERN] from the main menu.

Refer to “Navigating through the menu” (➔ page 71) for the operation of the menu screen.

- Press ◀▶ to switch.

### [TEST PATTERN]

Display the test pattern built-in to the projector.

Settings of position, size, and other factors will not be reflected in test patterns. Make sure to display the input signal before performing various adjustments.

#### 1) Press ◀▶ to switch the [TEST PATTERN] item.

- The items will switch each time you press the button.

Menu screen + All white	Displays test patterns with the menu screen. Select a test pattern so that it is easy to make various adjustments.
Menu screen + All black	
Menu screen + Window	
Menu screen + Window (inversion)	
Menu screen + Color bar (vertical)	
Menu screen + Color bar (horizontal)	
Menu screen + 16:9/4:3 aspect frame	
Menu screen + Focus	Displays the menu screen and input signal. Built-in test patterns are not displayed.
Menu screen + Entry screen	

#### Note

- Press the <ON SCREEN> button on the remote control while the test pattern is displayed to hide the menu screen.

#### Changing color or a focus test pattern

When the “Menu Screen + Focus” test pattern is displayed, the color can be changed.

- 1) Press ◀▶ to select the “Menu Screen + Focus” test pattern.
- 2) Press the <ENTER> button.
  - The [TEST PATTERN COLOR] screen is displayed.
- 3) Press ▲▼ to select a color, and press the <ENTER> button.
  - The test pattern color changed to the color selected.

#### Note

- The test pattern color settings return to [WHITE] when the projector is switched off.
- Colors of the test patterns other than focus test patterns cannot be changed.

## [SIGNAL LIST] menu

On the menu screen, select [SIGNAL LIST] from the main menu.

Refer to “Navigating through the menu” (➔ page 71) for the operation of the menu screen.

### ■ Registered signal details

Memory number: A1 (1-2)



When the signal of the address number (A1, A2, ...L7, L8) is registered

- A name can be set for each sub memory (➔ page 133).

### Registering new signals

After a new signal is input and the <MENU> button on the remote control or the control panel is pressed, the registration is completed and the [MAIN MENU] screen is displayed.

#### Note

- Up to 96 signals, including sub memories, can be registered to the projector.
- There are 12 pages (eight memories each for A through L, with eight memories possible on each page) for memory numbers, and the signal is registered to the lowest number that is available. If there is no available memory space, it will be overwritten from the oldest signal.
- The names to be registered are automatically determined by the input signals and memory numbers.
- If a menu is being displayed, the new signals will be registered at the instant they are input.

### Renaming the registered signal

Registered signals can be renamed.

- 1) Press **▲▼◀▶** to select the signal of which name is to be changed.
- 2) Press the <ENTER> button.
  - The [REGISTERED SIGNAL STATUS] screen is displayed.
  - The memory number, input terminal, input signal name, frequency, synch polarity, etc., are displayed.
  - Press the <MENU> button to return to the [SIGNAL LIST] screen.
- 3) Press the <ENTER> button.
  - The [REGISTERED SIGNAL SETUP] screen is displayed.
- 4) Press **▲▼** to select [SIGNAL NAME CHANGE].
- 5) Press the <ENTER> button.
  - The [SIGNAL NAME CHANGE] screen is displayed.
- 6) Press **▲▼◀▶** to select the text, and press the <ENTER> button to enter the text.
- 7) After the name is changed, press **▲▼◀▶** to select [OK], and press the <ENTER> button.
  - The registration is completed and the [REGISTERED SIGNAL SETUP] screen returns.
  - When pressing **▲▼◀▶** to select [CANCEL] and pressing the <ENTER> button, the changed signal name will not be registered and an automatically registered signal name will be used.

### Deleting the registered signal

Registered signals can be deleted.

- 1) Press **▲▼◀▶** to select the signal to delete.
- 2) Press the <DEFAULT> button on the remote control.
  - The [REGISTERED SIGNAL DELETE] screen is displayed.
  - To cancel the deletion, press the <MENU> button to return to the [REGISTERED SIGNAL LIST] screen.
- 3) Press the <ENTER> button.
  - The selected signal will be deleted.

**Note**

- A registered signal can also be deleted from [REGISTERED SIGNAL DELETE] on the [REGISTERED SIGNAL SETUP] screen.

**Protecting the registered signal**

- 1) Press **▲▼◀▶** to select the signal to protect.
- 2) Press the **<ENTER>** button.
  - The [REGISTERED SIGNAL STATUS] screen is displayed.
- 3) Press the **<ENTER>** button.
  - The [REGISTERED SIGNAL SETUP] screen is displayed.
- 4) Press **▲▼** to select [LOCK].
- 5) Press **◀▶** to switch the item.
  - The items will switch each time you press the button.

[OFF]	The signal is not protected.
[ON]	The signal is protected.

**Note**

- When [LOCK] is set to [ON], signal deletion, image adjustment, and automatic setup are not available. To perform these operations, set [LOCK] to [OFF].
- A signal can be registered to the sub memory even if it is protected.
- Even a protected signal will be deleted if [INITIALIZE] is executed.

**Expanding signal lock-in range**

- 1) Press **▲▼◀▶** to select the signal to set.
- 2) Press the **<ENTER>** button.
  - The [REGISTERED SIGNAL STATUS] screen is displayed.
- 3) Press the **<ENTER>** button.
  - The [REGISTERED SIGNAL SETUP] screen is displayed.
- 4) Press **▲▼** to select [LOCK-IN RANGE].
- 5) Press **◀▶** to switch the item.
  - The items will switch each time you press the button.

[NARROW]	Select this item usually.
[WIDE]	Widens the lock-in range.

**Note**

- Switch the range that determines that a signal to be input is the same signal that is already registered.
- To prioritize the determination that it is the same signal that is already registered, set to the [WIDE] setting.
- Use in cases such as when the synchronizing frequency of a signal to be input has changed slightly, or multiple signal lists are registered.
- Available only when a signal is input from the <RGB 1 IN> terminal, <RGB 2 IN> terminal, <DVI-D IN> terminal, <HDMI IN> terminal, or <DIGITAL LINK/LAN> terminal.
- When [WIDE] is set, the image may be distorted because a signal is recognized as the same even if its synchronizing frequency varies slightly.
- When a signal to be input corresponds to multiple signals set in [WIDE], a registered signal with a larger memory number receives priority. Example: a signal to be input that corresponds to memory numbers A2, A4, and B1 will be determined to be B1.
- When a registration signal is deleted, the settings are also deleted.
- In an environment where multiple types of signals are input to the same terminal, signals are sometimes not determined correctly when the setting is set to [WIDE].

## Sub memory

The projector has a sub memory function that can register the multiple image adjustment data, even if it is recognized as the same signal by the frequency or format of the synchronization signal source.

Use this function when you need to adjust the picture quality such as switching of the aspect ratio or white balance by the same synchronization signal source. The sub memory includes all the data that can be adjusted for each signal, such as the image aspect ratio and data adjusted in the [PICTURE] item ([CONTRAST], [BRIGHTNESS], etc.).

### Registering to the sub memory

- 1) Press ◀▶ on the normal screen (when the menu is not displayed).
  - The sub memory registration screen is displayed if the sub memory is not registered. Proceed to Step 3).
  - A list of sub memories registered to the signal currently input is displayed.
  - By selecting [SUB MEMORY] from the [PROJECTOR SETUP] menu → [FUNCTION BUTTON], the <FUNCTION> button on the remote control can be used instead of ◀▶.
- 2) Press ▲▼◀▶ to select the sub memory number to register in [SUB MEMORY LIST].
- 3) Press the <ENTER> button.
  - The [SIGNAL NAME CHANGE] screen is displayed.
- 4) Press ▲▼◀▶ to select [OK], and press the <ENTER> button.
  - To rename the registered signal, follow the procedure in Steps 6) and 7) in “Renaming the registered signal” (➔ page 131).

### Switching to the sub memory

- 1) Press ◀▶ on the normal screen (when the menu is not displayed).
  - A list of sub memories registered to the signal currently input is displayed.
- 2) Press ▲▼◀▶ to select the signal to switch in [SUB MEMORY LIST].
- 3) Press the <ENTER> button.
  - This switches to the signal selected in Step 2).

### Deleting the sub memory

- 1) Press ◀▶ on the normal screen (when the menu is not displayed).
  - The [SUB MEMORY LIST] screen is displayed.
- 2) Press ▲▼◀▶ to select the sub memory to be deleted, and press the <DEFAULT> button on the remote control.
  - The [REGISTERED SIGNAL DELETE] screen is displayed.
  - To cancel the deletion, press the <MENU> button to return to the [SUB MEMORY LIST] screen.
- 3) Press the <ENTER> button.
  - The selected sub memory will be deleted.

## [SECURITY] menu

On the menu screen, select [SECURITY] from the main menu, and select an item from the sub-menu. Refer to “Navigating through the menu” (➔ page 71) for the operation of the menu screen.

- When the projector is used for the first time  
Initial password: Press ▲▶▼◀▲▶▼◀ in order, and press the <ENTER> button.
- After selecting the item, press ▲▼◀▶ to set.

### Attention

- When you select the [SECURITY] menu and press the <ENTER> button, entering a password is required. Enter the preset password and then continue operations of the [SECURITY] menu.
- When the password has been changed previously, enter the changed password, and press the <ENTER> button.

### Note

- The entered password is displayed with \*marks on the screen.
- An error message is displayed on the screen when the entered password is incorrect. Re-enter the correct password.

## [SECURITY PASSWORD]

Display the [SECURITY PASSWORD] screen when the power is turned on with the <MAIN POWER> switch set to the <OFF> side. When the entered password is incorrect, the operation will be restricted to the power standby <⏻> button, the <SHUTTER> button, and the <LENS> (<FOCUS>, <ZOOM>, <SHIFT>) buttons.

- 1) Press ▲▼ to select [SECURITY PASSWORD].
- 2) Press ◀▶ to switch the item.
  - The items will switch each time you press the button.

[OFF]	Disables the security password entry.
[ON]	Enables the security password entry.

### Note

- The [SECURITY PASSWORD] setting is set to [OFF] by the factory default or when [ALL USER DATA] in [INITIALIZE] (➔ page 126) is executed.
- Change the password periodically that is hard to guess.
- The security password is enabled after setting [SECURITY PASSWORD] to [ON] and turning the <MAIN POWER> switch to <OFF>.

## [SECURITY PASSWORD CHANGE]

Change the security password.

- 1) Press ▲▼ to select [SECURITY PASSWORD CHANGE].
- 2) Press the <ENTER> button.
  - The [SECURITY PASSWORD CHANGE] screen is displayed.
- 3) Press ▲▼◀▶ and the number (<0> - <9>) buttons to set the password.
  - Up to eight button operations can be set.
- 4) Press the <ENTER> button.
- 5) Re-enter the password for the confirmation.
- 6) Press the <ENTER> button.

### Note

- The entered password is displayed with \*marks on the screen.
- When numerical values are used for the security password, the security password is required to be initialized if the remote control is lost. Consult your dealer for the method of initialization.

## [DISPLAY SETTING]

Overlap the security message (text or image) over the projecting image.

- 1) Press ▲▼ to select [DISPLAY SETTING].

2) Press ◀▶ to switch the item.

- The items will switch each time you press the button.

[OFF]	Hides the security message.
[TEXT]	Displays the text set in the [SECURITY] menu → [TEXT CHANGE].
[USER LOGO]	Displays the image registered by the user.

**Note**

- To create/register the [USER LOGO] image, use “Logo Transfer Software” included in the supplied CD-ROM.

**[TEXT CHANGE]**

Edit the text to be displayed when [TEXT] is selected in [DISPLAY SETTING].

- 1) Press ▲▼ to select [TEXT CHANGE].
- 2) Press the <ENTER> button.
  - The [TEXT CHANGE] screen is displayed.
- 3) Press ▲▼◀▶ to select the text, and press the <ENTER> button to enter the text.
- 4) Press ▲▼◀▶ to select [OK], and press the <ENTER> button.
  - The text is changed.

**[CONTROL DEVICE SETUP]**

Enable/disable the button operations on the control panel and the remote control.

- 1) Press ▲▼ to select [CONTROL DEVICE SETUP].
- 2) Press the <ENTER> button.
  - The [CONTROL DEVICE SETUP] screen is displayed.
- 3) Press ▲▼ to select [CONTROL PANEL] or [REMOTE CONTROL].

[CONTROL PANEL]	You can set the limitation on the control from the control panel.
[REMOTE CONTROL]	You can set the limitation on the control from the remote control.

- 4) Press the <ENTER> button.
  - The [CONTROL PANEL] screen or the [REMOTE CONTROL] screen is displayed.
- 5) Press ▲▼ to select [CONTROL PANEL] or [REMOTE CONTROL].
- 6) Press ◀▶ to switch the item.
  - You can set the operation restriction from the control panel or the remote control.

[ENABLE]	Enables all button operations.
[DISABLE]	Disables all button operations.
[USER]	Operation of all buttons can be enabled/disabled separately. Refer to “Enabling/disabling any button” (➔ page 135) for details.

- 7) Press ▲▼ to select [APPLY], and press the <ENTER> button.
  - The confirmation screen is displayed.
- 8) Press ◀▶ to select [OK], and press the <ENTER> button.

**Enabling/disabling any button**

- 1) Press ▲▼ to select [CONTROL DEVICE SETUP].
- 2) Press the <ENTER> button.
  - The [CONTROL DEVICE SETUP] screen is displayed.
- 3) Press ▲▼ to select [CONTROL PANEL] or [REMOTE CONTROL].

- 4) Press the <ENTER> button.
- 5) Press ▲▼ to select [CONTROL PANEL] or [REMOTE CONTROL].
- 6) Press ◀▶ to switch [USER].
- 7) Press ▲▼ to select the button item to set.
  - When [INPUT SELECT BUTTON] is selected, press the <ENTER> button, and then press ▲▼ to select the button to set.

	Buttons that can be set	
	[CONTROL PANEL]	[REMOTE CONTROL]
[POWER BUTTON]	Power standby <⏻> button, power on < > button	
[INPUT SELECT BUTTON]	<RGB1> button, <RGB2> button, <DVI-D> button, <HDMI> button, <DIGITAL LINK> button, <SDI> button*1	<VIDEO> button, <RGB1/2> button, <DVI-D> button, <HDMI> button, <DIGITAL LINK> button, <SDI> button*1
[MENU BUTTON]	<MENU> button	
[LENS BUTTON]	<LENS> button	Lens (<FOCUS>, <ZOOM>, <SHIFT>) button
[AUTO SETUP BUTTON]	<AUTO SETUP> button	
[SHUTTER BUTTON]	<SHUTTER> button	
[ON SCREEN BUTTON]	—	<ON SCREEN> button
[OTHER BUTTON]	▲▼◀▶, <ENTER> button	Buttons not listed above

\*1 SDI input is supported only for PT-DZ780.

- 8) Press ◀▶ to switch the item.

[ENABLE]	Enables button operations.
[DISABLE]	Disables button operations.

- The following items are available only when [RGB1/2 BUTTON] of [INPUT SELECT BUTTON] is selected.

[TOGGLE]	Switches between [RGB1] and [RGB2] when the button is operated.
[RGB1]	Fixes to [RGB1].
[RGB2]	Fixes to [RGB2].
[DISABLE]	Disables button operations.

- The following items are available only when [VIDEO BUTTON] of [INPUT SELECT BUTTON] is selected.

[DISABLE]	Disables button operations.
[VIDEO]	Fixes to [VIDEO].
[Y/C]	Fixes to [Y/C].
[TOGGLE]	Switches between [VIDEO] and [Y/C] when the button is operated.

- When [INPUT SELECT BUTTON] is selected in Step 7), after the item is switched, press the <MENU> button to return to the [CONTROL PANEL] screen or the [REMOTE CONTROL] screen.

- 9) Press ▲▼ to select [APPLY], and press the <ENTER> button.

- The confirmation screen is displayed.

- 10) Press ◀▶ to select [OK], and press the <ENTER> button.

### Note

- When a button operation is performed on the device set to [DISABLE], the [CONTROL DEVICE PASSWORD] screen is displayed. Enter the control device password.
- The [CONTROL DEVICE PASSWORD] screen will disappear when there is no operation for approx. 10 seconds.
- If the operations of both [CONTROL PANEL] and [REMOTE CONTROL] are set to [DISABLE], the projector cannot be turned off (cannot enter standby).
- When the setting has completed, the menu screen will disappear. To operate continuously, press the <MENU> button to display the main menu.
- Even when button operation on the remote control is disabled, operation of the <ID SET> button on the remote control is enabled.

## [CONTROL DEVICE PASSWORD CHANGE]

The control device password can be changed.

- 1) Press ▲▼ to select [CONTROL DEVICE PASSWORD CHANGE].



- 2) Press the <ENTER> button.
  - The [CONTROL DEVICE PASSWORD CHANGE] screen is displayed.
- 3) Press ▲▼◀▶ to select the text, and press the <ENTER> button to enter the text.
- 4) Press ▲▼◀▶ to select [OK], and press the <ENTER> button.
  - To cancel, select [CANCEL].

---

**Attention**

---

- The initial password is "AAAA" by the factory default or when [ALL USER DATA] in [INITIALIZE] (➡ page 126) is executed.
- Change the password periodically that is hard to guess.

## [NETWORK] menu

On the menu screen, select [NETWORK] from the main menu, and select an item from the sub-menu. Refer to “Navigating through the menu” (➔ page 71) for the operation of the menu screen.

- After selecting the item, press ▲▼◀▶ to set.

### [DIGITAL LINK MODE]

Switch the communication method of the <DIGITAL LINK/LAN> terminal of the projector.

- 1) Press ▲▼ to select [DIGITAL LINK MODE].
- 2) Press ◀▶ to switch the item.
  - The items will switch each time you press the button.

[AUTO]	Switches the communication method automatically to DIGITAL LINK, long reach, or Ethernet.
[DIGITAL LINK]	Fixes the communication method to DIGITAL LINK.
[LONG REACH]	Fixes the communication method to long reach.
[ETHERNET]	Fixes the communication method to Ethernet.

### Possible communication modes

✓: Communication possible

—: Communication not possible

Setting		Communication possible			
		Video transfer (100 m (328'1"))	Video transfer (150 m (492'2"))	Ethernet	RS-232C
[AUTO]	For DIGITAL LINK	✓	—	✓	✓
	For long reach	—	✓	✓	✓
	For Ethernet	—	—	✓	—
[DIGITAL LINK]		✓	—	✓	✓
[LONG REACH]		—	✓	✓	✓
[ETHERNET]		—	—	✓	—

### Note

- The maximum transmission distance when connected with the long-reach communication method is 150 m (492'2"). However, the signal that the projector can receive is only up to 1080/60p (148.5 MHz).
- When the communication method of the twist-pair-cable transmitter is set to long reach, it will connect with long-reach communication method when [DIGITAL LINK MODE] is set to [AUTO]. To connect with the optional DIGITAL LINK Switcher (Model No.: ET-YFB200G) with the long-reach communication method, set [DIGITAL LINK MODE] to [LONG REACH].
- It will not connect correctly if the twist-pair-cable transmitter is not supporting the long-reach communication method even if [DIGITAL LINK MODE] is set to [LONG REACH].

### [DIGITAL LINK SETUP]

Set the communication method of DIGITAL LINK or Ethernet.

#### When the projector is connected directly via Ethernet

- 1) Press ▲▼ to select [DIGITAL LINK SETUP].
- 2) Press the <ENTER> button.
  - The [DIGITAL LINK SETUP] screen is displayed.
- 3) Press ▲▼ to select [DUPLEX(ETHERNET)].
- 4) Press ◀▶ to switch the communication method.
  - The items will switch each time you press the button.

[AUTONEGOTIATION]	Sets the communication method automatically.
[100BaseTX-Full]	Full-duplex communication method is set.
[100BaseTX-Half]	Half-duplex communication method is set.

- 5) Press ▲▼ to select [STORE].
- 6) Press the <ENTER> button.
- 7) When the confirmation screen is displayed, press ◀▶ to select [OK], and press the <ENTER> button.

**Note**

- The projector does not support 10BaseT Full/Half.

**When the projector is connected to a twisted-pair-cable transmitter**

- 1) Press ▲▼ to select [DIGITAL LINK SETUP].
- 2) Press the <ENTER> button.
  - The [DIGITAL LINK SETUP] screen is displayed.
- 3) Press ▲▼ to select [DUPLEX(DIGITAL LINK)].
- 4) Press ◀▶ to switch the communication method.
  - The items will switch each time you press the button.

[100BaseTX-Full]	Full-duplex communication method is set.
[100BaseTX-Half]	Half-duplex communication method is set.
[AUTONEGOTIATION]	Sets the communication method automatically.

- 5) Press ▲▼ to select [STORE].
- 6) Press the <ENTER> button.
- 7) When the confirmation screen is displayed, press ◀▶ to select [OK], and press the <ENTER> button.

**[DIGITAL LINK STATUS]**

Display the DIGITAL LINK connection environment.

- 1) Press ▲▼ to select [DIGITAL LINK STATUS].
- 2) Press the <ENTER> button.
  - The [DIGITAL LINK STATUS] screen is displayed.

[LINK STATUS]	Either [NO LINK], [DIGITAL LINK], [LONG REACH], or [ETHERNET] is displayed.
[HDCP STATUS]	Either [NO SIGNAL], [OFF], or [ON] is displayed.
[SIGNAL QUALITY]	<p>[SIGNAL QUALITY] is a numerical value of the amount of error, and the display color changes to green, yellow, or red depending on that value. Check the signal quality level while receiving a signal from the twisted-pair-cable transmitter.</p> <ul style="list-style-type: none"> <li>• [MAX]/[MIN]: Maximum/minimum value of the amount of error</li> <li>• Green (-12 dB or lower) → Normal signal quality level</li> <li>• Yellow (-11 to -8 dB) → Warning level where there is the possibility of noise introduced on the screen</li> <li>• Red (-7 dB or higher) → Abnormal level where synchronization may be interrupted, or a signal may not be received</li> </ul>

**[NETWORK SETUP]**

Perform the initial setting of the network before using the network function.

- 1) Press ▲▼ to select [NETWORK SETUP].
- 2) Press the <ENTER> button.
  - The [NETWORK SETUP] screen is displayed.
- 3) Press ▲▼ to select an item, and change the settings according to the operation instructions of the menu.

[PROJECTOR NAME]	Allows to change the projector name. Enter the host name if it is required in such a case when you use a DHCP server.
------------------	---

[DHCP]	[ON]	If a DHCP server exists in the network where the projector is to be connected, obtains the IP address automatically.
	[OFF]	If a DHCP server does not exist in the network where the projector is to be connected, set [IP ADDRESS], [SUBNET MASK], and [DEFAULT GATEWAY].
[IP ADDRESS]	Enter the IP address when you do not use a DHCP server.	
[SUBNET MASK]	Enter the subnet mask when you do not use a DHCP server.	
[DEFAULT GATEWAY]	Enter the default gateway address when you do not use a DHCP server.	
[STORE]	Save the current network settings.	

- 4) Press ▲▼ to select [STORE], and press the <ENTER> button.
- 5) When the confirmation screen is displayed, press ◀▶ to select [OK], and press the <ENTER> button.

**Note**

- When using a DHCP server, confirm that the DHCP server is running.
- Consult your network administrator regarding the IP address, subnet mask, and default gateway.
- When [Art-Net SETUP] is set to [ON(2.X.X.X)] or [ON(10.X.X.X)], [NETWORK SETUP] cannot be selected.

**[NETWORK CONTROL]**

Set up the control method of the network.

- 1) Press ▲▼ to select [NETWORK CONTROL].
- 2) Press the <ENTER> button.
  - The [NETWORK CONTROL] screen is displayed.
- 3) Press ▲▼ to select an item, and press ◀▶ to change the setting.

[WEB CONTROL]	Set to [ON] to control with the web browser.
[PJLink CONTROL]	Set to [ON] to control with the PJLink protocol.
[COMMAND CONTROL]	Set to [ON] to control with the <SERIAL IN>/<SERIAL OUT> terminal control command format (➔ page 183). Refer to “Control commands via LAN” (➔ page 177).
[COMMAND PORT]	Set the port number used for command control.
[Crestron Connected(TM)]	Set to [ON] to control with Crestron Connected™ of Crestron Electronics, Inc.
[AMX D.D.]	Set to [ON] to control with the controller of AMX Corporation. Setting this function to [ON] enables detection through “AMX Device Discovery”. For details, refer to the website of AMX Corporation. URL <a href="http://www.amx.com/">http://www.amx.com/</a>
[EXTRON XTP]	Set to [ON] when connecting the “XTP transmitter” of Extron Electronics to the <DIGITAL LINK/LAN> terminal. The [EXTRON XTP] setting must be set to [OFF] when connecting the optional DIGITAL LINK output supported device (Model No.: ET-YFB100G, ET-YFB200G). For details of the “XTP transmitter”, refer to the website of Extron Electronics. URL <a href="http://www.extron.com/">http://www.extron.com/</a>
[STORE]	Save the current network control settings.

- 4) Press ▲▼ to select [STORE], and press the <ENTER> button.
- 5) When the confirmation screen is displayed, press ◀▶ to select [OK], and press the <ENTER> button.

**[NETWORK STATUS]**

Display the status of the projector network.

- 1) Press ▲▼ to select [NETWORK STATUS].
- 2) Press the <ENTER> button.
  - The [NETWORK STATUS] screen is displayed.

[DHCP]	Displays the status of use of the DHCP server.
[IP ADDRESS]	Displays the [IP ADDRESS].
[SUBNET MASK]	Displays the [SUBNET MASK].
[DEFAULT GATEWAY]	Displays the [DEFAULT GATEWAY].
[DNS1]	Displays the address of the primary DNS server.

[DNS2]	Displays the address of the secondary DNS server.
[MAC ADDRESS]	Displays the [MAC ADDRESS].

## [DIGITAL LINK MENU]

When the optional DIGITAL LINK output supported device (Model No.: ET-YFB100G, ET-YFB200G) is connected to the <DIGITAL LINK/LAN> terminal, the main menu of DIGITAL LINK output supported device is displayed. Refer to the Operating Instructions of the DIGITAL LINK output supported device for details.

### Note

- When [EXTRON XTP] is set to [ON], [DIGITAL LINK MENU] cannot be selected.
- The operation guidance for the "RETURN" button is displayed on the menu screen of the Digital Interface Box and DIGITAL LINK Switcher. The projector does not have the "RETURN" button, but same operation is available with the <MENU> button.

## [Art-Net SETUP]

Make settings to use the Art-Net function. For the channel definitions used for controlling the projector with the Art-Net function, refer to "Using Art-Net function" (➔ page 175).

- 1) Press ▲▼ to select [Art-Net SETUP].
- 2) Press ◀▶ to select an item.
  - The items will switch each time you press the button.

[OFF]	Disables the Art-Net function.
[ON(2.X.X.X)]	Enables the Art-Net function and sets the IP address to 2.X.X.X.
[ON(10.X.X.X)]	Enables the Art-Net function and sets the IP address to 10.X.X.X.
[ON(MANUAL)]	Enables the Art-Net function and uses the IP address set in [NETWORK SETUP].

- When other than [OFF] is selected, proceed to Step 3).

- 3) Press the <ENTER> button.
  - The [Art-Net SETUP] screen is displayed.
- 4) Press ▲▼ to select [CHANNEL SETUP].
- 5) Press ◀▶ to switch the item.

[DEFAULT]	Uses the channel assignment with the standard setting for the projector.
[USER]	Uses to change the channel assignment.
[DZ870/DZ21K]	Uses the channel assignment with DZ870 series and DZ21K series compatible. DZ870 series: DZ870 series, DW830 series, DX100 series DZ21K series: DZ21K series, DS20K series, DW17K series, DZ16K series

- When [DEFAULT] or [DZ870/DZ21K] is selected, pressing the <ENTER> button displays the function assigned to the channel.
- When [DEFAULT] or [DZ870/DZ21K] is selected, proceed to Step 9).

- 6) Press the <ENTER> button.
  - The [CHANNEL SETUP] screen is displayed.
- 7) Press ▲▼ to select the channel to set, and press ◀▶ to switch the item.

[LIGHT OUTPUT]	Adjusts the amount of light.
[INPUT SELECT]	Switches the input.
[LENS POSITION]	Moves the lens position.
[LENS H SHIFT]	Adjusts the lens shift in the horizontal direction.
[LENS V SHIFT]	Adjusts the lens shift in the vertical direction.
[LENS FOCUS]	Adjusts the focus.
[LENS ZOOM]	Adjusts the zoom.
[POWER]	Controls the power status.
[SHUTTER]	Controls the shutter.
[GEOMETRY]	Performs geometric adjustment.
[CUSTOM MASKING]*1	Performs geometric adjustment using the computer. To use PC-1, PC-2, and PC-3, the optional Upgrade Kit (Model No.: ET-UK20) is required.

[FREEZE]	Freezes the projected image.
[COLOR]	Adjusts the color saturation.
[TINT]	Adjusts the tint.
[RASTER PATTERN]	Displays the raster pattern.
[ENABLE / DISABLE]	Enables/disables the control of the projector with the Art-Net function.
[NONE]	No definition

\*1 Only for PT-DZ780

- The settings can be made by pressing ▲▼ to select the channel to set and pressing the <ENTER> button to display the item list, and pressing ▲▼ to select an item, and then pressing the <ENTER> button.
- Same item cannot be set for multiple channels, except for [NONE].

8) Press the <MENU> button.

- The [Art-Net SETUP] screen is displayed.

9) Press ▲▼ to select an item, and press ◀▶ to switch the settings.

[NET]	Enter [NET] to be used when the projector processes Art-Net.
[SUB NET]	Enter [SUB NET] to be used when the projector processes Art-Net.
[UNIVERSE]	Enter [UNIVERSE] to be used when the projector processes Art-Net.
[START ADDRESS]	Enter [START ADDRESS] to be used when the projector processes Art-Net.

10) Press ▲▼ to select [STORE], and press the <ENTER> button.

11) When the confirmation screen is displayed, press ◀▶ to select [OK], and press the <ENTER> button.

**Note**

- If [ON(2.X.X.X)] or [ON(10.X.X.X)] is selected, IP address is calculated and set automatically.

**Network connection**

The projector has a network function, and the following operations are available from the computer using the web control.

- Setting and adjustment of the projector
- Display of the projector status
- Sending E-mail messages when there is a problem with the projector

The projector supports “Crestron Connected™”, and the following application software of Crestron Electronics, Inc. can be used.

- RoomView Express
- Fusion RV
- RoomView Server Edition

**Attention**

- When a LAN cable is directly connected to the projector, the network connection must be made indoors.

**Note**

- “Crestron Connected™” is a system of Crestron Electronics, Inc. that collectively manages and controls devices on multiple systems connected to the network using a computer.
- For details of “Crestron Connected™”, refer to the website of Crestron Electronics, Inc. (English only)  
URL <http://www.crestron.com>  
To download “RoomView Express”, go to the following website of Crestron Electronics, Inc. (English only)  
URL <http://www.crestron.com/getroomview>
- A LAN cable is required to use the network function.

■ Example of a normal network connection

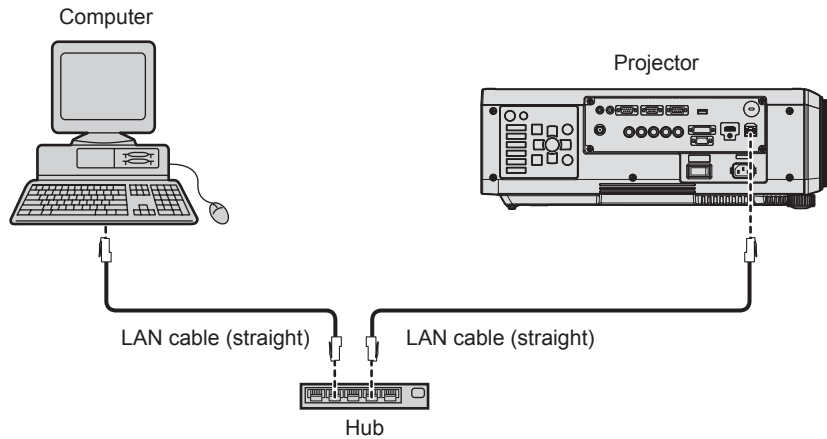

- A web browser is required to use network function. Confirm that the web browser can be used beforehand.  
Compatible browser: Internet Explorer 8.0/9.0/10.0/11.0 (Windows OS), Safari 6.0/7.0/8.0 (Mac OS)
- Communication with an E-mail server is required to use the E-mail function. Confirm that the E-mail can be used beforehand.
- Use a LAN cable that is compatible with category 5 or higher.
- Use a LAN cable of 100 m (328'1") or shorter.

**Connecting to a twisted-pair-cable transmitter**

The projector has a function that can receive Ethernet signals from a twisted-pair-cable transmitter together with video and audio signals via a LAN cable. Connect a LAN cable to the <DIGITAL LINK/LAN> terminal of the projector. (➔ pages 20, 27)

■ Example of network connections via a twisted-pair-cable transmitter

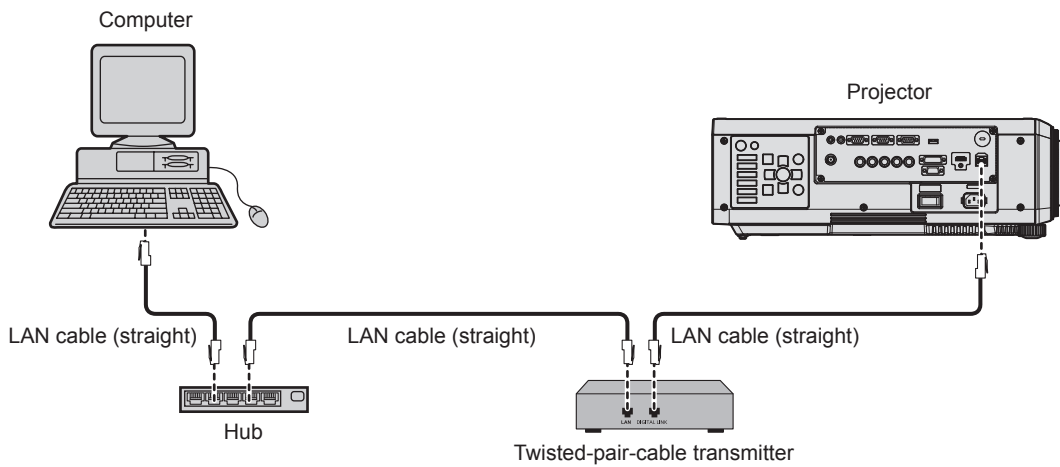

- For the LAN cable between the twisted-pair-cable transmitter and the projector, use a cable that meets the following criteria:
  - Compatible with CAT5e or higher
  - Shielded type (including connectors)
  - Straight-through
  - Single wire
- The maximum transmission distance between the twisted-pair-cable transmitter and the projector is 100 m (328'1"). It is possible to transmit up to 150 m (492'2") if the twisted-pair-cable transmitter supports the long-reach communication method. If this distance is exceeded, image may be disrupted or a malfunction may occur in LAN communication.
- When laying cables between the twisted-pair-cable transmitter and the projector, check that cable characteristics are compatible with CAT5e or higher using tools such as a cable tester or cable analyzer.  
When a relay connector is used, include it in the measurement.
- Do not use a hub between the twisted-pair-cable transmitter and the projector.
- Do not pull cables forcefully. In addition, do not bend or fold cables unnecessarily.
- To reduce the effects of noise as much as possible, stretch out the cables between the twisted-pair-cable transmitter and the projector without any loops.
- Lay the cables between a twisted-pair-cable transmitter and the projector away from other cables, particularly power cables.
- When laying multiple cables, run them side by side along the shortest distance possible without bundling them together.
- After laying the cables, confirm that the value of [SIGNAL QUALITY] in the [NETWORK] menu → [DIGITAL LINK STATUS] is displayed in green to indicate normal quality. (➔ page 139)
- For twisted-pair-cable transmitters of other manufacturers of which the operation has been verified with the projector, refer to the Panasonic website (<http://panasonic.net/avc/projector/>). Note that the verification for devices of other manufacturers has been made for the items set by Panasonic Corporation, and not all the operations have been verified. For operation or performance problems caused by the devices of other manufacturers, contact the respective manufacturers.

## Accessing from the web browser

- 1) Start up the web browser on the computer.
- 2) Enter the IP address set on the projector into the URL entry field of the web browser.
- 3) Enter the user name and the password.
  - The factory default setting of the user name is user1 (user rights)/admin1 (administrator rights) and the password is panasonic (lower case).

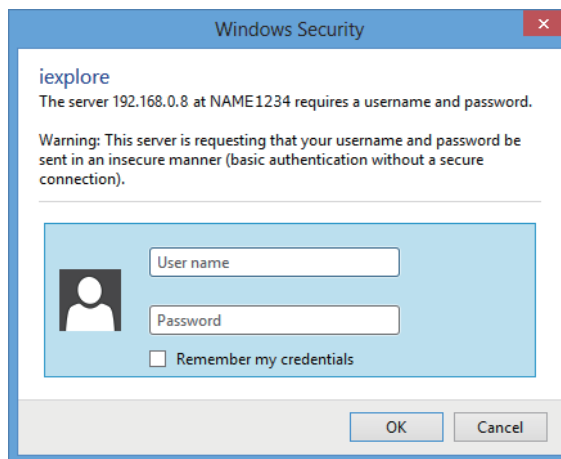



4) Click OK.

- The [Projector status] page is displayed.

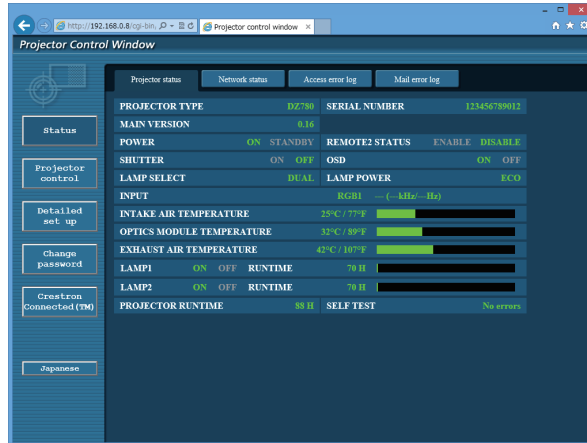

**Note**

- If you use a web browser to control the projector, set [WEB CONTROL] to [ON] in [NETWORK CONTROL] (➔ page 140).
- Do not perform setting or control simultaneously by starting up multiple web browsers. Do not set or control the projector from multiple computers.
- Change the password first. (➔ page 157)
- The administrator rights allow use of all functions. The user rights allow use of [Projector status] (➔ page 146), confirmation of the error information page (➔ page 147), [Network status] (➔ page 148), [Basic control] (➔ page 150), and [Change password] (➔ page 157) only.
- Access will be locked for few minutes when an incorrect password is entered three times consecutively.
- Some items on the projector setting page use the Javascript function of the web browser. The projector may not be able to be controlled properly if this function is disabled on the browser settings.
- If the screen for the web control is not displayed, consult your network administrator.
- While updating the screen for the web control, the screen may appear white for a moment, but it is not a malfunction.

**Descriptions of items**

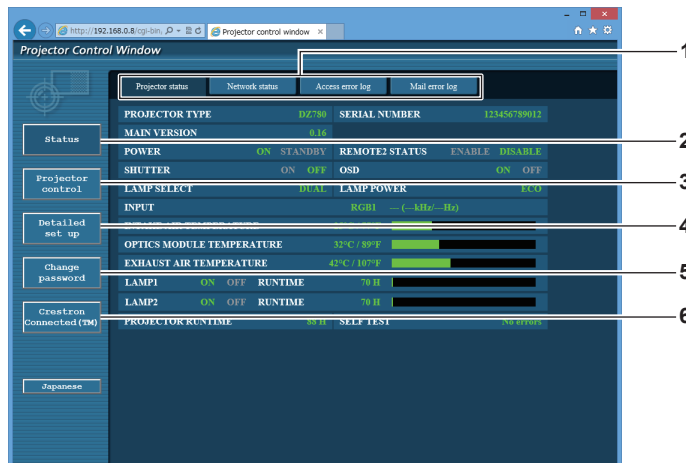

- |  |  |
|--|--|
| <p><b>1 Page tab</b><br/>Switches pages by clicking this item.</p> <p><b>2 [Status]</b><br/>The status of the projector is displayed by clicking this item.</p> <p><b>3 [Projector control]</b><br/>The [Projector control] page is displayed by clicking this item.</p> | <p><b>4 [Detailed set up]</b><br/>The [Detailed set up] page is displayed by clicking this item.</p> <p><b>5 [Change password]</b><br/>The [Change password] page is displayed by clicking this item.</p> <p><b>6 [Crestron Connected(TM)]</b><br/>The operation page of Crestron Connected™ is displayed by clicking this item.</p> |
|--|--|

[Projector status] page

Click [Status] → [Projector status].

Display the status of the projector for the following items.

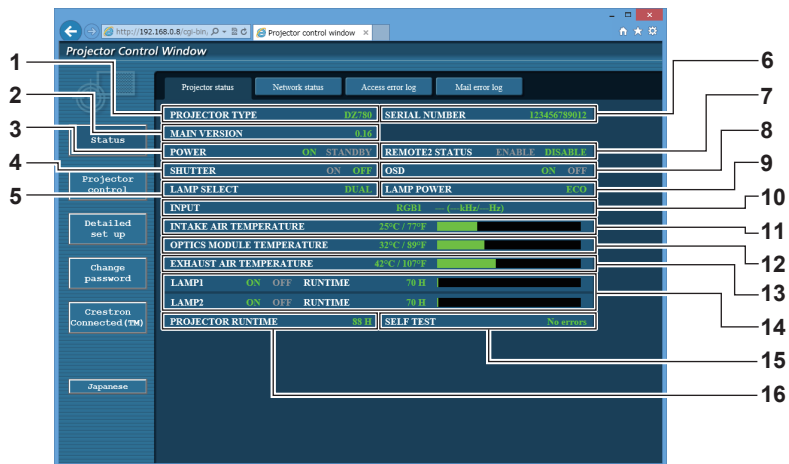

- |   |   |
|---|---|
| <p>1 <b>[PROJECTOR TYPE]</b><br/>Displays the type of the projector.</p> <p>2 <b>[MAIN VERSION]</b><br/>Displays the firmware version of the projector.</p> <p>3 <b>[POWER]</b><br/>Displays the status of the power.</p> <p>4 <b>[SHUTTER]</b><br/>Displays the status of shutter function (ON: enabled (closed), OFF: disabled (open)).</p> <p>5 <b>[LAMP SELECT]</b><br/>Displays the setting status of [LAMP SELECT] (➡ page 112).</p> <p>6 <b>[SERIAL NUMBER]</b><br/>Displays the serial number of the projector.</p> <p>7 <b>[REMOTE2 STATUS]</b><br/>Displays the control status of the &lt;REMOTE 2 IN&gt; terminal.</p> <p>8 <b>[OSD]</b><br/>Displays the status of the on-screen display.</p> | <p>9 <b>[LAMP POWER]</b><br/>Displays the setting status of [LAMP POWER] (➡ page 113).</p> <p>10 <b>[INPUT]</b><br/>Displays the status of the selected input.</p> <p>11 <b>[INTAKE AIR TEMPERATURE]</b><br/>Displays the status of the intake air temperature of the projector.</p> <p>12 <b>[OPTICS MODULE TEMPERATURE]</b><br/>Displays the status of the internal temperature of the projector.</p> <p>13 <b>[EXHAUST AIR TEMPERATURE]</b><br/>Displays the status of the exhaust air temperature of the projector.</p> <p>14 <b>[LAMP1], [LAMP2], [RUNTIME]</b><br/>Displays the lighting status and runtime of the lamp.</p> <p>15 <b>[SELF TEST]</b><br/>Displays the self-test information.</p> <p>16 <b>[PROJECTOR RUNTIME]</b><br/>Displays the runtime of the projector.</p> |
|---|---|

**Error information page**

When [Error (Detail)] or [Warning (Detail)] is displayed in the self-test display of the [Projector status] screen, click it to display the error/warning details.

- The projector may go into the standby status to protect the projector depending on the contents of the error.

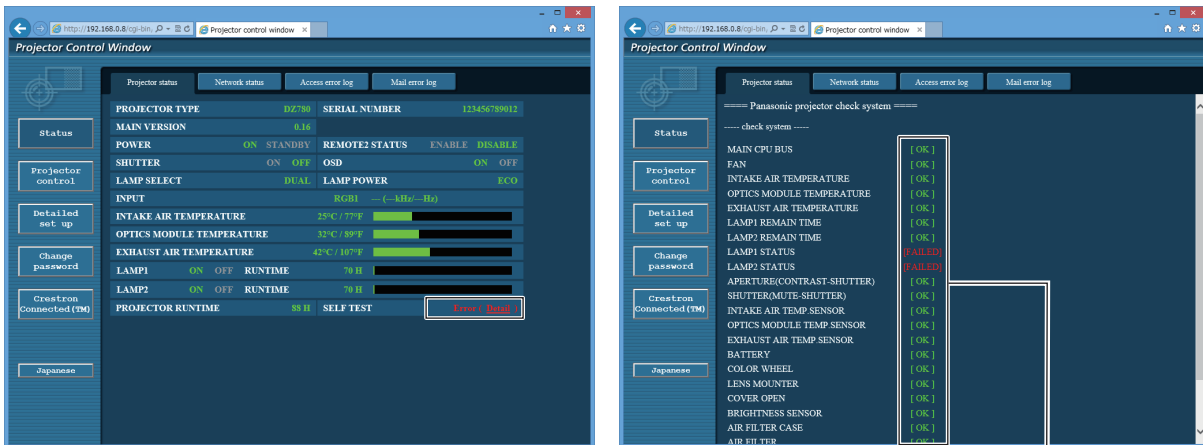

1

**1 Self-test result display**

Displays the item check results.

**[OK]:**

Indicates that operation is normal.

**[FAILED]:**

Indicates that there is a problem.

**[WARNING]:**

Indicates that there is a warning.

**■ [FAILED] items**

Item	Description
[MAIN CPU BUS]	There is a problem with the microcomputer circuitry. Consult your dealer.
[FAN]	There is a problem with the fan or the fan drive circuit. Consult your dealer.
[INTAKE AIR TEMPERATURE]	The intake air temperature is high. The projector may be used in an environment where the temperature is high, such as near a heating appliance.
[OPTICS MODULE TEMPERATURE]	The temperature around the optics module inside the projector is high. The projector may be used in an environment where the temperature is high, such as near a heating appliance.
[EXHAUST AIR TEMPERATURE]	The exhaust air temperature is high. The air exhaust port may be blocked.
[LAMP1 REMAIN TIME]	The runtime of the lamp has exceeded the specified time, and it is time to replace the lamp.
[LAMP2 REMAIN TIME]	
[LAMP1 STATUS]	The lamp has failed to turn on. Wait a while until the luminous lamp cools off, and then turn on the power.
[LAMP2 STATUS]	
[APERTURE(CONTRAST-SHUTTER)]	There is a problem with the contrast shutter circuitry. Consult your dealer.
[SHUTTER(MUTE-SHUTTER)]	There is a problem with the shutter circuitry. Consult your dealer.
[INTAKE AIR TEMP.SENSOR]	There is a problem with the sensor used to detect intake air temperature. Consult your dealer.
[OPTICS MODULE TEMP.SENSOR]	There is a problem with the sensor used to detect temperature inside the projector. Consult your dealer.
[EXHAUST AIR TEMP.SENSOR]	There is a problem with the sensor used to detect exhaust air temperature. Consult your dealer.
[COLOR WHEEL]	There is a problem with the color wheel or the color wheel drive circuit. Consult your dealer.
[LENS MOUNTER]	There is a problem in the lens mounter. Consult your dealer.
[COVER OPEN]	Installation of the lamp unit cover is incomplete. Check the installation of the lamp unit cover. (► page 167)
[BRIGHTNESS SENSOR]	There is a problem with the brightness sensor. If problems persist even after switching on the power, consult your dealer.

■ [WARNING] items

Item	Description
[AC POWER]	AC input voltage is weak. Use electric wiring that can sufficiently withstand the power consumption of the projector.
[LOW-TEMPERATURE]	The temperature around the optics module inside the projector is low. Projection cannot be started until the optics module becomes warm.
[HORIZONTAL TILT]	The projector is used tilted at an angle that exceeds 15° from the horizontal plane.
[LIGHT OUTPUT LIMIT]	The projector may be used in an environment where the temperature is high. The light output is reduced by approx. 20 % to protect the projector.
[INTAKE AIR TEMPERATURE]	The intake air temperature is high. The projector may be used in an environment where the temperature is high, such as near a heating appliance.
[OPTICS MODULE TEMPERATURE]	The temperature around the optics module inside the projector is high. The projector may be used in an environment where the temperature is high, such as near a heating appliance.
[EXHAUST AIR TEMPERATURE]	The exhaust air temperature is high. The air exhaust port may be blocked.
[LAMP1 REMAIN TIME]	The runtime of the lamp has exceeded the specified time, and it is time to replace the lamp.
[LAMP2 REMAIN TIME]	
[BATTERY]	Battery replacement is required. Consult your dealer.
[AIR FILTER CASE]	The air filter case is not attached. Check the attachment of the air filter unit. (➡ page 165)
[AIR FILTER]	There is too much dust accumulated in the air filter. Turn the <MAIN POWER> switch <OFF> (➡ page 61), and clean the air filter. (➡ page 165)

[Network status] page

Click [Status] → [Network status].

The current network setting status is displayed.

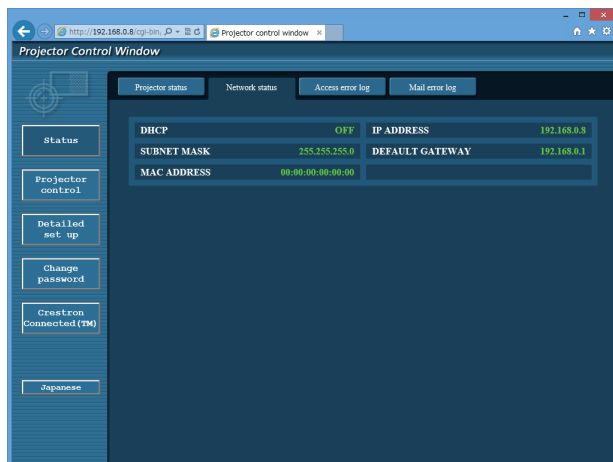

### [Access error log] page

Click [Status] → [Access error log].

The error log on the web server is displayed such as access to the pages that do not exist or access with unauthorized user names or passwords.

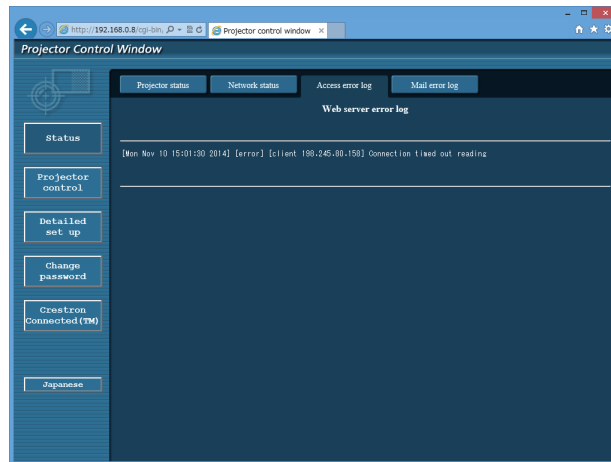

### [Mail error log] page

Click [Status] → [Mail error log].

Display E-mail error information if periodic E-mail sending has failed.

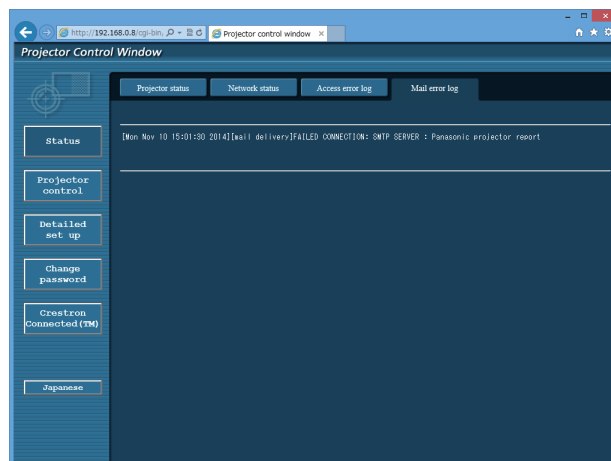

### Note

- [Access error log] and [Mail error log] display the recent few thousand accesses/requests. All information may not be displayed when many accesses/requests are made at one time.
- When [Access error log] and [Mail error log] exceed certain amount, information is erased from the oldest.
- Check [Access error log] and [Mail error log] periodically.

**[Basic control] page**

Click [Projector control] → [Basic control].

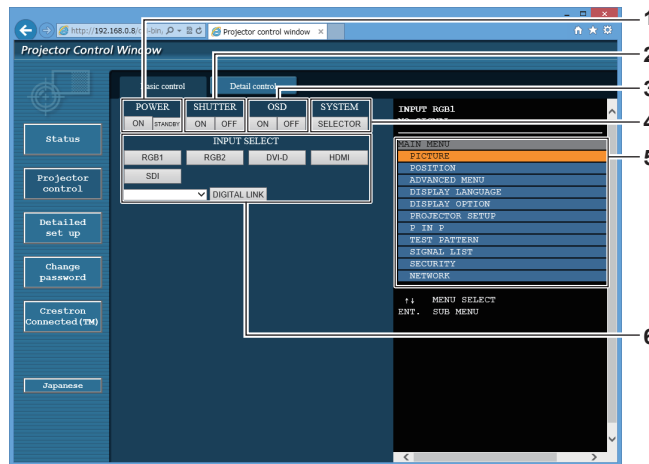

- 1 **[POWER]**  
Turns on/off the power.
- 2 **[SHUTTER]**  
Switches whether to use the shutter function (enabled (shutter: closed)/disabled (shutter: open)).
- 3 **[OSD]**  
Switches on (display)/off (hide) the on-screen display function.
- 4 **[SYSTEM]**  
Switches the system method.
- 5 **On-screen display of the projector**  
Displays the same items as shown on the on-screen display of the projector. You can check or change the settings of the menus. It is displayed even if the on-screen display function is set to off (hide).
- 6 **[INPUT SELECT]**  
Switches the input signal. (SDI input is supported only for PT-DZ780.)

**[Detail control] page**

Click [Projector control] → [Detail control].

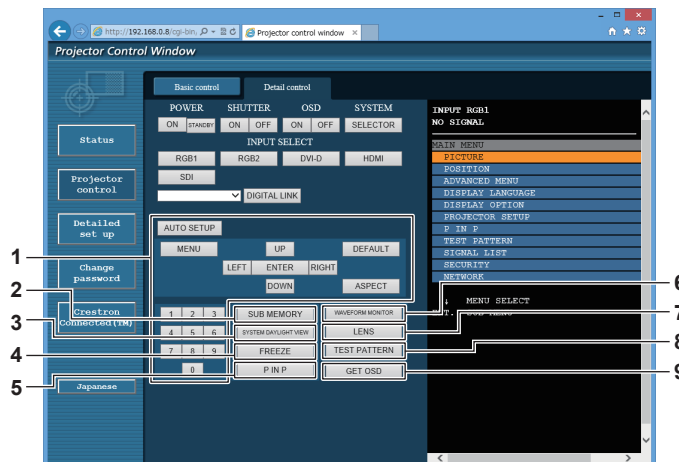

- 1 **Control of the projector**  
The projector is controlled by clicking the buttons in the same way as the buttons on the remote control. After control, the on-screen display of the projector at the right of the control page is updated.
- 2 **[SUB MEMORY]**  
Switches the sub memory.
- 3 **[SYSTEM DAYLIGHT VIEW]**  
Switches to system daylight view settings.
- 4 **[FREEZE]**  
Freezes the image temporarily.
- 5 **[P IN P]**  
Switches the P IN P setting.
- 6 **[WAVEFORM MONITOR]**  
Displays the waveform of the input signal.
- 7 **[LENS]**  
Adjusts the projection lens.
- 8 **[TEST PATTERN]**  
Displays the test pattern.
- 9 **[GET OSD]**  
Updates the on-screen display of the projector at the right of the control page.

[Network config] page

Click [Detailed set up] → [Network config].

- Click [Network config] to display the **[CAUTION!]** screen.
- The current settings are displayed by pressing the [Next] button.
- Click [Change] to display the setting change screen.

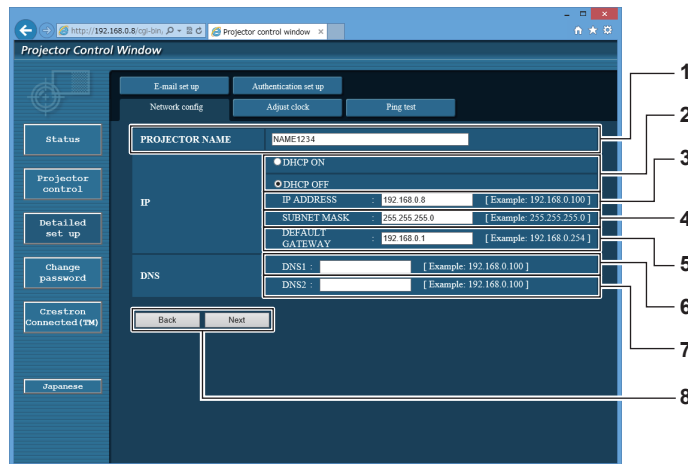

- |   |  |
|---|--|
| <p><b>1 [PROJECTOR NAME]</b><br/>Enter the name of the projector. Enter the host name if it is required when using a DHCP server etc.</p> <p><b>2 [DHCP ON], [DHCP OFF]</b><br/>To enable the DHCP client function, set to [DHCP ON].</p> <p><b>3 [IP ADDRESS]</b><br/>Enter the IP address when not using a DHCP server.</p> <p><b>4 [SUBNET MASK]</b><br/>Enter the subnet mask when not using a DHCP server.</p> <p><b>5 [DEFAULT GATEWAY]</b><br/>Enter the default gateway address when not using a DHCP server.</p> | <p><b>6 [DNS1]</b><br/>Enter the DNS1 server address.<br/>Permissible characters for the entry of DNS1 server address (primary):<br/>Numbers (0 - 9), period (.)<br/>(Example: 192.168.0.253)</p> <p><b>7 [DNS2]</b><br/>Enter the DNS2 server address.<br/>Available characters for the entry of DNS2 server address (secondary):<br/>Numbers (0 - 9), period (.)<br/>(Example: 192.168.0.254)</p> <p><b>8 [Back], [Next]</b><br/>Click the [Back] button to return to the original screen. The current settings are displayed by pressing the [Next] button. Click the [Submit] button to update the settings.</p> |
|---|--|

**Note**

- When you use the “Forward” and “Back” functions of your browser, a warning message “Page has Expired” may appear. In that case, click [Network config] again since the following operation LAN will not be guaranteed.
- Changing LAN settings while connected to the LAN may cause the connection to cut out.

[Adjust clock] page

Click [Detailed set up] → [Adjust clock].

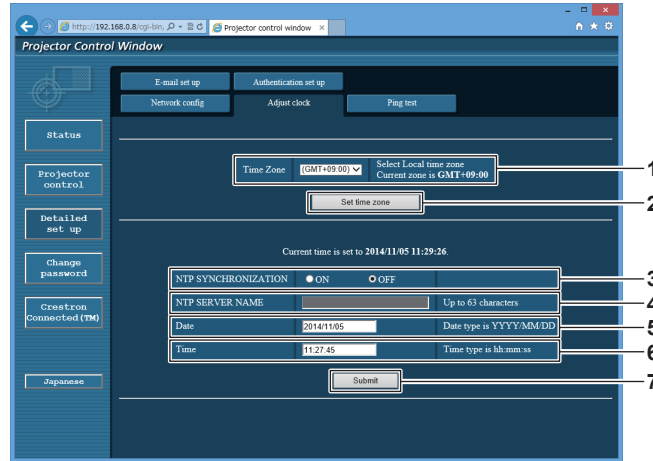

- |   |  |
|---|--|
| <p>1 <b>[Time Zone]</b><br/>Select the time zone.</p> <p>2 <b>[Set time zone]</b><br/>Updates the time zone setting.</p> <p>3 <b>[NTP SYNCHRONIZATION]</b><br/>Set to [ON] to adjust the date and time automatically.</p> <p>4 <b>[NTP SERVER NAME]</b><br/>Enter the IP address or server name of the NTP server when you set to adjust the date and time manually.<br/>(To enter the server name, the DNS server needs to be configured.)</p> | <p>5 <b>[Date]</b><br/>Enter the date to be changed.</p> <p>6 <b>[Time]</b><br/>Enter the time to be changed.</p> <p>7 <b>[Submit]</b><br/>Updates the date and time settings.</p> |
|---|--|

**Note**

- The replacement of the battery inside the projector is required when the time goes out of alignment right after correcting the time. Consult your dealer.

[Ping test] page

Check whether the network is connected to the E-mail server, POP server, DNS server, etc.

Click [Detailed set up] → [Ping test].

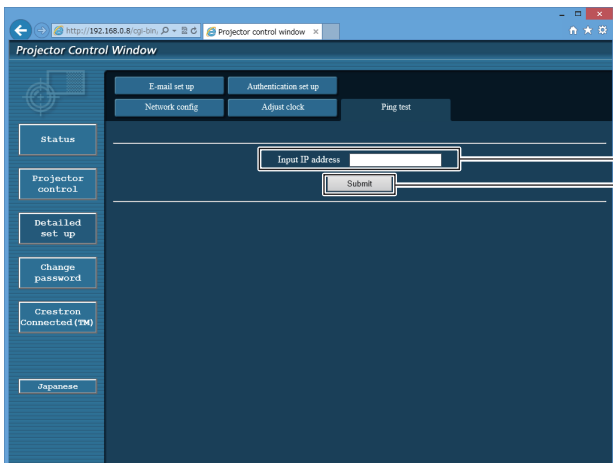

```

PING 192.168.0.50 (192.168.0.50): 56 data bytes
64 bytes from 192.168.0.50: seq=0 ttl=128 time=1 ms
64 bytes from 192.168.0.50: seq=1 ttl=128 time=1 ms
64 bytes from 192.168.0.50: seq=2 ttl=128 time=1 ms
64 bytes from 192.168.0.50: seq=3 ttl=128 time=1 ms

--- 192.168.0.50 ping statistics ---
4 packets transmitted, 4 packets received, 0% packet loss
round-trip min/avg/max = 1/1/1 ms

PING 192.168.0.51 (192.168.0.51): 56 data bytes
--- 192.168.0.51 ping statistics ---
4 packets transmitted, 0 packets received, 100% packet loss
    
```

- |  |  |
|--|--|
| <p>1 <b>[Input IP address]</b><br/>Enter the IP address of the server to be tested.</p> <p>2 <b>[Submit]</b><br/>Executes the connection test.</p> | <p>3 <b>Example of display when the connection has succeeded</b></p> <p>4 <b>Example of display when the connection has failed</b></p> |
|--|--|



**[E-mail set up] page**

When there is a problem or the runtime of the lamp reaches a set value, an E-mail can be sent to preset E-mail addresses (up to two addresses).

Click [Detailed set up] → [E-mail set up].

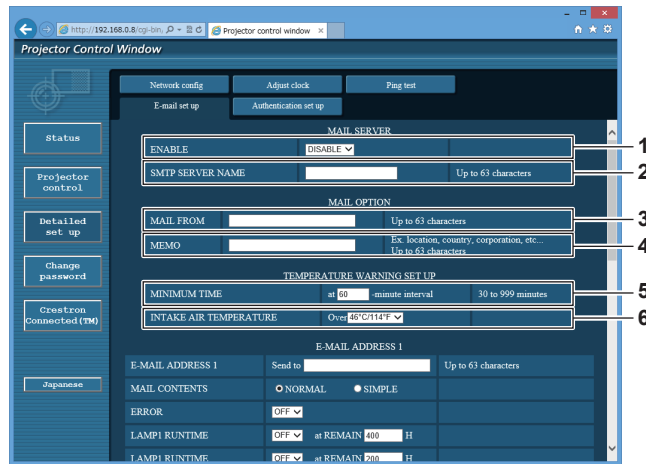

- |   |   |
|---|---|
| <p><b>1 [ENABLE]</b><br/>Select [Enable] to use the E-mail function.</p> <p><b>2 [SMTP SERVER NAME]</b><br/>Enter the IP address or the server name of the E-mail server (SMTP). To enter the server name, the DNS server needs to be set up.</p> <p><b>3 [MAIL FROM]</b><br/>Enter the E-mail address of the projector. (Up to 63 characters in single byte)</p> <p><b>4 [MEMO]</b><br/>Enter information such as the location of the projector that notifies the sender of the E-mail. (Up to 63 characters in single byte)</p> | <p><b>5 [MINIMUM TIME]</b><br/>Change the minimum interval for the temperature warning E-mail. The default value is 60 minutes. In this case, another E-mail will not be sent for 60 minutes after sending the temperature warning E-mail even if it reaches the warning temperature.</p> <p><b>6 [INTAKE AIR TEMPERATURE]</b><br/>Change the temperature setting for the temperature warning mail. A temperature warning E-mail is sent when the temperature exceeds this value.</p> |
|---|---|

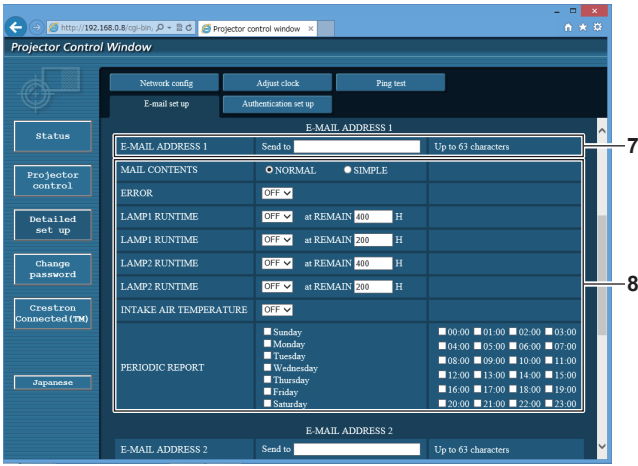

**7 [E-MAIL ADDRESS 1], [E-MAIL ADDRESS 2]**  
Enter the E-mail address to be sent. Leave [E-MAIL ADDRESS 2] blank when two E-mail addresses are not to be used.

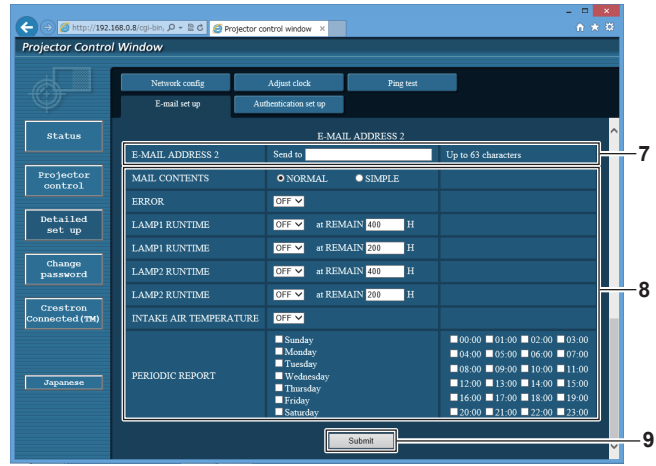

**8 Settings of the conditions to send E-mail**  
Select the conditions to send E-mail.  
**[MAIL CONTENTS]:**  
Select either [NORMAL] or [SIMPLE].  
**[ERROR]:**  
Send an E-mail when an error occurred in the self-test.  
**[LAMP1 RUNTIME]:**  
Send an E-mail when the remaining lamp runtime for the lamp 1 has reached the value set at the right field.  
**[LAMP2 RUNTIME]:**  
Send an E-mail when the remaining lamp runtime for the lamp 2 has reached the value set at the right field.  
**[INTAKE AIR TEMPERATURE]:**  
Send an E-mail when the intake air temperature has reached the value set at the above field.  
**[PERIODIC REPORT]:**  
Place a check mark on this to send an E-mail periodically. It will be sent on the days and time with the check mark.

**9 [Submit]**  
Update the settings.

**[Authentication set up] page**

Set the authentication items when POP authentication or SMTP authentication is necessary to send an E-mail. Click [Detailed set up] → [Authentication set up].

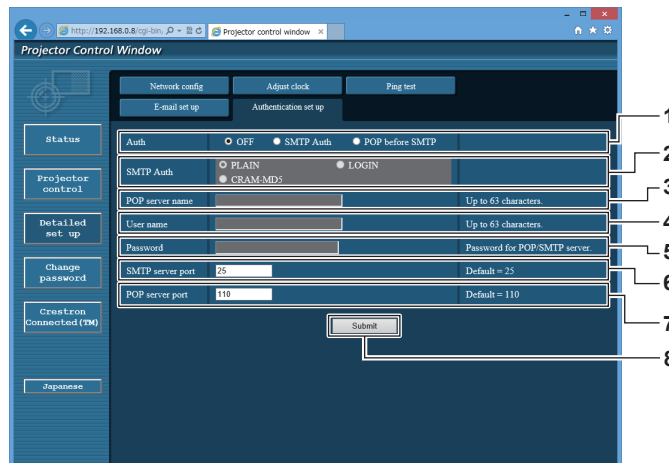

**1 [Auth]**  
Select the authentication method specified by your Internet service provider.

**2 [SMTP Auth]**  
Set when the SMTP authentication is selected.

**3 [POP server name]**  
Enter the POP server name.  
Allowed characters:  
Alphanumerics (A - Z, a - z, 0 - 9)  
Minus sign (-) and period (.)

**4 [User name]**  
Enter the user name for the POP server or the SMTP server.

**5 [Password]**  
Enter the password for the POP server or the SMTP server.

**6 [SMTP server port]**  
Enter the port number of the SMTP server. (Normally 25)

**7 [POP server port]**  
Enter the port number of the POP server. (Normally 110)

**8 [Submit]**  
Update the settings.

## Contents of E-mail sent

## Example of the E-mail sent when E-mail is set

The following E-mail is sent when the E-mail settings have been established.

```

=== Panasonic projector report(CONFIGURE) ===
Projector Type   : DZ780
Serial No       : 123456789012

----- E-mail setup data -----
TEMPERATURE WARNING SETUP
MINIMUM TIME    at [ 60] minutes interval
INTAKE AIR TEMPERATURE      Over [ 46 degC / 114 degF ]

ERROR           [ ON ]
LAMP1 RUNTIME   [ ON ] at REMAIN [ 400] H
LAMP1 RUNTIME   [ ON ] at REMAIN [ 200] H
LAMP2 RUNTIME   [ ON ] at REMAIN [ 400] H
LAMP2 RUNTIME   [ ON ] at REMAIN [ 200] H
INTAKE AIR TEMPERATURE [ OFF ]
PERIODIC REPORT
Sunday [ OFF ] Monday [ OFF ] Tuesday [ OFF ] Wednesday [ OFF ]
Thursday [ OFF ] Friday [ OFF ] Saturday [ OFF ]

00:00 [ OFF ] 01:00 [ OFF ] 02:00 [ OFF ] 03:00 [ OFF ]
04:00 [ OFF ] 05:00 [ OFF ] 06:00 [ OFF ] 07:00 [ OFF ]
08:00 [ OFF ] 09:00 [ OFF ] 10:00 [ OFF ] 11:00 [ OFF ]
12:00 [ OFF ] 13:00 [ OFF ] 14:00 [ OFF ] 15:00 [ OFF ]
16:00 [ OFF ] 17:00 [ OFF ] 18:00 [ OFF ] 19:00 [ OFF ]
20:00 [ OFF ] 21:00 [ OFF ] 22:00 [ OFF ] 23:00 [ OFF ]

----- check system -----
MAIN CPU BUS           [ OK ]
FAN                    [ OK ]
INTAKE AIR TEMPERATURE [ OK ]
OPTICS MODULE TEMPERATURE [ OK ]
EXHAUST AIR TEMPERATURE [ OK ]
LAMP1 REMAIN TIME      [ OK ]
LAMP2 REMAIN TIME      [ OK ]
LAMP1 STATUS           [ FAILED ]
LAMP2 STATUS           [ FAILED ]
APERTURE(CONTRAST-SHUTTER) [ OK ]
SHUTTER(MUTE-SHUTTER) [ OK ]
INTAKE AIR TEMP.SENSOR [ OK ]
OPTICS MODULE TEMP.SENSOR [ OK ]
EXHAUST AIR TEMP.SENSOR [ OK ]
BATTERY                [ OK ]
COLOR WHEEL            [ OK ]
LENS MOUNTER           [ OK ]
COVER OPEN             [ OK ]
BRIGHTNESS SENSOR      [ OK ]
AIR FILTER CASE        [ OK ]
AIR FILTER             [ OK ]
AC POWER               [ OK ]
(Error code 00 00 00 60 00 00 00 00 00 00 00 03 00 00 00)

Intake air temperature : --- degC / --- degF
Optics module temperature : --- degC / --- degF
Exhaust air temperature : --- degC / --- degF
PROJECTOR RUNTIME      21 H
POWER ON               34 times
LAMP1 ON               0 times
LAMP1 ECO              0 H
LAMP1 NORMAL           0 H
LAMP1 REMAIN           4000 H
LAMP2 ON               0 times
LAMP2 ECO              0 H
LAMP2 NORMAL           0 H
LAMP2 REMAIN           4000 H

----- Current status -----
MAIN VERSION           0.16
SUB VERSION            0.01.01
LAMP STATUS            LAMP1=OFF LAMP2=OFF
INPUT                  RGB2
REMOTE2 STATUS         DISABLE

----- Wired Network configuration -----
DHCP Client            OFF
IP address             192.168.0.8
MAC address            10.20:30:40:50:60

Mon Jan 01 12:34:56 20XX

----- Memo -----

```

## Example of the E-mail sent for an error

The following E-mail is sent when an error has occurred.

```

=== Panasonic projector report(ERROR) ===
Projector Type   : DZ780
Serial No       : 123456789012

----- check system -----
MAIN CPU BUS           [ OK ]
FAN                   [ OK ]
INTAKE AIR TEMPERATURE [ OK ]
OPTICS MODULE TEMPERATURE [ OK ]
EXHAUST AIR TEMPERATURE [ OK ]
LAMP1 REMAIN TIME     [ OK ]
LAMP2 REMAIN TIME     [ OK ]
LAMP1 STATUS          [ FAILED ]
LAMP2 STATUS          [ FAILED ]
APERTURE(CONTRAST-SHUTTER) [ OK ]
SHUTTER(MUTE-SHUTTER) [ OK ]
INTAKE AIR TEMP.SENSOR [ OK ]
OPTICS MODULE TEMP.SENSOR [ OK ]
EXHAUST AIR TEMP.SENSOR [ OK ]
BATTERY               [ OK ]
COLOR WHEEL           [ OK ]
LENS MOUNTER          [ OK ]
COVER OPEN            [ OK ]
BRIGHTNESS SENSOR    [ OK ]
AIR FILTER CASE       [ OK ]
AIR FILTER             [ OK ]
AC POWER              [ OK ]
(Error code 00 00 00 60 00 00 00 00 00 00 00 03 00 00 00)

Intake air temperature : --- degC / --- degF
Optics module temperature : --- degC / --- degF
Exhaust air temperature : --- degC / --- degF
PROJECTOR RUNTIME      21 H
POWER ON                34 times
LAMP1 ON                0 times
LAMP1 ECO               0 H
LAMP1 NORMAL            0 H
LAMP1 REMAIN            4000 H
LAMP2 ON                0 times
LAMP2 ECO               0 H
LAMP2 NORMAL            0 H
LAMP2 REMAIN            4000 H

----- Current status -----
MAIN VERSION           0.16
SUB VERSION            0.01.01
LAMP STATUS            LAMP1=OFF LAMP2=OFF
INPUT                  RGB2
REMOTE2 STATUS         DISABLE

----- Wired Network configuration -----
DHCP Client            OFF
IP address              192.168.0.8
MAC address             10:20:30:40:50:60

Mon Jan 01 12:34:56 20XX

----- Memo -----

```

**[Change password] page**

Click [Change password].

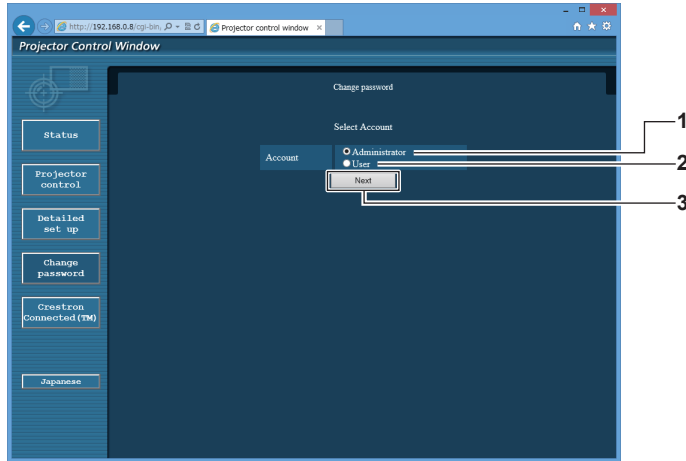

- 1 **[Administrator]**  
Used to change the setting of the [Administrator].
- 2 **[User]**  
Used to change the setting of the [User].
- 3 **[Next]**  
Used to change the setting of the password.

**[Administrator] account**

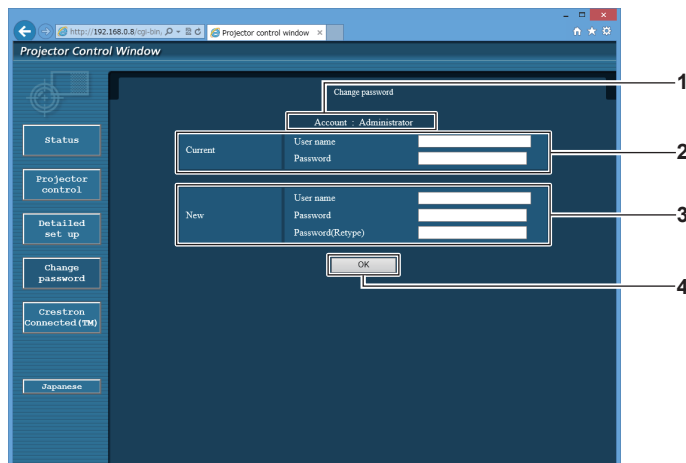

- 1 **[Account]**  
Displays the account to change.
- 2 **[Current]**  
**[User name]:**  
Enter the user name before the change.  
**[Password]:**  
Enter the current password.
- 3 **[New]**  
**[User name]:**  
Enter the desired new user name. (Up to 16 characters in single byte)  
**[Password]:**  
Enter the desired new password. (Up to 16 characters in single byte)  
**[Password(Retyp)]:**  
Enter the desired new password again.
- 4 **[OK]**  
Determines the change of password.

[User] account

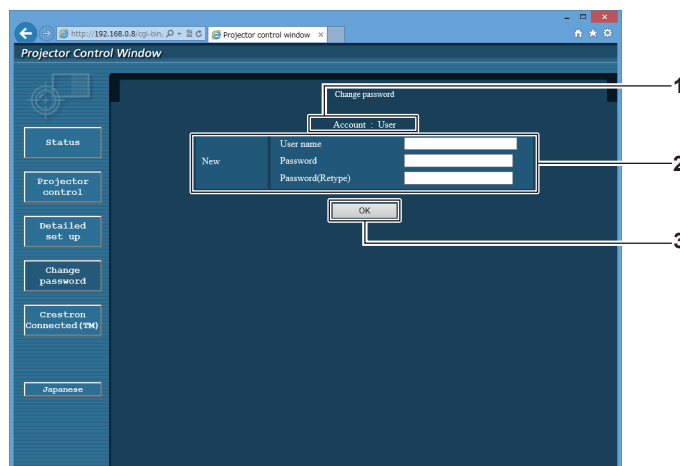

- |  |   |
|--|---|
| <p>1 <b>[Account]</b><br/>Displays the account to change.</p> <p>2 <b>[New]</b><br/><b>[User name]:</b><br/>Enter the desired new user name. (Up to 16 characters in single byte)<br/><b>[Password]:</b><br/>Enter the desired new password. (Up to 16 characters in single byte)<br/><b>[Password(Retype)]:</b><br/>Enter the desired new password again.</p> | <p>3 <b>[OK]</b><br/>Determines the change of password.</p> |
|--|---|

[Change password] (For user rights)

Only the change of password is enabled under the user rights.

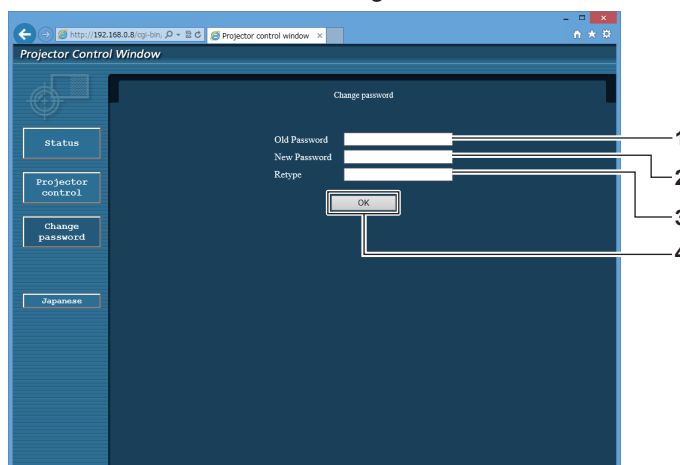

- |  |  |
|--|--|
| <p>1 <b>[Old Password]</b><br/>Enter the current password.</p> <p>2 <b>[New Password]</b><br/>Enter the desired new password. (Up to 16 characters in single byte)</p> | <p>3 <b>[Retype]</b><br/>Enter the desired new password again.</p> <p>4 <b>[OK]</b><br/>Determines the change of password.</p> |
|--|--|

**Note**

- To change the account of the administrator, you must enter the [User name] and [Password] in [Current].

**[Crestron Connected(TM)] page**

The projector can be monitored/controlled with Crestron Connected™.

To start the operation page of Crestron Connected™ from the web control screen, you need to access with the administrator rights. (For user rights, the [Crestron Connected(TM)] button is not displayed on the web control screen.)

The operation page of Crestron Connected™ is displayed by clicking [Crestron Connected(TM)].

It is not displayed if Adobe Flash Player is not installed on your computer, or the browser you use does not support Flash. In that case, click [Back] on the operation page to go back to the previous page.

Operation page

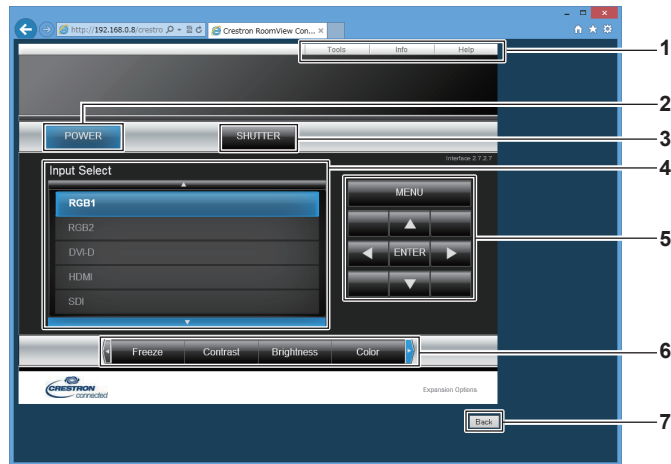

- |  |   |
|--|---|
| <p><b>1 [Tools], [Info], [Help]</b><br/>Tabs for selecting the setting, information, or help page of the projector.</p> <p><b>2 [POWER]</b><br/>Turns on/off the power.</p> <p><b>3 [SHUTTER]</b><br/>Switches whether to use the shutter function (enabled (shutter: closed)/disabled (shutter: open)).</p> | <p><b>4 [Input Select]</b><br/>Controls input selection.<br/>Not available when the power of the projector is turned off.</p> <p><b>5 Menu screen control buttons</b><br/>Navigates the menu screen.</p> <p><b>6 Freeze/image quality adjustment</b><br/>Controls items related to freeze/image quality.</p> <p><b>7 [Back]</b><br/>Performs return to the previous page.</p> |
|--|---|

[Tools] page

Click [Tools] on the operation page.

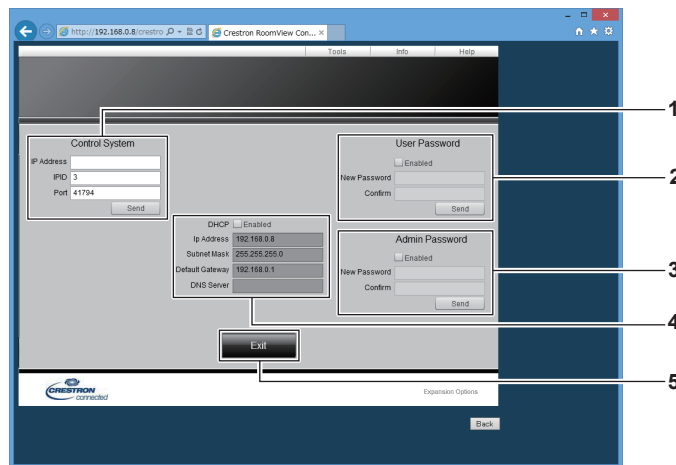

- |   |  |
|---|--|
| <p><b>1 [Control System]</b><br/>Set the information required for communicating with the controller to be connected with the projector.</p> <p><b>2 [User Password]</b><br/>Set the user rights password for the operation page of Crestron Connected™.</p> <p><b>3 [Admin Password]</b><br/>Set the administrator rights password for the operation page of Crestron Connected™.</p> | <p><b>4 Network status</b><br/>Displays the settings of wired LAN.<br/><b>[DHCP]</b><br/>Displays the current setting.<br/><b>[Ip Address]</b><br/>Displays the current setting.<br/><b>[Subnet Mask]</b><br/>Displays the current setting.<br/><b>[Default Gateway]</b><br/>Displays the current setting.<br/><b>[DNS Server]</b><br/>Displays the current setting.</p> <p><b>5 [Exit]</b><br/>Returns to the operation page.</p> |
|---|--|

**[Info] page**

Click [Info] on the operation page.

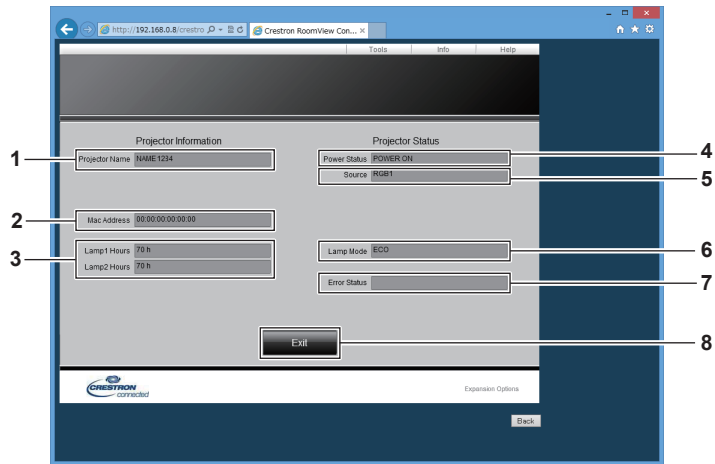

- |  |   |
|--|---|
| <p><b>1 [Projector Name]</b><br/>Displays the projector name.</p> <p><b>2 [Mac Address]</b><br/>Displays the MAC address.</p> <p><b>3 [Lamp1 Hours], [Lamp2 Hours]</b><br/>Displays the runtime of the lamp 1 and the lamp 2.</p> <p><b>4 [Power Status]</b><br/>Displays the status of the power.</p> | <p><b>5 [Source]</b><br/>Displays the selected input.</p> <p><b>6 [Lamp Mode]</b><br/>Displays the setting status of [LAMP POWER] (➔ page 113).</p> <p><b>7 [Error Status]</b><br/>Displays the error status.</p> <p><b>8 [Exit]</b><br/>Returns to the operation page.</p> |
|--|---|

**[Help] page**

Click [Help] on the operation page.  
The [Help Desk] window is displayed.

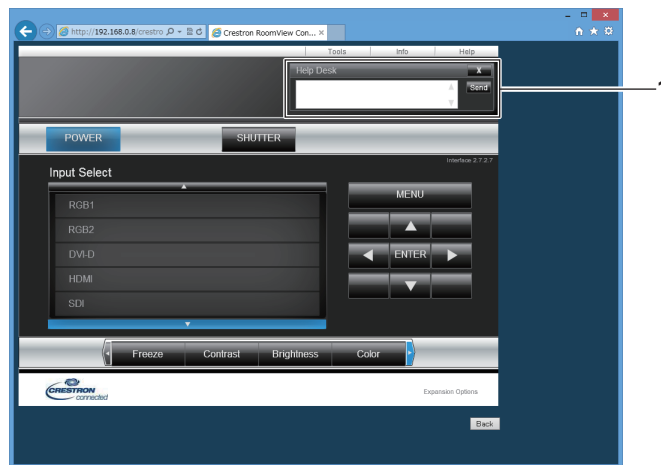

- 1 [Help Desk]**  
Send/receive messages to/from an administrator who uses Crestron Connected™.



# Chapter 5 Maintenance

---

This chapter describes methods of inspection when there are problems, maintenance, and replacement of the components.

# Lamp/temperature/filter indicators

## When an indicator lights up

If a problem should occur inside the projector, the lamp indicators <LAMP1>/<LAMP2>, the temperature indicator <TEMP>, and the filter indicator <FILTER> will inform you by lighting or blinking. Check the status of the indicators and manage the indicated problems as follows.

### Attention

- When switching off the projector to deal with problems, make sure to follow the procedure in “Switching off the projector” (➔ page 61).

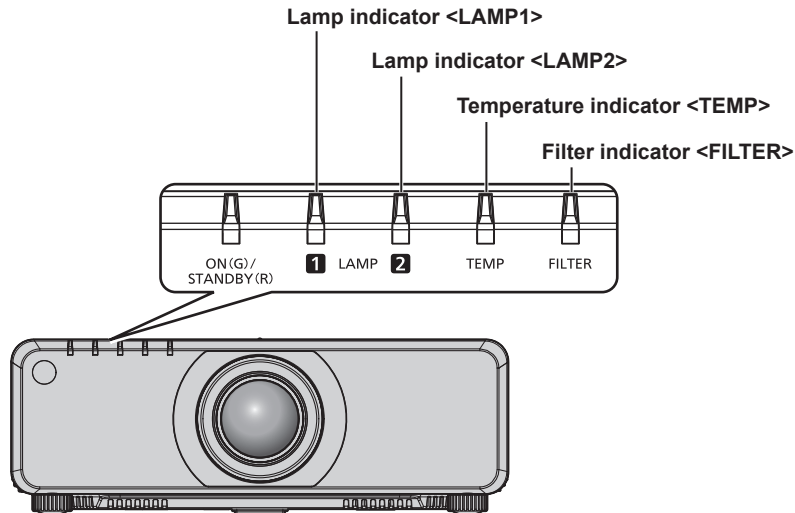

## Lamp indicators <LAMP1>/<LAMP2>

Indicator status	Lighting in red/lighting in orange*1	Blinking in red (1 time)	Blinking in red (3 times)	
Status	Time to replace the lamp unit. (➔ page 166)	The lamp unit is not attached.	A problem is detected in the lamp or the power supply for the lamp.	
Cause	<ul style="list-style-type: none"> <li>Was [REPLACE LAMP] displayed when you turned on the power?</li> <li>The indicator lights up when the runtime of the lamp unit reaches 3 800 hours (when [LAMP POWER] is set to [NORMAL]).</li> </ul>	<ul style="list-style-type: none"> <li>Is the lamp unit attached?</li> </ul>	<ul style="list-style-type: none"> <li>Have you turned on the power again immediately after turning it off?</li> </ul>	<ul style="list-style-type: none"> <li>Some error has occurred in the lamp circuit. Check for fluctuation (or drop) in the source voltage.</li> </ul>
Solution	<ul style="list-style-type: none"> <li>Replace the lamp unit.</li> </ul>	<ul style="list-style-type: none"> <li>Attach the lamp unit if it is not attached.</li> <li>If the indicator is still blinking in red even when the lamp unit is attached, consult your dealer.</li> </ul>	<ul style="list-style-type: none"> <li>Wait a while until the luminous lamp cools off, and then turn on the power.</li> </ul>	<ul style="list-style-type: none"> <li>Turn the &lt;MAIN POWER&gt; switch to &lt;OFF&gt; (➔ page 61), and consult your dealer.</li> </ul>

\*1 The indicator lights up in red while the lamp is turned off, and lights up in orange while the lamp is turned on.

### Note

- If the lamp indicators <LAMP1>/<LAMP2> are still lit or blinking after taking the measures, ask your dealer for repair.
- The lamp indicator corresponding to the lamp being lit will light up in green if the projector is in projection mode and there is no indication of problem by lighting or blinking in red or orange.

**Temperature indicator <TEMP>**

Indicator status	Lighting in red		Blinking in red (2 times)	Blinking in red (3 times)
<b>Status</b>	Warm-up status	Internal temperature is high (warning).	Internal temperature is high (standby status).	The cooling fan has stopped.
<b>Cause</b>	<ul style="list-style-type: none"> <li>Did you turn on the power when the temperature was low (around 0 °C (32 °F))?</li> </ul>	<ul style="list-style-type: none"> <li>Is the air intake/exhaust port blocked?</li> <li>Is the room temperature high?</li> <li>Is the filter indicator &lt;FILTER&gt; lit?</li> </ul>		—
<b>Solution</b>	<ul style="list-style-type: none"> <li>Wait at least 10 minutes in the current status.</li> <li>Install the projector in a location with the operating environment temperature between 0 °C (32 °F) and 45 °C (113 °F)*1.</li> </ul>	<ul style="list-style-type: none"> <li>Remove any objects that are blocking the air intake/exhaust port.</li> <li>Install the projector in a location with the operating environment temperature between 0 °C (32 °F) and 45 °C (113 °F)*1.</li> <li>Do not use the projector at high altitudes of 2 700 m (8 858') or higher above sea level.</li> <li>Clean or replace the air filter. (➔ page 164)</li> </ul>		<ul style="list-style-type: none"> <li>Turn the &lt;MAIN POWER&gt; switch to &lt;OFF&gt; (➔ page 61), and consult your dealer.</li> </ul>

\*1 When using the projector at high altitudes (between 1 400 m (4 593') and 2 700 m (8 858') above sea level), the operating environment temperature should be between 0 °C (32 °F) and 40 °C (104 °F).

**Note**

- If the temperature indicator <TEMP> is still lit or blinking after taking the measures, ask your dealer for repair.
- If you use the projector with the following two settings, the light output may be reduced by approx. 20 % to protect the projector when the operating environment temperature becomes 40 °C (104 °F) or higher (35 °C (95 °F) or higher when used at high altitude).
  - When [LAMP SELECT] is set to [DUAL] from the menu
  - When [LAMP POWER] is set to [NORMAL] from the menu

**Filter indicator <FILTER>**

Indicator status	Lighting in red		Blinking in red
<b>Status</b>	The filter is clogged. The temperature inside or outside the projector is abnormally high.		The air filter case is not attached.
<b>Cause</b>	<ul style="list-style-type: none"> <li>Is the air filter dirty?</li> </ul>	<ul style="list-style-type: none"> <li>Is the air intake/exhaust port blocked?</li> </ul>	<ul style="list-style-type: none"> <li>Is the air filter case attached?</li> </ul>
<b>Solution</b>	<ul style="list-style-type: none"> <li>Clean or replace the air filter. (➔ page 164)</li> </ul>	<ul style="list-style-type: none"> <li>Remove any objects that are blocking the air intake/exhaust port.</li> </ul>	<ul style="list-style-type: none"> <li>Attach the air filter case.</li> </ul>

**Note**

- If the filter indicator <FILTER> is still lit or blinking after taking the measures, ask your dealer for repair.
- If the air filter case is not attached when the projector is switched on, the filter indicator <FILTER> blinks in red.

# Maintenance/replacement

## Before performing maintenance/replacement

- Make sure to turn off the power before performing maintenance/replacement. (➔ pages 55, 61)
- When switching off the projector, make sure to follow the procedures in “Switching off the projector” (➔ page 61).

## Maintenance

### Outer case

Wipe off dirt and dust with a soft, dry cloth.

- If the dirt is persistent, soak the cloth with water and wring it thoroughly before wiping. Dry off the projector with a dry cloth.
- Do not use benzene, thinner, or rubbing alcohol, other solvents, or household cleaners. Doing so may deteriorate the outer case.
- When using chemically treated dust cloths, follow the instructions written on its packaging.

### Lens front surface

Wipe off dirt and dust from the front surface of the lens with a soft clean cloth.

- Do not use a cloth that is fluffy, dusty, or soaked with oil/water.
- Since the lens is fragile, do not use excessive force when wiping the lens.

### Attention

- The lens is made of glass. Impacts or excessive force when wiping may scratch its surface. Handle with care.

### Air filter

Perform maintenance of the air filter in the following case.

- The air filter is clogged with dust, causing the filter replacement message to appear on the screen and the filter indicator <FILTER> to light in red.

### Removing the air filter

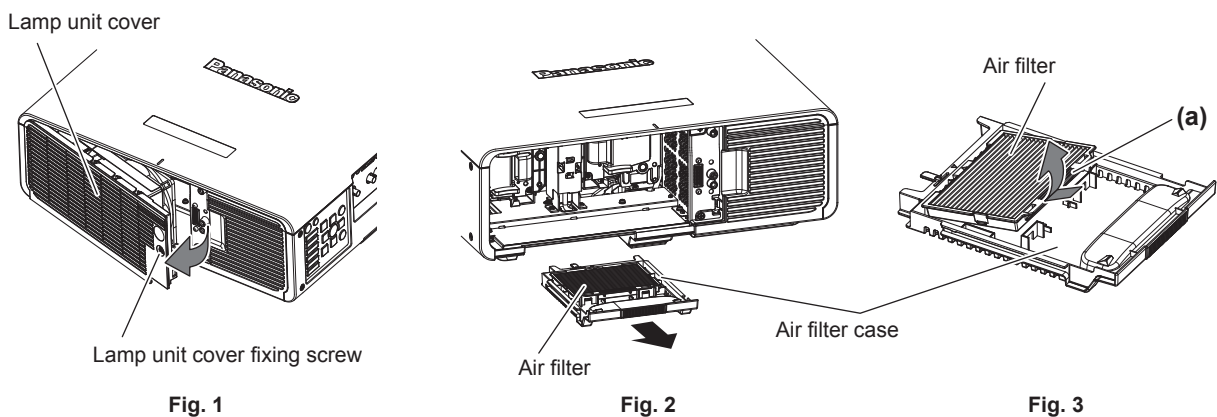

#### 1) Remove the lamp unit cover. (Fig. 1)

- Use a Phillips screwdriver to turn the lamp unit cover fixing screw (x1) counterclockwise until it turns freely, and open the lamp unit cover slowly in the direction of the arrow.
- Opening the lamp unit cover quickly may damage the cover.
- If you loosen the lamp unit cover fixing screw with the projector installed upward in the vertical direction, the lamp unit cover may open on its weight and may be dropped off.

#### 2) Pull out the air filter case. (Fig. 2)

- Pull out the air filter case from the projector.

3) **Remove the air filter from the air filter case. (Fig. 3)**

- Hold (a) of the air filter, pull up the air filter while pushing in the direction of the arrow.

**Cleaning the air filter**

Remove the air filter beforehand with the previously described procedure of “Removing the air filter”.

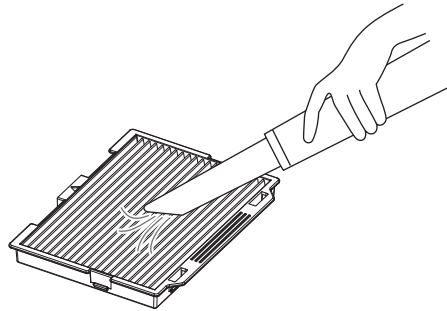

1) **Clean the air filter.**

- Vacuum dust from the air filter with a vacuum cleaner.

**Attaching the air filter**

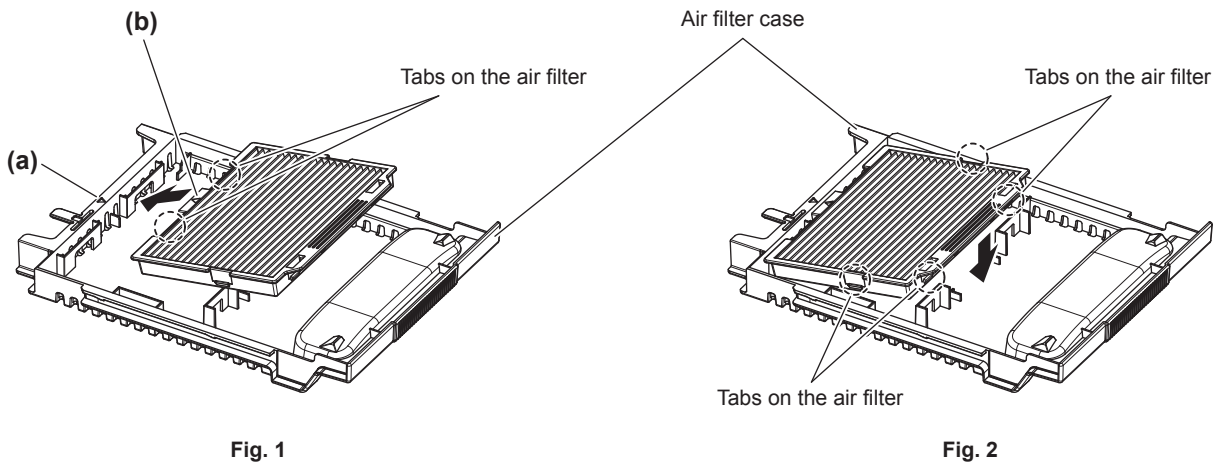

Fig. 1

Fig. 2

1) **Attach the air filter.**

- Attach the air filter by aligning the marking ( $\triangle$ ) on (a) and (b) and inserting the tabs on the air filter to the air filter case. (Fig. 1)
- Push in the air filter in the direction of the arrow, and fit the tabs securely. (Fig. 2)

2) **Attach the air filter case to the projector.**

- Insert the air filter case all the way in.

3) **Attach the lamp unit cover.**

- Perform Step 1) in “Removing the air filter” in the reverse order to close the lamp unit cover.
- Attach the lamp unit cover so that the connector on the lamp unit cover is inserted to the fan power connector securely.
- Use a Phillips screwdriver to firmly tighten the lamp unit cover fixing screw (x1).
- Make sure to attach the lamp unit cover securely.

**Note**

- Make sure that the air filter case is properly attached before using the projector. If it is not attached, the projector will suck in dirt and dust causing a malfunction.
- If you use the projector without attaching the air filter case, the filter indicator <FILTER> blinks in red and the message appears on the projected image for approximately 30 seconds.
- Do not use water when washing the air filter. Washing with water may decrease the dust absorption capability.
- When the dust remains after cleaning, it is time to replace the air filter.  
The air filter for the replacement (TMZX5229) is an optional accessory (service part). To purchase the product, consult your dealer.  
The optional Replacement lamp unit (Model No.: ET-LAD70 (1 pc), ET-LAD70W (2 pcs)) comes with one air filter.

## Replacement

### Lamp unit

The lamp unit is a consumable component. Refer to “When to replace the lamp unit” (➔ page 166) for details about the replacement cycle.

When purchasing the optional Replacement lamp unit (Model No.: ET-LAD70 (1 pc), ET-LAD70W (2 pcs)), consult your dealer.

It is recommended that you request a qualified technician to replace the lamp unit. Consult your dealer.

### WARNING

**Replace the lamp unit after the lamp has cooled (after waiting at least one hour).**  
The high temperature inside the cover will cause burns.

### Checking the lamp unit to be replaced

#### 1) Check the status of the lamp indicators <LAMP1>/<LAMP2>.

- The lamp unit corresponding to the lamp indicator that is lit in red is required to be replaced.

### Notes on the replacement of the lamp unit

- A Phillips screwdriver is necessary when replacing the lamp unit.
- Since the luminous lamp is made of glass, it may burst if dropped or hit with a hard object. Handle with care.
- Do not disassemble or modify the lamp unit.
- When replacing the lamp unit, be sure to hold it by the handle because its surface is pointed and its shape is protruded.
- The lamp may rupture. Replace the lamp unit carefully so that the glass fragments of the lamp do not scatter. While attaching the projector to the ceiling, do not work right under the lamp unit or do not conduct work while your face is near the lamp unit.
- The lamp contains mercury. When disposing of used lamp units, contact your local authorities or dealer for correct methods of disposal.

### Attention

- Panasonic takes no responsibility for any damage or malfunction of the product resulting from use of lamp units which are not manufactured by Panasonic. Use only specified lamp units.



### Note

- The model numbers of accessories and optional accessories are subject to change without prior notice.

### When to replace the lamp unit

The lamp unit is a consumable component. Since its brightness gradually decreases over time, it is necessary to replace the lamp unit regularly. The estimated duration before replacement is 4 000 hours, but the lamp may go off before reaching to 4 000 hours, depending on the characteristics of the individual lamp, usage conditions, and the installation environment. It is recommended that the Replacement lamp unit be prepared earlier.

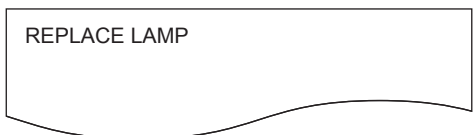
If you continue to use the lamp unit after 4 000 hours has elapsed, the lamp turns off automatically after approximately 10 minutes, as it may cause malfunction of the projector.

	On-screen display	Lamp indicator
		
Over 3 800 hours	The message is displayed for 30 seconds. Pressing any button on the control panel or remote control within 30 seconds will clear the message.	The indicator lights in red even during the standby mode. (Only the corresponding lamp lights on.)
Over 4 000 hours	The message remains displayed until you press any button.	

**Note**

- To predict when to replace the lamp, check the lamp runtime displayed on [LAMP1] and [LAMP2] in [STATUS] (➔ page 122).
- 4 000 hours is a rough estimate for replacement, and not a guaranteed time.

**How to replace the lamp unit**

**Attention**

- When the projector is mounted on the ceiling, do not conduct work while your face is near the lamp unit.
- Make sure to attach the lamp unit and the lamp unit cover securely.
- If you are having difficulty attaching the lamp unit, remove it first and then push it in again slowly. Pushing it in quickly or forcibly may break the connector.

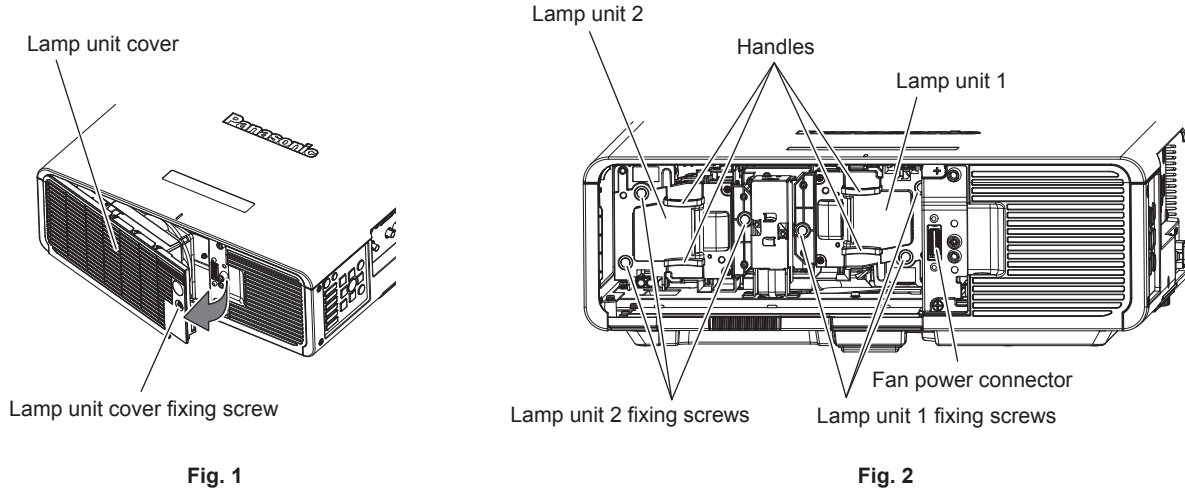

- 1) **Set the <MAIN POWER> switch to <OFF> and disconnect the power plug from the power outlet.**
  - Wait at least one hour and check if the lamp unit has cooled down.
- 2) **Remove the lamp unit cover. (Fig. 1)**
  - Use a Phillips screwdriver to turn the lamp unit cover fixing screw (x1) counterclockwise until it turns freely, and open the lamp unit cover slowly in the direction of the arrow.
  - Opening the lamp unit cover quickly may damage the cover.
  - If you loosen the lamp unit cover fixing screw with the projector installed upward in the vertical direction, the lamp unit cover may open on its weight and may be dropped off.
- 3) **Remove the lamp unit. (Fig. 2)**
  - Use a Phillips screwdriver to turn the lamp unit fixing screws (x3) counterclockwise until they turn freely, and then remove the lamp unit.
  - Hold the handles of the lamp unit and remove it straight.
- 4) **Push in the new lamp unit while paying attention to the insertion position.**
  - If you are having difficulty attaching the lamp unit, remove it first and then push it in again slowly. Pushing it in quickly or forcibly may break the connector.
- 5) **Use a Phillips screwdriver to firmly tighten the lamp unit fixing screws (x3 each).**
  - Make sure to attach the lamp unit securely.
- 6) **Attach the lamp unit cover.**
  - i) Perform Step 2) in the reverse order to close the lamp unit cover.
    - Attach the lamp unit cover so that the connector on the lamp unit cover is inserted to the fan power connector securely.
  - ii) Use a Phillips screwdriver to firmly tighten the lamp unit cover fixing screw (x1).
    - Make sure to attach the lamp unit cover securely.

**Note**

- When you replace the lamp unit with new one, the projector resets the runtime of the lamp unit automatically.

### Air filter

---

When the dust remains after cleaning, it is time to replace the air filter.

The air filter for the replacement (TMZX5229) is an optional accessory (service part). To purchase the product, consult your dealer.

When replacing the lamp unit, it is recommended to replace the air filter as well.

The optional Replacement lamp unit (Model No.: ET-LAD70 (1 pc), ET-LAD70W (2 pcs)) comes with one air filter.

---

### How to replace the air filter

---

#### Attention

---

---

- Make sure to turn off the power before replacing the air filter.
- When attaching the air filter, make sure that the projector is stable, and perform the replacement in a safe place even if you drop the air filter.

#### 1) Remove the air filter.

- Refer to “Removing the air filter” (➔ page 164).

#### 2) Replace the air filter with the new one and attach the air filter case to the projector.

- Refer to “Attaching the air filter” (➔ page 165).

#### Attention

---

---

- Before switching on the projector, make sure that the air filter is attached. If it is not attached, the projector will suck in dirt and dust causing a malfunction.
- If you use the projector without attaching the air filter case, the filter indicator <FILTER> blinks in red and the message appears on the projected image for approximately 30 seconds.



# Troubleshooting

Review the following points. For details, see the corresponding pages.

Problems	Points to be checked	Page
<b>Power does not turn on.</b>	• Is the power plug firmly inserted into the outlet?	—
	• Is the <MAIN POWER> switch set to <OFF>?	61
	• Is the wall outlet supplying electricity?	—
	• Have the circuit breakers tripped?	—
	• Are the lamp indicators <LAMP1>/<LAMP2> or the temperature indicator <TEMP> lit or blinking?	162
	• Is the lamp unit cover attached securely?	167
<b>No image appears.</b>	• Are connections to external devices correctly performed?	49
	• Is the input selection setting correct?	67
	• Is the [BRIGHTNESS] adjustment setting at a minimum?	76
	• Is the external device that is connected to the projector working properly?	—
	• Is the shutter function in use?	66
	• If the power indicator <ON (G)/STANDBY (R)> is blinking in red, consult your dealer.	—
<b>Image is fuzzy.</b>	• Is the lens focus set correctly?	62
	• Is the projection distance appropriate?	32
	• Is the lens dirty?	21
	• Is the projector installed perpendicular to the screen?	—
<b>Color is pale or grayish.</b>	• Are [COLOR] and [TINT] adjusted correctly?	77
	• Is the external device connected to the projector adjusted correctly?	49
	• Is the RGB cable damaged?	—
<b>Remote control does not respond.</b>	• Are the batteries depleted?	—
	• Is the polarity of the batteries set correctly?	28
	• Are there any obstructions between the remote control and the remote control signal receiver of the projector?	24
	• Is the remote control being used beyond its effective operation range?	24
	• Are other forms of light, such as fluorescent light, affecting the projection?	24
	• Is the [REMOTE CONTROL] setting in [CONTROL DEVICE SETUP] set to [DISABLE]?	135
	• Is the <REMOTE 2 IN> terminal used for contact control?	184
• Is the ID number setting operation correct?	69	
<b>Menu screen does not appear.</b>	• Is the on-screen display function turned off (hidden)?	104
<b>Buttons on the control panel do not operate.</b>	• Is the [CONTROL PANEL] setting in [CONTROL DEVICE SETUP] set to [DISABLE]?	135
	• Is the <REMOTE 2 IN> terminal used for contact control?	184
<b>Image does not display correctly.</b>	• Is the [SYSTEM SELECTOR] selection set correctly?	81
	• Is the [RGB1 INPUT SETTING] setting performed correctly?	98
	• Is there a problem with the video tape or other image sources?	—
	• Is a signal which is not compatible with the projector being input?	186
<b>Image from a computer does not appear.</b>	• Is the cable too long? (For D-Sub cables, the cable length should be 10 m (32'10") or shorter.)	—
	• Is the external video output on the laptop computer set correctly? (Ex.: The external output settings may be switched by pressing the "Fn" + "F3" or "Fn" + "F10" simultaneously. Since the method varies depending on the computer type, refer to the user manual provided with your computer.)	—
<b>Image output from DVI-D of the computer does not appear.</b>	• Is the [EDID SELECT] setting in [DVI-D IN] set to [EDID3] or [EDID2:PC]?	99
	• The graphics accelerator driver of the computer may need to be updated to the latest version.	—
	• The condition may be improved by making the [EDID SELECT] setting in [DVI-D IN] and then restarting the computer.	99
<b>Video from HDMI compatible device does not appear or it appears jumbled.</b>	• Is the HDMI cable connected securely?	49
	• Turn the power of the projector and the external device off and on.	—
	• Is a signal which is not compatible with the projector being input?	186
<b>Lens shift cannot be adjusted</b>	• Perform [LENS CALIBRATION].	125
	• Is the fixed-focus lens (Model No.: ET-DLE055) attached?	—

## Chapter 5 Maintenance — Troubleshooting

Problems	Points to be checked	Page
<b>Cannot control the projector with Art-Net.</b>	• Are the connections between the twisted-pair-cable transmitter and the projector or an external device correctly done?	—
	• Is [Art-Net SETUP] set to other than [OFF]?	141
	• Are the [NET], [SUB NET], [UNIVERSE], and [START ADDRESS] settings correct?	141
<b>The DIGITAL LINK input image is not displayed.</b>	• Are the connections between the twisted-pair-cable transmitter and the projector or an external device correctly done?	—
	• Is [DIGITAL LINK MODE] set to [AUTO] or [DIGITAL LINK]? Is it set to [ETHERNET]?	138
	• Is a signal which is not compatible with a twisted-pair-cable transmitter being input?	—

### Attention

- If problems persist even after checking the preceding points, consult your dealer.

## [SELF TEST] indications

Details and measures for the alphanumeric symbols indicated in [SELF TEST] from the [PROJECTOR SETUP] menu → [STATUS] (➔ page 122) are as follows.

Self-test indication	Details	Measure
U04	Filter clog	• Replace the air filter.
U11	Intake air temperature warning	• The operating environment temperature is too high. Install the projector in a location with the operating environment temperature between 0 °C (32 °F) and 45 °C (113 °F).
U12	Optical module temperature warning	
U13	Exhaust air temperature warning	
U14	Low temperature warning	• The operating environment temperature is too low. Install the projector in a location with the operating environment temperature between 0 °C (32 °F) and 45 °C (113 °F).
U15	Light output limitation	• Install the projector in a location with the operating environment temperature of 40 °C (104 °F) or lower.
U21	Intake air temperature error	• The operating environment temperature is too high. Install the projector in a location with the operating environment temperature between 0 °C (32 °F) and 45 °C (113 °F).
U22	Optical module temperature error	
U23	Exhaust air temperature error	
U24	Low temperature error	• The operating environment temperature is too low. Install the projector in a location with the operating environment temperature between 0 °C (32 °F) and 45 °C (113 °F).
U30	Portrait warning	• Install the projector horizontally (within ±15°).
U41	Lamp 1 runtime warning	• It will reach the lamp replacement time. Replace the lamp unit.
U42	Lamp 2 runtime warning	
U51	Lamp 1 failure	• Wait a while until the luminous lamp cools off, and then turn on the power.
U52	Lamp 2 failure	
U61	Lamp 1 runtime exceeded	• It has reached the lamp replacement time. Replace the lamp unit.
U62	Lamp 2 runtime exceeded	
U71	Lamp 1 not attached	• Attach the lamp unit.
U72	Lamp 2 not attached	
U76	Air filter not attached	• Attach the air filter case.
U81	Low AC voltage warning (below 90 V)	• The input power supply voltage is low. Use electric wiring that can sufficiently withstand the power consumption of the projector.
U91	Cover open	• Securely close the cover.
H01	Battery replacement for the built-in clock	• Battery replacement is required. Consult your dealer.
H11	Intake air temperature sensor not present	• If the display does not clear after switching the main power off and on, consult your dealer.
H12	Optical module temperature sensor not present	
H13	Exhaust air temperature sensor not present	
H14	Lamp 1 temperature sensor not present	
H15	Lamp 2 temperature sensor not present	
H18	Clog sensor not present	• If the display does not clear after switching the main power off and on, consult your dealer.
F00	Liquid cooling pump warning	
F11	Shutter error	
F15	Brightness sensor error	
F41	Lamp memory 1 not initialized	
F42	Lamp memory 2 not initialized	
F50	DMD fan warning	
F51	Lamp 1 fan warning	
F52	Lamp 2 fan warning	
F53	Exhaust fan 1 warning	
F54	Exhaust fan 2 warning	
F55	Color wheel fan warning	
F56	Power supply fan warning	
F57	Ballast fan warning	
F61	Ballast 1 communication error	
F62	Ballast 2 communication error	

## Chapter 5 Maintenance — [SELF TEST] indications

Self-test indication	Details	Measure
F85	Color wheel error (FM)	<ul style="list-style-type: none"> <li>If the display does not clear after switching the main power off and on, consult your dealer.</li> </ul>
F86	Color wheel error (FPGA)	
F90	FPGA configuration error	
F91	FPGA1 configuration error	
F92	FPGA2 configuration error	
F96	Lens mounter error	
F97	Geometric adjustment board communication error	
FE1	DMD fan error	<ul style="list-style-type: none"> <li>If the display does not clear after switching the main power off and on, consult your dealer.</li> </ul>
FE2	Lamp 1 fan error	
FE3	Lamp 2 fan error	
FE4	Exhaust fan 1 error	
FE5	Exhaust fan 2 error	
FE6	Color wheel fan error	
FE7	Power supply fan error	
FE8	Ballast fan error	
FJ0	Liquid cooling pump error	<ul style="list-style-type: none"> <li>If the display does not clear after switching the main power off and on, consult your dealer.</li> </ul>

### Note

- The self-test indication and the details of the malfunction may vary.

# Chapter 6 **Appendix**

---

This chapter describes specifications and after-sales service for the projector.

# Technical information

## PJLink protocol

The network function of this projector supports the PJLink class 1, and the PJLink protocol can be used to perform projector setting and projector status query operations from a computer.

### Control commands

The following table lists the PJLink protocol commands that can be used to control the projector.

• x characters in tables are non-specific characters.

Command	Control details	Parameter / return string	Remark		
POWR	Power supply control	0	Standby		
		1	Power on		
POWR?	Power supply status query	0	Standby		
		1	Power on		
		2	Preparing for switching off the projector		
		3	Warm-up		
INPT	Input selection	11	RGB1		
		12	RGB2		
INPT?	Input selection query	31	DVI-D		
		32	HDMI		
		33	DIGITAL LINK		
		34	SDI (Only for PT-DZ780)		
AVMT	Shutter control	30	Shutter function disabled (shutter: open)		
AVMT?	Shutter status query	31	Shutter function enabled (shutter: closed)		
ERST?	Error status query	xxxxxx	1st byte	Indicates fan errors, and returns 0 - 2.	<ul style="list-style-type: none"> <li>• 0 = No error is detected</li> <li>• 1 = Warning</li> <li>• 2 = Error</li> </ul>
			2nd byte	Indicates lamp errors, and returns 0 - 2.	
			3rd byte	Indicates temperature errors, and returns 0 - 2.	
			4th byte	Indicates cover open errors, and returns 0 or 2.	
			5th byte	Indicates filter errors, and returns 0 - 2.	
			6th byte	Indicates other errors, and returns 0 - 2.	
LAMP?	Lamp status query	xxxxxxxxxxxx	1st number (1 - 5 digits): Lamp 1 runtime 2nd number: 0 = Lamp 1 off, 1 = Lamp 1 on 3rd number (1 - 5 digits): Lamp 2 runtime 4th number: 0 = Lamp 2 off, 1 = Lamp 2 on		
INST?	Input selection list query	11 12 31 32 33 34	Only for PT-DZ780		
		11 12 31 32 33	Only for PT-DW750, PT-DX820		
NAME?	Projector name query	xxxxx	Returns the name set in [PROJECTOR NAME] of [NETWORK SETUP].		
INF1?	Manufacturer name query	Panasonic	Returns manufacturer name.		
INF2?	Model name query	DZ780 DW750 DX820	Returns model name.		
INF0?	Other information queries	xxxxx	Returns information such as version number.		
CLSS?	Class information query	1	Returns class for PJLink.		

## PJLink security authentication

The password used for PJLink is the same as that of the password set for web control.

When using the projector without security authentication, do not set a password for web control.

- For specifications related to PJLink, refer to the website of Japan Business Machine and Information System Industries Association.

URL <http://pjlink.jbmia.or.jp/english/>

## Using Art-Net function

Since the network function of the projector supports the Art-Net function, you can control the projector settings with the DMX controller or application software using the Art-Net protocol.

### Channel definition

The following table lists the channel definitions used for controlling the projector with the Art-Net function.

Channel settings can be switched using the [NETWORK] menu → [Art-Net SETUP] → [ON(2.X.X.X)]/[ON(10.X.X.X)]/[ON(MANUAL)] → [CHANNEL SETUP]. (➔ page 141)

The control content assigned to each channel is as the following table.

- Channel assignment for [USER] is in factory setting. Assignment can be changed.

Channel	Control details		
	[DEFAULT]	[USER]	[DZ870/DZ21K]
CHANNEL1	LIGHT OUTPUT	LIGHT OUTPUT	SHUTTER
CHANNEL2	INPUT SELECT	INPUT SELECT	INPUT SELECT
CHANNEL3	LENS POSITION	LENS POSITION	LENS FUNCTION SELECT
CHANNEL4	LENS H SHIFT	LENS H SHIFT	LENS CONTROL
CHANNEL5	LENS V SHIFT	LENS V SHIFT	POWER
CHANNEL6	LENS FOCUS	LENS FOCUS	LIGHT OUTPUT
CHANNEL7	LENS ZOOM	LENS ZOOM	ENABLE / DISABLE
CHANNEL8	POWER	POWER	NONE
CHANNEL9	GEOMETRY	GEOMETRY	NONE
CHANNEL10	CUSTOM MASKING	CUSTOM MASKING	CUSTOM MASKING
CHANNEL11	ENABLE / DISABLE	ENABLE / DISABLE	GEOMETRY
CHANNEL12	NONE	NONE	NONE

### ■ Control content

Control details	Performance	Parameter	Default value	Remark
LIGHT OUTPUT	100 %	0	0	Can be set in 256 steps between 100 % and 0 %.
	...	...		
	0 %	255		
SHUTTER	SHUTTER: Open	0-63	128	—
	No operation	64-191		
	SHUTTER: Close	192-255		
INPUT SELECT (when [DZ870/DZ21K] is selected)	No operation	0-7	0	—
	RGB1	8-15		
	RGB2	16-23		
	No operation	24-31		
	DVI-D	32-39		
	HDMI	40-47		
	DIGITAL LINK	48-55		
	SDI (Only for PT-DZ780)	56-63		
	No operation	64-127		
	P IN P execution, USER1	128-135		
	P IN P execution, USER2	136-143		
	P IN P execution, USER3	144-151		
	No operation	152-255		

Chapter 6 Appendix — Technical information

Control details	Performance	Parameter	Default value	Remark		
INPUT SELECT (when [DEFAULT] or [USER] is selected)	No operation	0-7	0	—		
	RGB1	8-15				
	RGB2	16-23				
	DVI-D	24-31				
	HDMI	32-39				
	DIGITAL LINK	40-47				
	SDI (Only for PT-DZ780)	48-55				
	No operation	56-127				
	Execute P IN P, USER1	128-135				
	Execute P IN P, USER2	136-143				
	Execute P IN P, USER3	144-151				
	No operation	152-255				
LENS POSITION	No operation	0-31	0	“Move to the home position” is an operation when [NORMAL] is selected in [HOME POSITION] of the [HOME POSITION] screen. “Move to the ET-DLE030 standard lens position” is an operation when [DLE030] is selected in [HOME POSITION] of the [HOME POSITION] screen.		
	Move to the home position	32-63				
	Move to the ET-DLE030 standard lens position					
	No operation	64-255				
LENS H SHIFT LENS V SHIFT LENS FOCUS LENS ZOOM	Lens adjustment	(-) High speed	0-31	128	—	
		(-) Low speed	32-63			
		(-) Fine adjustment	64-95			
	Operation stop		96-159			
	Lens adjustment	(+) Fine adjustment	160-191			
		(+) Low speed	192-223			
		(+) High speed	224-255			
LENS FUNCTION SELECT (when [DZ870/DZ21K] is selected)	No operation	0-15	0	Operate together with LENS CONTROL. “Move to the home position” is an operation when [NORMAL] is selected in [HOME POSITION] of the [HOME POSITION] screen. “Move to the ET-DLE030 standard lens position” is an operation when [DLE030] is selected in [HOME POSITION] of the [HOME POSITION] screen.		
	LENS H SHIFT	16-31				
	LENS V SHIFT	32-47				
	LENS FOCUS	48-63				
	LENS ZOOM	64-79				
	Move to the home position	80-95				
	Move to the ET-DLE030 standard lens position					
	No operation	96-255				
LENS CONTROL (when [DZ870/DZ21K] is selected)	Lens adjustment	(-) High speed	0-31	100	Operate together with LENS FUNCTION SELECT.	
		(-) Low speed	32-63			
		(-) Fine adjustment	64-95			
	Operation stop		96-127			
	Lens adjustment	(+) Fine adjustment	128-159			
		(+) Low speed	160-191			
		(+) High speed	192-223			
	Execute command action		224-255			
POWER	Standby	0-63	128	—		
	No operation	64-191				
	Power on	192-255				
CUSTOM MASKING	OFF	0-31	255	(Only for PT-DZ780) To use PC-1, PC-2, and PC-3, the optional Upgrade Kit (Model No.: ET-UK20) is required.		
	PC-1	32-63				
	PC-2	64-95				
	PC-3	96-127				
	No operation	128-255				



Control details	Performance	Parameter	Default value	Remark
GEOMETRY	OFF	0-15	255	To use PC-1, PC-2, and PC-3, the optional Upgrade Kit (Model No.: ET-UK20) is required.
	KEystone	16-31		
	CURVED	32-47		
	PC-1 (Only for PT-DZ780)	48-63		
	PC-2 (Only for PT-DZ780)	64-79		
	PC-3 (Only for PT-DZ780)	80-95		
	CORNER CORRECTION	96-111		
	No operation	112-255		
FREEZE	No operation	0-31	128	—
	OFF	32-95		
	No operation	96-159		
	ON	160-223		
	No operation	224-255		
COLOR TINT	No operation	0-31	0	—
	Factory default setting	32-63		
	-31	64-65		
	...	...		
	0	128-129		
	...	...		
	+31	190-191		
	No operation	192-255		
RASTER PATTERN	No operation	0-15	0	—
	OFF	16-31		
	WHITE	32-47		
	YELLOW	48-63		
	CYAN	64-79		
	GREEN	80-95		
	MAGENTA	96-111		
	RED	112-127		
	BLUE	128-143		
	BLACK	144-159		
	USER LOGO	160-175		
	No operation	176-255		
	ENABLE / DISABLE	Disable		
Enable		128-255		

**Note**

- If the projector is operated with the remote control or on the control panel, or by the control command while controlling the projector using the Art-Net function, the setting of the DMX controller or computer application may be different from the projector status. To reflect the controls of all channels to the projector, set "ENABLE / DISABLE" of channel 11 to "Disable" and then set back to "Enable".
- To create/register the USER LOGO image, use "Logo Transfer Software" included in the supplied CD-ROM.

**Control commands via LAN**

**When web control administrator rights password is set (Protect mode)**

**Connecting**

- 1) Obtain the IP address and port number (Initial set value = 1024) of the projector and request a connection to the projector.
  - You can obtain both the IP address and the port number from the menu screen of the projector.

<b>IP address</b>	Obtain from the [NETWORK] menu → [NETWORK STATUS]
<b>Port number</b>	Obtain from the [NETWORK] menu → [NETWORK CONTROL] → [COMMAND PORT]

- 2) Check the response from the projector.

	Data section	Blank	Mode	Blank	Random number section	Termination symbol
<b>Command example</b>	"NTCONTROL" (ASCII string)	' ' 0x20	'1' 0x31	' ' 0x20	"zzzzzzzz" (ASCII code hex number)	(CR) 0x0d
<b>Data length</b>	9 bytes	1 byte	1 byte	1 byte	8 bytes	1 byte

- Mode: 1 = Protect mode
- Example: Response during protect mode (random number section is undefined value)  
"NTCONTROL 1 23181e1e" (CR)

**3) Generate a 32-byte hash value from the following data using MD5 algorithm.**

- "xxxxxx:yyyyy:zzzzzzzz"

<b>xxxxxx</b>	Administrator rights user name for the web control (default user name is "admin1")
<b>yyyyy</b>	Password of above administrator rights user (default password is "panasonic")
<b>zzzzzzzz</b>	8-byte random number obtained in Step 2)

**Command transmission method**

Transmit using the following command formats.

■ **Transmitted data**

	Header			Data section	Termination symbol
<b>Command example</b>	Hash value (Refer to "Connecting" above)	'0' 0x30	'0' 0x30	Control command (ASCII string)	(CR) 0x0d
<b>Data length</b>	32 bytes	1 byte	1 byte	Undefined length	1 byte

- Example: Transmission of power supply status acquisition command (hash value is calculated from default user name, password, and acquired random number)  
"dbdd2dabd3d4d68c5dd970ec0c29fa6400QPW" (CR)

■ **Received data**

	Header		Data section	Termination symbol
<b>Command example</b>	'0' 0x30	'0' 0x30	Control command (ASCII string)	(CR) 0x0d
<b>Data length</b>	1 byte	1 byte	Undefined length	1 byte

- Example: The projector is powered on  
"00001" (CR)

■ **Error response**

	String	Details	Termination symbol
<b>Message</b>	"ERR1"	Undefined control command	(CR) 0x0d
	"ERR2"	Out of parameter range	
	"ERR3"	Busy state or no-acceptable period	
	"ERR4"	Timeout or no-acceptable period	
	"ERR5"	Wrong data length	
	"ERRA"	Password mismatch	
<b>Data length</b>	4 bytes	—	1 byte

## When web control administrator rights password is not set (Non-protect mode)

### Connecting

#### 1) Obtain the IP address and port number (Initial set value = 1024) of the projector and request a connection to the projector.

- You can obtain both the IP address and the port number from the menu screen of the projector.

<b>IP address</b>	Obtain from the [NETWORK] menu → [NETWORK STATUS]
<b>Port number</b>	Obtain from the [NETWORK] menu → [NETWORK CONTROL] → [COMMAND PORT]

#### 2) Check the response from the projector.

	Data section	Blank	Mode	Termination symbol
<b>Command example</b>	"NTCONTROL" (ASCII string)	' ' 0x20	'0' 0x30	(CR) 0x0d
<b>Data length</b>	9 bytes	1 byte	1 byte	1 byte

- Mode: 0 = Non-protect mode
- Example: Response during non-protect mode  
"NTCONTROL 0" (CR)

### Command transmission method

Transmit using the following command formats.

#### ■ Transmitted data

	Header		Data section	Termination symbol
<b>Command example</b>	'0' 0x30	'0' 0x30	Control command (ASCII string)	(CR) 0x0d
<b>Data length</b>	1 byte	1 byte	Undefined length	1 byte

- Example: Transmission of power supply status acquisition command  
"00QPW" (CR)

#### ■ Received data

	Header		Data section	Termination symbol
<b>Command example</b>	'0' 0x30	'0' 0x30	Control command (ASCII string)	(CR) 0x0d
<b>Data length</b>	1 byte	1 byte	Undefined length	1 byte

- Example: The power of the projector is in standby status  
"00000" (CR)

#### ■ Error response

	String	Details	Termination symbol
<b>Message</b>	"ERR1"	Undefined control command	(CR) 0x0d
	"ERR2"	Out of parameter range	
	"ERR3"	Busy state or no-acceptable period	
	"ERR4"	Timeout or no-acceptable period	
	"ERR5"	Wrong data length	
	"ERRA"	Password mismatch	
<b>Data length</b>	4 bytes	—	1 byte

## <SERIAL IN>/<SERIAL OUT> terminal

The <SERIAL IN>/<SERIAL OUT> terminal of the projector conforms with RS-232C so that the projector can be connected to and controlled from a computer.

### Connection

#### Single projector

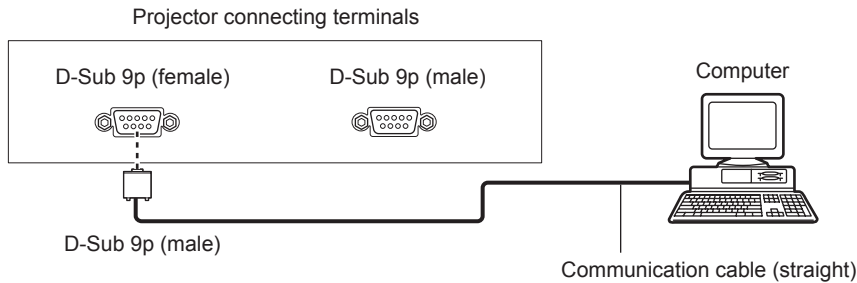

#### Multiple projectors

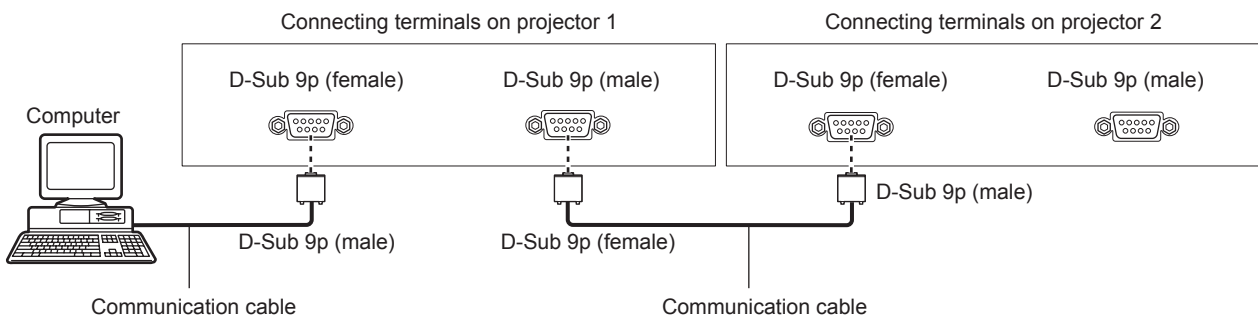

#### To connect to DIGITAL LINK compatible devices

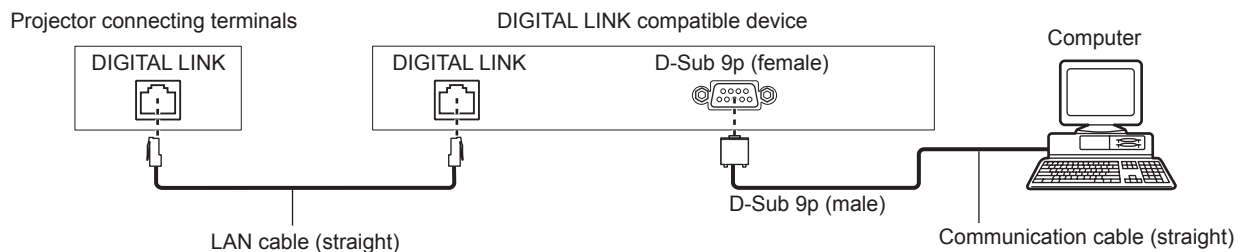

### Note

- The destination of [RS-232C] (➔ page 121) must be set according to the connection method.
- When connecting by a DIGITAL LINK compatible device, set the [PROJECTOR SETUP] menu → [STANDBY MODE] (➔ page 118) setting to [NORMAL] to control the projector during standby.  
When [STANDBY MODE] is set to [ECO], the projector cannot be control during standby.

### Pin assignments and signal names

D-Sub 9-pin (female) Outside view	Pin No.	Signal name	Details
	(1)	—	NC
	(2)	TXD	Transmitted data
	(3)	RXD	Received data
	(4)	—	NC
	(5)	GND	Earth
	(6)	—	NC
	(7)	CTS	Connected internally
	(8)	RTS	
	(9)	—	NC

D-Sub 9-pin (male) Outside view	Pin No.	Signal name	Details
	(1)	—	NC
	(2)	RXD	Received data
	(3)	TXD	Transmitted data
	(4)	—	NC
	(5)	GND	Earth
	(6)	—	NC
	(7)	RTS	Connected internally
	(8)	CTS	
	(9)	—	NC

### Communication conditions (Factory default)

Signal level	RS-232C-compliant
Sync. method	Asynchronous
Baud rate	9 600 bps
Parity	None
Character length	8 bits
Stop bit	1 bit
X parameter	None
S parameter	None

### Basic format

Transmission from the computer starts with STX, then the ID, command, parameter, and ETX are sent in this order. Add parameters according to the details of control.

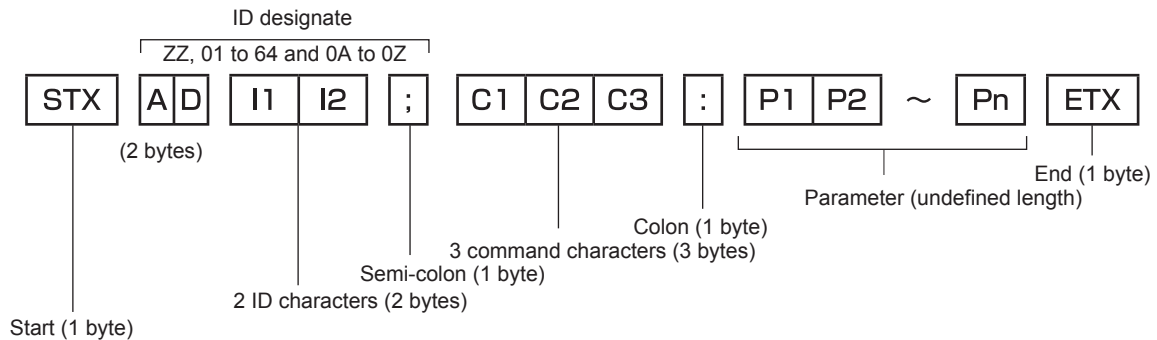

### Basic format (has subcommands)

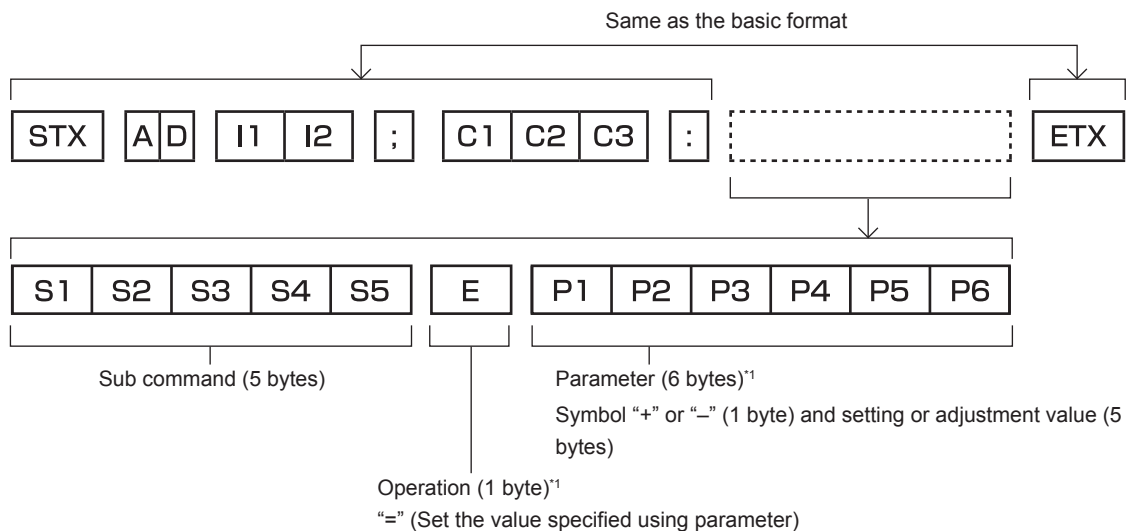

\*1 When transmitting a command which does not need a parameter, an operation (E) and parameter are not necessary.

**Attention**

- If a command is transmitted after the lamp starts illuminating, there may be a delay in response or the command may not be executed. Try sending or receiving any command after 60 seconds.
- When transmitting multiple commands, be sure to wait until 0.5 seconds has elapsed after receiving the response from the projector before sending the next command. When transmitting a command which does not need a parameter, a colon (:) is not necessary.

**Note**

- If a command cannot be executed, the “ER401” response is sent from the projector to the computer.
- If an invalid parameter is sent, the “ER402” response is sent from the projector to the computer.
- ID transmission in RS-232C supports ZZ (ALL) and 01 to 64, as well as 0A to 0Z groups.
- If a command is sent with a specified ID, a response will be sent to the computer only in the following cases.
  - It matches the projector ID
  - ID setting is set to ALL and [RESPONSE(ID ALL)] is [ON]
  - ID setting is set to GROUP and [RESPONSE(ID GROUP)] is [ON]
- STX and ETX are character codes. STX shown in hexadecimal is 02, and ETX shown in hexadecimal is 03.

**When multiple projectors are controlled**

**When multiple projectors are all controlled**

When controlling multiple projectors together via RS-232C, perform the following settings.

- 1) Set a different ID for each projector.
- 2) Set [RESPONSE(ID ALL)] to [ON] in only one projector.
- 3) Set [RESPONSE(ID ALL)] to [OFF] for all other projectors set in Step 2).

**When multiple projectors are all controlled by group unit**

When controlling multiple projectors by group unit via RS-232C, perform the following settings.

- 1) Set a different ID for each projector.
- 2) Set [RESPONSE(ID GROUP)] to [ON] in only one projector.
- 3) Set [RESPONSE(ID GROUP)] to [OFF] for all other projectors set in Step 2).

**Note**

- There will be no response if two or more projectors have [RESPONSE(ID ALL)] set to [ON].
- There will be no response if two or more projectors of the same group have [RESPONSE(ID GROUP)] set to [ON].
- When setting multiple groups, set [RESPONSE(ID ALL)] to [ON] in only one projector in each group.

**Cable specification**

**When connected to a computer**

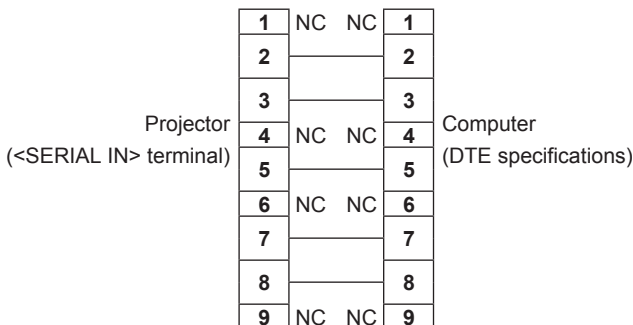

**When multiple projectors are connected**

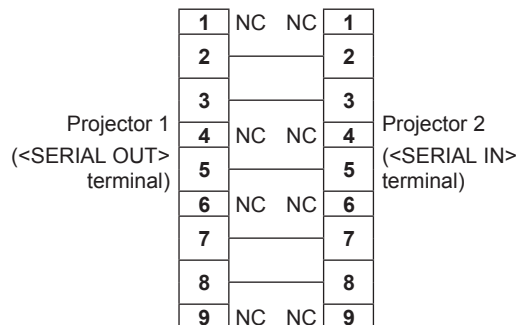

## Control command

The following table lists the commands that can be used to control the projector using a computer.

### ■ Projector control command

Command	Details	Parameter/response string	Remark (parameter)
PON	Power on	—	To check if the power is on, use the “Power query” command.
POF	Power standby		
QPW	Power query	000 001	STANDBY Power on
IIS	Switching the input signal	RG1 RG2 DVI HD1 DL1 SD1	RGB1 RGB2 DVI-D HDMI DIGITAL LINK SDI (Only for PT-DZ780)
QSL	Query for lamp selection	0 1 2 3	DUAL SINGLE LAMP1 LAMP2
LPM	Lamp selection	0 1 2 3	DUAL SINGLE*1 LAMP1 LAMP2
Q\$L	Query for lamp runtime	1 2	LAMP1 LAMP2 Response is 0000 to 4000
OLP	Lamp power	0 1	NORMAL ECO
OSH	Shutter control	0	OPEN
QSH	Shutter status query	1	CLOSE
VSE	Aspect ratio switch	0 1 2 5	DEFAULT/VID AUTO 4:3 16:9 THROUGH
QSE	Aspect ratio settings query	6 9 10	HV FIT H FIT V FIT
OPP	P IN P execution	0 1	OFF USER1
QPP	P IN P setting query	2 3	USER2 USER3
OCS	Sub memory switch	01 - 96	Sub memory number
QSB	Sub memory status query		

\*1 The lamp 1 or the lamp 2, whichever has a shorter runtime, is used.

### ■ Projector control command (with sub command)

Command	Sub command	Details	Remark
VXX	RYC11	RGB1 input setting	+00000=RGB/YP <sub>B</sub> P <sub>R</sub> , +00001=Y/C, +00002=VIDEO

### ■ Lens control command

Command	Sub command	Details	Remark
VXX	LNSI2	Lens H shift	+00000 = Fine adjustment 1+, +00001 = Fine adjustment 1-, +00100 = Fine adjustment 2+, +00101 = Fine adjustment 2-, +00200 = Coarse adjustment+, +00201 = Coarse adjustment-
VXX	LNSI3	Lens V shift	
VXX	LNSI4	Lens focus	
VXX	LNSI5	Lens zoom	

## <REMOTE 2 IN> terminal

It is possible to control the projector remotely (by external contact) from a control panel located away from the projector where remote control signals cannot reach.

Use the <REMOTE 2 IN> terminal on the connecting terminals of the projector to connect to the control panel.

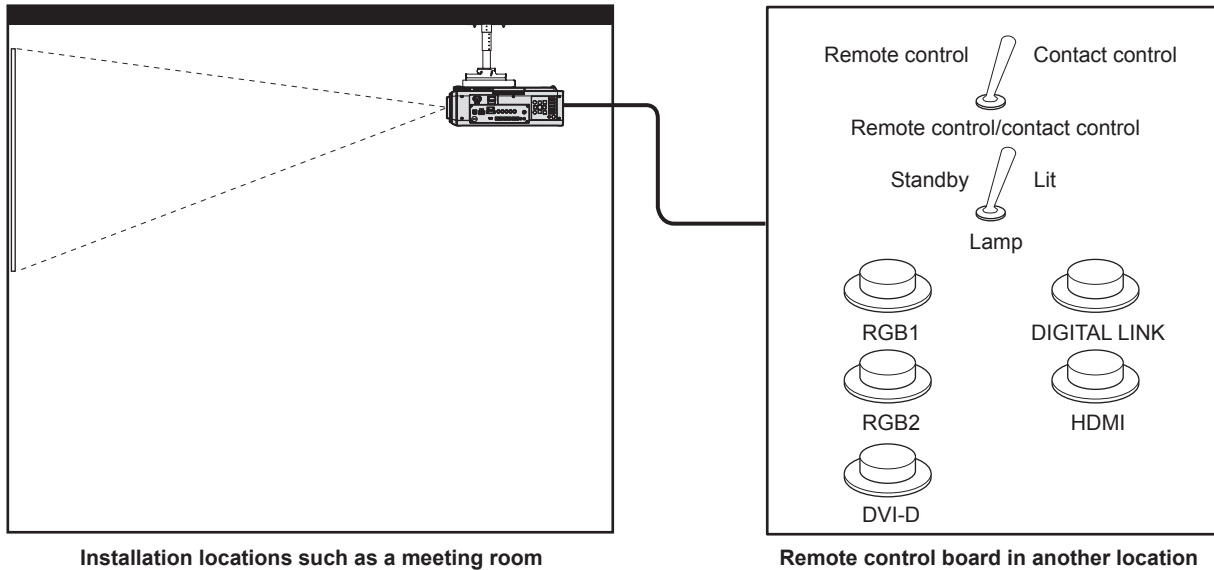

Installation locations such as a meeting room

Remote control board in another location

## Pin assignments and signal names

D-Sub 9-pin Outside view	Pin No.	Signal name	Open (H)	Short (L)
	(1)	GND	—	GND
	(2)	POWER	OFF	ON
	(3)	RGB1	Other	RGB1
	(4)	RGB2	Other	RGB2
	(5)	DIGITAL LINK	Other	DIGITAL LINK
	(6)	HDMI	Other	HDMI
	(7)	DVI-D	Other	DVI-D
	(8)	SHUTTER	OFF	ON
	(9)	RST/SET	Controlled by remote control	Controlled by external contact

### Attention

- When controlling, make sure to short-circuit pins (1) and (9).
- When pins (1) and (9) are short-circuited, the following buttons on the control panel and the remote control are disabled. Commands for RS-232C and network functions corresponding to these functions are also disabled.
  - Power on <|> button, power standby <ϕ> button, <SHUTTER> button
- When pins (1) and (9) are short-circuited, and then any pins from (3) to (7) and the pin (1) are short-circuited, the following buttons on the control panel and the remote control are disabled. Commands for RS-232C and network functions corresponding to these functions are also disabled.
  - Power on <|> button, power standby <ϕ> button, <RGB1> button, <RGB2> button, <RGB1/2> button, <DVI-D> button, <VIDEO> button, <HDMI> button, <DIGITAL LINK> button, <SDI> button, <SHUTTER> button (SDI input is supported only for PT-DZ780.)

### Note

- For pin (2) to pin (8) settings, you can make changes if you set [REMOTE2 MODE] to [USER]. (➔ page 124)



## Two-window display combination list

✓: P IN P (picture in picture) combination is possible

▲: P IN P (picture in picture) combination is possible through the same frequency signal

—: P IN P (picture in picture) combination is not possible

Main window		Sub window					
		RGB1				RGB2	
		RGB	Movie <sup>*1</sup>	Y/C input	VIDEO input	RGB	Movie <sup>*1</sup>
RGB1	RGB	—	—	—	—	✓	✓
	Movie <sup>*1</sup>	—	—	—	—	✓	▲
	Y/C input	—	—	—	—	✓	▲
	VIDEO input	—	—	—	—	✓	▲
RGB2	RGB	✓	✓	✓	✓	—	—
	Movie <sup>*1</sup>	✓	▲	▲	▲	—	—
DVI-D	RGB <sup>*2</sup>	✓	✓	✓	✓	✓	✓
	Movie <sup>*3</sup>	✓	▲	▲	▲	✓	▲
HDMI	RGB <sup>*2</sup>	✓	✓	✓	✓	✓	✓
	Movie <sup>*3</sup>	✓	▲	▲	▲	✓	▲
SDI <sup>*4</sup>		✓	▲	▲	▲	✓	▲
DIGITAL LINK	RGB <sup>*2</sup>	—	—	—	—	—	—
	Movie <sup>*3</sup>	—	—	—	—	—	—

Main window		Sub window						
		DVI-D		HDMI		SDI <sup>*4</sup>	DIGITAL LINK	
		RGB <sup>*2</sup>	Movie <sup>*3</sup>	RGB <sup>*2</sup>	Movie <sup>*3</sup>		RGB <sup>*2</sup>	Movie <sup>*3</sup>
RGB1	RGB	✓	✓	✓	✓	✓	—	—
	Movie <sup>*1</sup>	✓	▲	✓	▲	▲	—	—
	Y/C input	✓	▲	✓	▲	▲	—	—
	VIDEO input	✓	▲	✓	▲	▲	—	—
RGB2	RGB	✓	✓	✓	✓	✓	—	—
	Movie <sup>*1</sup>	✓	▲	✓	▲	▲	—	—
DVI-D	RGB <sup>*2</sup>	—	—	✓	✓	✓	—	—
	Movie <sup>*3</sup>	—	—	✓	▲	▲	—	—
HDMI	RGB <sup>*2</sup>	✓	✓	—	—	—	—	—
	Movie <sup>*3</sup>	✓	▲	—	—	—	—	—
SDI <sup>*4</sup>		✓	▲	—	—	—	—	—
DIGITAL LINK	RGB <sup>*2</sup>	—	—	—	—	—	—	—
	Movie <sup>*3</sup>	—	—	—	—	—	—	—

\*1 480i, 480p, 576i, 576p, 720/60p, 720/50p, 1080/60i, 1080/50i, 1080/24sF, 1080/24p, 1080/25p, 1080/30p, 1080/50p, 1080/60p

\*2 VGA (640 x 480) - WUXGA (1 920 x 1 200)

Non-interlace signal, dot clock frequency: 25 MHz to 162 MHz (The WUXGA signal is only compatible with VESA CVT RB (Reduced Blanking) signals.)

\*3 Only supports 480p, 576p, 720/60p, 720/50p, 1080/60i, 1080/50i, 1080/24sF, 1080/24p, 1080/25p, 1080/30p, 1080/50p, and 1080/60p

\*4 Only for PT-DZ780

### Note

- In the combination of ▲, if P IN P function is used with the signals of a different frequency, images in the sub window will not be displayed.

## Control device password

To initialize your password, consult your distributor.

## Upgrade Kit

(Only for PT-DZ780)

If the optional Upgrade Kit (Model No.: ET-UK20) is applied, the following functions are extended.

Function	Standard status	When the Upgrade Kit is applied
Adjustment range of [VERTICAL KEYSTONE]	Maximum of $\pm 40^{\circ*1}$	Maximum of $\pm 45^{\circ*1}$
Adjustment range of [HORIZONTAL KEYSTONE]	Maximum of $\pm 15^{\circ*1}$	Maximum of $\pm 40^{\circ*1}$
Adjustment range of [CURVED]	Vertical arc, Maximum $\pm 50^{\circ*1}$ Horizontal arc, Maximum $\pm 50^{\circ*1}$	Vertical arc, Maximum $\pm 100^{\circ*1}$ Horizontal arc, Maximum $\pm 100^{\circ*1}$
[CUSTOM MASKING]	Cannot be used.	The image is masked in optional form.
[PC CORRECTION] of [UNIFORMITY]	Cannot be used.	Correct the brightness and color unevenness of the entire screen.

\*1 The adjustment range of the menu. Refer to "[GEOMETRY] projection range" (➔ page 34) for the possible projection range.

## List of compatible signals

The following table specifies the video signals compatible with the projector.

• Symbols that indicate formats are as follows.

- V: VIDEO, Y/C
- R: RGB
- Y:  $Y C_B C_R / Y P_B P_R$
- D: DVI-D
- H: HDMI
- S: SDI (Only for PT-DZ780)

Mode	Resolution (Dots)	Scanning freq.		Dot clock freq. (MHz)	Format	Plug and play*1			
		Horizontal (kHz)	Vertical (Hz)			RGB2	DVI-D		
						EDID1	EDID2	EDID3	
NTSC/NTSC4.43/ PAL-M/PAL60	720 x 480i	15.7	59.9	—	V	—	—	—	—
PAL/PAL-N/SECAM	720 x 576i	15.6	50.0	—	V	—	—	—	—
525i (480i)	720 x 480i	15.7	59.9	13.5	R/Y/S	—	—	—	—
625i (576i)	720 x 576i	15.6	50.0	13.5	R/Y/S	—	—	—	—
525i (480i)	720 (1440) x 480i*2	15.7	59.9	27.0	D/H	—	—	—	—
625i (576i)	720 (1440) x 576i*2	15.6	50.0	27.0	D/H	—	—	—	—
525p (480p)	720 x 483	31.5	59.9	27.0	R/Y/D/H	—	✓	—	✓
625p (576p)	720 x 576	31.3	50.0	27.0	R/Y/D/H	—	✓	—	✓
750 (720)/60p	1 280 x 720	45.0	60.0	74.3	R/Y/D/H/S	—	✓	—	✓
750 (720)/50p	1 280 x 720	37.5	50.0	74.3	R/Y/D/H/S	—	✓	—	✓
1125 (1080)/60i*3	1 920 x 1 080i	33.8	60.0	74.3	R/Y/D/H/S	—	✓	—	✓
1125 (1080)/50i	1 920 x 1 080i	28.1	50.0	74.3	R/Y/D/H/S	—	✓	—	✓
1125 (1080)/24p	1 920 x 1 080	27.0	24.0	74.3	R/Y/D/H/S	—	✓	—	✓
1125 (1080)/24sF	1 920 x 1 080i	27.0	48.0	74.3	R/Y/D/H/S	—	—	—	—
1125 (1080)/25p	1 920 x 1 080	28.1	25.0	74.3	R/Y/D/H/S	—	✓	—	✓
1125 (1080)/30p	1 920 x 1 080	33.8	30.0	74.3	R/Y/D/H/S	—	—	—	—
1125 (1080)/60p	1 920 x 1 080	67.5	60.0	148.5	R/Y/D/H/S	—	✓	—	✓
1125 (1080)/50p	1 920 x 1 080	56.3	50.0	148.5	R/Y/D/H/S	—	✓	—	✓
VESA400	640 x 400	31.5	70.1	25.2	R/D/H	—	—	—	—
	640 x 400	37.9	85.1	31.5	R/D/H	—	—	—	—
VGA480	640 x 480	31.5	59.9	25.2	R/D/H	✓	✓	✓	✓
	640 x 480	35.0	66.7	30.2	R/D/H	—	—	—	—
	640 x 480	37.9	72.8	31.5	R/D/H	✓	—	✓	✓
	640 x 480	37.5	75.0	31.5	R/D/H	✓	—	✓	✓
	640 x 480	43.3	85.0	36.0	R/D/H	—	—	—	—

Chapter 6 Appendix — Technical information

Mode	Resolution (Dots)	Scanning freq.		Dot clock freq. (MHz)	Format	Plug and play <sup>*1</sup>				
		Horizontal (kHz)	Vertical (Hz)			RGB2	DVI-D			HDMI
							EDID1	EDID2	EDID3	
SVGA	800 x 600	35.2	56.3	36.0	R/D/H	✓	—	✓	✓	✓
	800 x 600	37.9	60.3	40.0	R/D/H	✓	—	✓	✓	✓
	800 x 600	48.1	72.2	50.0	R/D/H	✓	—	✓	✓	✓
	800 x 600	46.9	75.0	49.5	R/D/H	✓	—	✓	✓	✓
	800 x 600	53.7	85.1	56.3	R/D/H	—	—	—	—	—
MAC16	832 x 624	49.7	74.6	57.3	R/D/H	✓	—	✓	✓	✓
XGA	1 024 x 768	39.6	50.0	51.9	R/D/H	—	—	—	—	—
	1 024 x 768	48.4	60.0	65.0	R/D/H	✓	—	✓	✓	✓
	1 024 x 768	56.5	70.1	75.0	R/D/H	✓	—	✓	✓	✓
	1 024 x 768	60.0	75.0	78.8	R/D/H	✓	—	✓	✓	✓
	1 024 x 768	65.5	81.6	86.0	R/D/H	—	—	—	—	—
	1 024 x 768	68.7	85.0	94.5	R/D/H	—	—	—	—	—
	1 024 x 768	81.4	100.0	113.3	R/D/H	—	—	—	—	—
MXGA	1 152 x 864	53.7	60.0	81.6	R/D/H	—	—	—	—	—
	1 152 x 864	64.0	70.0	94.2	R/D/H	—	—	—	—	—
	1 152 x 864	67.5	74.9	108.0	R/D/H	—	—	—	—	—
	1 152 x 864	77.1	85.0	119.7	R/D/H	—	—	—	—	—
MAC21	1 152 x 870	68.7	75.1	100.0	R/D/H	✓	—	✓	✓	✓
1280 x 720	1 280 x 720	37.1	49.8	60.5	R/D/H	—	—	—	—	—
	1 280 x 720	44.8	59.9	74.5	R/D/H	—	—	—	—	—
	1 280 x 720	76.3	100.0	131.8	R/D/H	—	—	—	—	—
	1 280 x 720	92.6	120.0	161.6	R/D/H	—	—	—	—	—
1280 x 768	1 280 x 768	39.6	49.9	65.3	R/D/H	—	—	—	—	—
	1 280 x 768	47.8	59.9	79.5	R/D/H	—	—	—	—	—
	1 280 x 768 <sup>*4</sup>	47.4	60.0	68.3	R/D/H	—	—	—	—	—
	1 280 x 768	60.3	74.9	102.3	R/D/H	—	—	—	—	—
	1 280 x 768	68.6	84.8	117.5	R/D/H	—	—	—	—	—
1280 x 800	1 280 x 800	41.3	50.0	68.0	R/D/H	—	—	—	—	—
	1 280 x 800	49.7	59.8	83.5	R/D/H	✓ <sup>*5</sup>	—	✓ <sup>*5</sup>	✓ <sup>*5</sup>	✓ <sup>*5</sup>
	1 280 x 800 <sup>*4</sup>	49.3	59.9	71.0	R/D/H	—	—	—	—	—
	1 280 x 800	62.8	74.9	106.5	R/D/H	—	—	—	—	—
	1 280 x 800	71.6	84.9	122.5	R/D/H	—	—	—	—	—
MSXGA	1 280 x 960	60.0	60.0	108.0	R/D/H	—	—	—	—	—
SXGA	1 280 x 1 024	52.4	50.0	88.0	R/D/H	—	—	—	—	—
	1 280 x 1 024	64.0	60.0	108.0	R/D/H	—	—	—	—	—
	1 280 x 1 024	72.3	66.3	125.0	R/D/H	—	—	—	—	—
	1 280 x 1 024	78.2	72.0	135.1	R/D/H	—	—	—	—	—
	1 280 x 1 024	80.0	75.0	135.0	R/D/H	✓	—	✓	✓	✓
	1 280 x 1 024	91.1	85.0	157.5	R/D/H	—	—	—	—	—
1366 x 768	1 366 x 768	47.7	59.8	85.5	R/D/H	—	—	—	—	—
	1 366 x 768	39.6	49.9	69.0	R/D/H	—	—	—	—	—
SXGA+	1 400 x 1 050	54.1	50.0	99.9	R/D/H	—	—	—	—	—
	1 400 x 1 050	64.0	60.0	108.0	R/D/H	—	—	—	—	—
	1 400 x 1 050	65.2	60.0	122.6	R/D/H	✓	—	✓	✓	✓
	1 400 x 1 050	65.3	60.0	121.8	R/D/H	—	—	—	—	—
	1 400 x 1 050	78.8	72.0	149.3	R/D/H	—	—	—	—	—
	1 400 x 1 050	82.2	75.0	155.9	R/D/H	—	—	—	—	—
WXGA+	1 440 x 900	55.9	59.9	106.5	R/D/H	—	—	—	—	—
	1 440 x 900	46.3	49.9	86.8	R/D/H	—	—	—	—	—
1600 x 900	1 600 x 900	46.4	49.9	96.5	R/D/H	—	—	—	—	—
	1 600 x 900	55.9	60.0	119.0	R/D/H	✓	—	✓	✓	✓
UXGA	1 600 x 1 200	61.8	49.9	131.5	R/D/H	—	—	—	—	—
	1 600 x 1 200	75.0	60.0	162.0	R/D/H	✓	—	✓	✓	✓

## Chapter 6 Appendix — Technical information

Mode	Resolution (Dots)	Scanning freq.		Dot clock freq. (MHz)	Format	Plug and play*1				
		Horizontal (kHz)	Vertical (Hz)			RGB2	DVI-D			HDMI
							EDID1	EDID2	EDID3	
WSXGA+	1 680 x 1 050	65.3	60.0	146.3	R/D/H	—	—	—	—	—
	1 680 x 1 050	54.1	50.0	119.5	R/D/H	—	—	—	—	—
1920 x 1080	1 920 x 1 080	55.6	49.9	141.5	R/D/H	—	—	—	—	—
	1 920 x 1 080*4	66.6	59.9	138.5	R/D/H	—	—	—	—	—
	1 920 x 1 080*6	67.2	60.0	173.0	R	—	—	—	—	—
WUXGA	1 920 x 1 200	61.8	49.9	158.3	R/D/H	—	—	—	—	—
	1 920 x 1 200*4	74.0	60.0	154.0	R/D/H	✓	—	✓	✓*7	✓*7
	1 920 x 1 200*6	74.6	59.9	193.3	R	—	—	—	—	—

\*1 Signals with a ✓ in the Plug and play columns are signals described in EDID (extended display identification data) of the projector. If a signal has no ✓ in the Plug and play columns but has an entry in the Format column, it can be input. For signals without a ✓ in the Plug and play columns, there are instances when resolution cannot be selected on the computer even though the projector supports them.

\*2 Pixel-Repetition signal (dot clock frequency 27.0 MHz) only

\*3 When a 1125 (1035)/60i signal was input, it is displayed as a 1125 (1080)/60i signal.

\*4 VESA CVT-RB (Reduced Blanking)-compliant

\*5 Only for PT-DW750

\*6 Samples the pixels in the image processing circuit and projects the image.

\*7 Only for PT-DZ780

### Note

- The display dot for PT-DZ780 is 1 920 x 1 200, the display dot for PT-DW750 is 1 280 x 800, and the display dot for PT-DX820 is 1 024 x 768. A signal with a different resolution is converted to the number of display dots.
- The "i" at the end of the resolution indicates an interlaced signal.
- When interlaced signals are connected, flickering may occur on the projected image.
- DIGITAL LINK input compatible signal is the same as HDMI input compatible signal.

# Specifications

The specifications of the projector are as follows.

Power supply	PT-DZ780B, PT-DZ780W, PT-DZ780LB, PT-DZ780LW, PT-DW750B, PT-DW750W, PT-DW750LB, PT-DW750LW, PT-DX820B, PT-DX820W, PT-DX820LB, PT-DX820LW		100 V - 240 V ~ (100 V - 240 V alternating current), 50 Hz/60 Hz (9.0 A - 4.0 A)
	PT-DZ780BD, PT-DZ780WD, PT-DZ780LBD, PT-DZ780LWD, PT-DW750BD, PT-DW750WD, PT-DW750LBD, PT-DW750LWD		
	PT-DZ780BT, PT-DW750BT, PT-DX820BT		110 V ~ (110 V alternating current), 60 Hz (8.0 A)
Power consumption	PT-DZ780B, PT-DZ780W, PT-DZ780LB, PT-DZ780LW, PT-DW750B, PT-DW750W, PT-DW750LB, PT-DW750LW, PT-DX820B, PT-DX820W, PT-DX820LB, PT-DX820LW		790 W
	PT-DZ780BD, PT-DZ780WD, PT-DZ780LBD, PT-DZ780LWD, PT-DW750BD, PT-DW750WD, PT-DW750LBD, PT-DW750LWD		
	PT-DZ780BT, PT-DW750BT, PT-DX820BT		785 W
	PT-DZ780B, PT-DZ780W, PT-DZ780LB, PT-DZ780LW, PT-DW750B, PT-DW750W, PT-DW750LB, PT-DW750LW, PT-DX820B, PT-DX820W, PT-DX820LB, PT-DX820LW		Approx. 0.3 W when [STANDBY MODE] is set to [ECO]
	PT-DZ780BD, PT-DZ780WD, PT-DZ780LBD, PT-DZ780LWD, PT-DW750BD, PT-DW750WD, PT-DW750LBD, PT-DW750LWD		Approx. 0.2 W when [STANDBY MODE] is set to [ECO]
	PT-DZ780BT, PT-DW750BT, PT-DX820BT		Approx. 0.2 W when [STANDBY MODE] is set to [ECO]
Approx. 3 W when [STANDBY MODE] is set to [NORMAL]			
DLP chip	Size	PT-DZ780	17 mm (0.67") (aspect ratio 16:10)
		PT-DW750	16.5 mm (0.65") (aspect ratio 16:10)
		PT-DX820	17.8 mm (0.7") (aspect ratio 4:3)
	Display system	1-unit DLP chip, DLP type	
	Number of pixels	PT-DZ780	2 304 000 pixels (1 920 x 1 200 dots)
		PT-DW750	1 024 000 pixels (1 280 x 800 dots)
PT-DX820		786 432 pixels (1 024 x 768 dots)	
Lens*1	Electric zoom	PT-DZ780	1.7 - 2.4:1
		PT-DW750, PT-DX820	1.8 - 2.5:1
	Electric focus	F = 1.7 - 1.9 f = 25.6 mm - 35.7 mm	
Luminous lamp	310 W UHM lamp x 2		
Light output*2,3	PT-DZ780, PT-DW750	7 000 lm (ANSI)	
	PT-DX820	8 200 lm (ANSI)	
Contrast ratio*3	PT-DZ780, PT-DW750	3 000:1	
	PT-DX820	2 400:1	
Color system	7 standards (NTSC/NTSC4.43/PAL/PAL-N/PAL-M/SECAM/PAL60)		
Projected image size*4	1.27 m (50") to 15.24 m (600")		
Image aspect ratio	PT-DZ780, PT-DW750	16:10	
	PT-DX820	4:3	
Projection method	[FRONT/CEILING], [FRONT/FLOOR], [REAR/CEILING], [REAR/FLOOR]		
Power cable length	3.0 m (118-1/8")		
Outer case	Molded plastic		
Outer color	White model	White	
	Black model	Black	

\*1 The lens for PT-DZ780L series, PT-DW750L series, and PT-DX820L series is sold separately.

\*2 Value is for the supplied standard zoom lens. The value varies depending on the lens.

\*3 Measurement, measuring conditions and method of notation all comply with ISO21118 international standards.

\*4 When the lens ET-DLE055 is used, the maximum size is 5.08 m (200"). When the lens ET-DLE030 is used, the maximum size is 2.54 m (100") to 8.89 m (350").

## Chapter 6 Appendix — Specifications

<b>Dimensions</b>	<b>Width</b>	498 mm (19-19/32")	
	<b>Height</b>	175 mm (6-7/8") (with legs at shortest position)	
	<b>Depth</b>	<b>PT-DZ780, PT-DW750, PT-DX820</b>	521 mm (20-1/2") (including standard zoom lens)
<b>PT-DZ780L, PT-DW750L, PT-DX820L</b>		498 mm (19-19/32") (excluding lens mount cover and optional lens)	
<b>Weight</b>	<b>PT-DZ780, PT-DW750, PT-DX820</b>	Approx. 17.8 kg (39.3 lbs.) <sup>*1</sup> (including standard zoom lens)	
	<b>PT-DZ780L, PT-DW750L, PT-DX820L</b>	Approx. 17.0 kg (37.5 lbs.) <sup>*1</sup> (excluding lens mount cover and optional lens)	
<b>Noise level<sup>*2</sup></b>		30 dB	
<b>Operating environment</b>	<b>Operating environment temperature<sup>*3</sup></b>	0 °C (32 °F) to 45 °C (113 °F)	
	<b>Operating environment humidity</b>	10 % to 80 % (no condensation)	
<b>Remote control</b>	<b>Power supply</b>	DC 3 V (AAA/R03 battery x 2)	
	<b>Operating range</b>	Within approx. 30 m (98'5") (when operated directly in front of signal receiver)	
	<b>Weight</b>	102 g (3.6 ozs.) (including batteries)	
	<b>Dimensions</b>	Width: 48 mm (1-7/8"), Height: 145 mm (5-23/32"), Depth: 27 mm (1-1/16")	

\*1 Average value. Weight varies for each product.

\*2 Measurement, measuring conditions and method of notation all comply with ISO21118 international standards.

\*3 When using the projector at high altitudes (between 1 400 m (4 593') and 2 700 m (8 858') above sea level), the operating environment temperature should be between 0 °C (32 °F) and 40 °C (104 °F).

If the [PROJECTOR SETUP] menu → [LAMP SELECT] is set to [DUAL], and [LAMP POWER] is set to [NORMAL], the light output may be reduced by approximately 20 % to protect the projector when the operating environment temperature becomes 40 °C (104 °F) or higher (35 °C (95 °F) or higher when using the projector at high altitudes).

■ **Applicable scanning frequency**

Refer to “List of compatible signals” (➔ page 186) for the types of video signals that can be used with the projector.

<b>For video signal</b>	Horizontal: 15.73 kHz, Vertical: 59.94 Hz; Horizontal: 15.63 kHz, Vertical: 50 Hz	
<b>For Y/C signal</b>	Horizontal: 15 kHz to 100 kHz, Vertical: 24 Hz to 120 Hz PIAS (Panasonic Intelligent Auto Scanning) system	
<b>For RGB signal</b>	<ul style="list-style-type: none"> <li>• Dot clock frequency: 162 MHz or less</li> </ul>	
<b>For YC<sub>B</sub>C<sub>R</sub>/YP<sub>B</sub>P<sub>R</sub> signal</b>	<ul style="list-style-type: none"> <li>• 525i (480i) Horizontal: 15.73 kHz, Vertical: 59.94 Hz</li> <li>• 525p (480p) Horizontal: 31.47 kHz, Vertical: 59.94 Hz</li> <li>• 750 (720)/60p Horizontal: 45 kHz, Vertical: 60 Hz</li> <li>• 1125 (1035)/60i Horizontal: 33.75 kHz, Vertical: 60 Hz</li> <li>• 1125 (1080)/50i Horizontal: 28.13 kHz, Vertical: 50 Hz</li> <li>• 1125 (1080)/24sF Horizontal: 27 kHz, Vertical: 48 Hz</li> <li>• 1125 (1080)/30p Horizontal: 33.75 kHz, Vertical: 30 Hz</li> <li>• 1125 (1080)/50p Horizontal: 56.25 kHz, Vertical: 50 Hz</li> <li>• The SYNC/HD and VD terminals do not support 3 value SYNC.</li> </ul>	<ul style="list-style-type: none"> <li>• 625i (576i) Horizontal: 15.63 kHz, Vertical: 50 Hz</li> <li>• 625p (576p) Horizontal: 31.25 kHz, Vertical: 50 Hz</li> <li>• 750 (720)/50p Horizontal: 37.5 kHz, Vertical: 50 Hz</li> <li>• 1125 (1080)/60i Horizontal: 33.75 kHz, Vertical: 60 Hz</li> <li>• 1125 (1080)/24p Horizontal: 27 kHz, Vertical: 24 Hz</li> <li>• 1125 (1080)/25p Horizontal: 28.13 kHz, Vertical: 25 Hz</li> <li>• 1125 (1080)/60p Horizontal: 67.5 kHz, Vertical: 60 Hz</li> </ul>
<b>For DVI-D signal</b>	525i (480i)*1, 625i (576i)*1, 525p (480p), 625p (576p), 750 (720)/60p, 750 (720)/50p, 1125 (1080)/60i, 1125 (1080)/50i, 1125 (1080)/24p, 1125 (1080)/24sF, 1125 (1080)/25p, 1125 (1080)/30p, 1125 (1080)/60p, 1125 (1080)/50p <ul style="list-style-type: none"> <li>• Displayable resolution: VGA to WUXGA (non-interlaced)</li> <li>• Dot clock frequency: 25 MHz to 162 MHz</li> </ul>	
<b>For HDMI signal</b>	525i (480i)*1, 625i (576i)*1, 525p (480p), 625p (576p), 750 (720)/60p, 750 (720)/50p, 1125 (1080)/60i, 1125 (1080)/50i, 1125 (1080)/24p, 1125 (1080)/24sF, 1125 (1080)/25p, 1125 (1080)/30p, 1125 (1080)/60p, 1125 (1080)/50p <ul style="list-style-type: none"> <li>• Displayable resolution: VGA to WUXGA (non-interlaced)</li> <li>• Dot clock frequency: 25 MHz to 162 MHz</li> </ul>	
<b>For SDI signal</b> (Only for PT-DZ780)	<b>SD-SDI signal</b>  <b>Single link HD-SDI signal</b>  <b>3G-SDI signal</b>	SMPTE ST 259 compliant YC <sub>B</sub> C <sub>R</sub> 4:2:2 10-bit 480i, 576i  SMPTE ST 292 compliant YP <sub>B</sub> P <sub>R</sub> 4:2:2 10-bit 720/50p, 720/60p, 1035/60i, 1080/50i, 1080/60i, 1080/25p, 1080/24p, 1080/24sF, 1080/30p  SMPTE ST 424 compliant YP <sub>B</sub> P <sub>R</sub> 4:2:2 10-bit 1080/50p, 1080/60p RGB 4:4:4 12-bit/10-bit 1080/50i, 1080/60i, 1080/25p, 1080/24p, 1080/24sF, 1080/30p

\*1 Pixel-Repetition signal (dot clock frequency 27.0 MHz) only

**Note**

- DIGITAL LINK input compatible signal is the same as HDMI input compatible signal.

■ Terminal

<b>&lt;RGB 1 IN&gt; terminal</b>	<p>1 set (BNC x 5 (RGB/YP<sub>B</sub>P<sub>R</sub>/YC<sub>B</sub>C<sub>R</sub>/YC/VIDEO x 1))</p> <p><b>RGB signal</b> 0.7 V [p-p] 75 Ω (SYNC ON GREEN: 1.0 V [p-p] 75 Ω)            SYNC/HD TTL high impedance, automatic positive/negative polarity compatible            VD TTL high impedance, automatic positive/negative polarity compatible</p> <p><b>YP<sub>B</sub>P<sub>R</sub> signal</b> Y: 1.0 V [p-p] including synchronization signal, P<sub>B</sub>P<sub>R</sub>: 0.7 V [p-p] 75 Ω</p> <p><b>Y/C signal</b> Y: 1.0 V [p-p], C: 0.286 V [p-p] 75 Ω</p> <p><b>VIDEO signal</b> BNC: 1.0 V [p-p], 75 Ω</p>
<b>&lt;RGB 2 IN&gt; terminal</b>	<p>1 set, high-density D-Sub 15 p (female)</p> <p><b>RGB signal</b> 0.7 V [p-p] 75 Ω (SYNC ON GREEN: 1.0 V [p-p] 75 Ω)            SYNC/HD TTL high impedance, automatic positive/negative polarity compatible            VD TTL high impedance, automatic positive/negative polarity compatible</p> <p><b>YP<sub>B</sub>P<sub>R</sub> signal</b> Y: 1.0 V [p-p] including synchronization signal, P<sub>B</sub>P<sub>R</sub>: 0.7 V [p-p] 75 Ω</p>
<b>&lt;DVI-D IN&gt; terminal</b>	1 set, DVI-D 24 p, single link, DVI 1.0 compliant, HDCP compatible
<b>&lt;HDMI IN&gt; terminal</b>	1 set, HDMI 19 p, HDCP compatible, Deep Color compatible
<b>&lt;SDI IN&gt; terminal</b> (Only for PT-DZ780)	<p>1 set (BNC)</p> <p><b>SD-SDI signal</b> SMPTE ST 259 compliant</p> <p><b>HD-SDI signal</b> SMPTE ST 292 compliant</p> <p><b>3G-SDI signal</b> SMPTE ST 424 compliant</p>
<b>&lt;SERIAL IN&gt;/&lt;SERIAL OUT&gt; terminal</b>	D-Sub 9 p, 1 set each, RS-232C compliant, for computer control
<b>&lt;REMOTE 1 IN&gt;/&lt;REMOTE 1 OUT&gt; terminal</b>	M3 stereo mini jack, 1 set each, for remote control (wired)/for projector connection control
<b>&lt;REMOTE 2 IN&gt; terminal</b>	1 set, D-Sub 9 p, for contact control
<b>&lt;DIGITAL LINK/LAN&gt; terminal</b>	1 set, RJ-45, for network and DIGITAL LINK connections, PLink compatible, 100Base-TX, Art-Net compatible
<b>&lt;DC OUT 5V&gt; terminal</b>	USB connector (type A) x 1, for power supply only (DC 5 V, maximum 900 mA)

Note

- The model numbers of accessories and optional accessories are subject to change without prior notice.



# Dimensions

Unit: mm

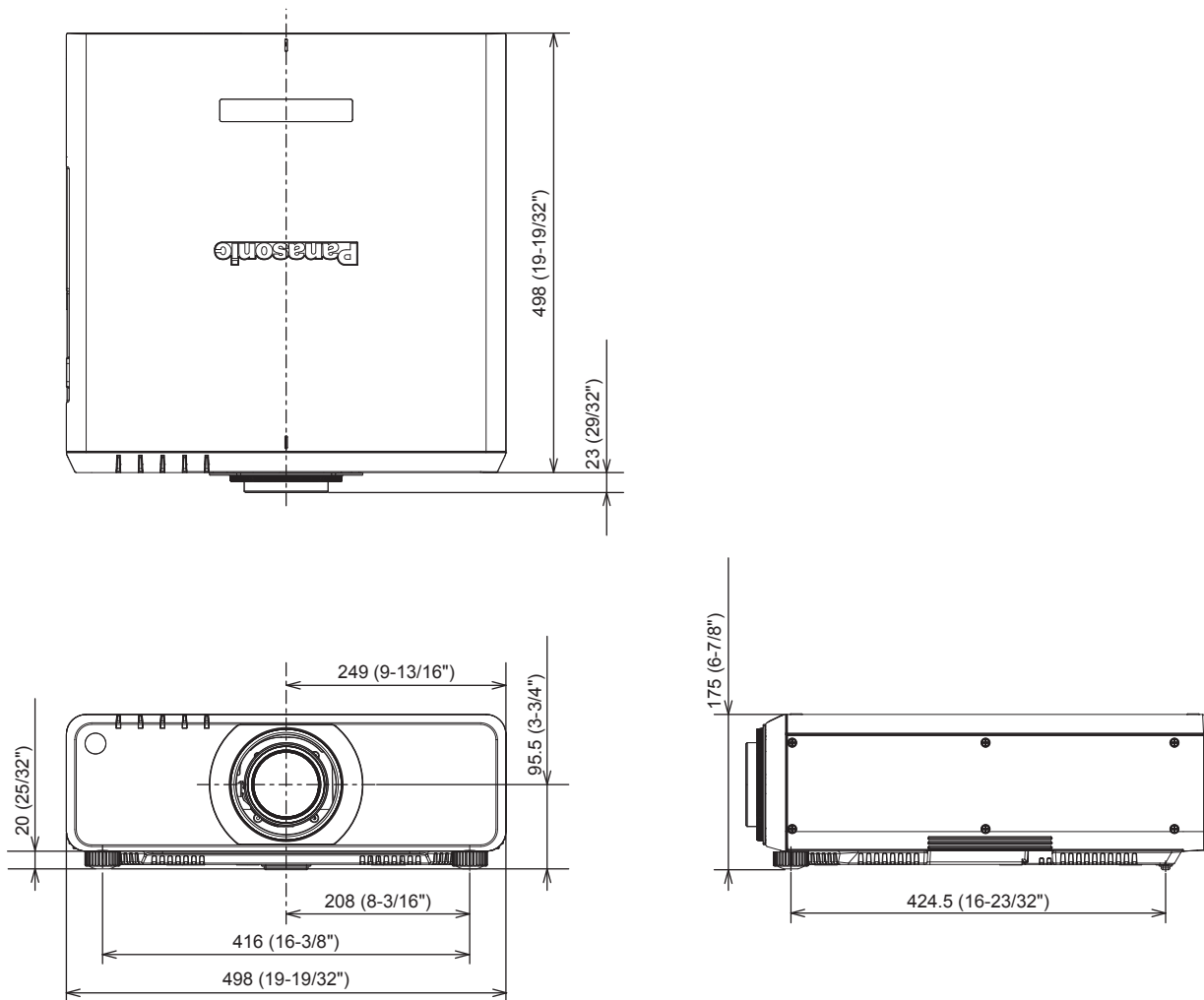

- \* The above dimensions are obtained when the standard zoom lens is attached.
- \* Actual dimensions may differ depending on the product.

## Precautions for attaching the Ceiling Mount Bracket

- When installing the projector to the ceiling, be sure to use the optional Ceiling Mount Bracket (Model No.: ET-PKD120H (for high ceilings), ET-PKD120S (for low ceilings), ET-PKD130H (for High Ceilings, 6-axis Adjustment), ET-PKD130B (Projector Mount Bracket)) specified by Panasonic. The Ceiling Mount Bracket (Model No.: ET-PKD120H (for high ceilings), ET-PKD120S (for low ceilings), ET-PKD130H (for High Ceilings, 6-axis Adjustment)) is used in combination with the Ceiling Mount Bracket (Model No.: ET-PKD130B (Projector Mount Bracket)).
- When installing the projector, attach the drop-prevention set that comes with the ceiling mount bracket to the projector. When the drop-prevention kit (Service Model No.: TTRA0214) is necessary, consult your dealer.
- Ask a qualified technician to do the installation work such as mounting the projector on the ceiling.
- Panasonic takes no responsibility for any damage to the projector resulting from use of a ceiling mount bracket not manufactured by Panasonic or the inappropriate choice of location for installation, even if the warranty period of the projector has not expired.
- Unused products must be removed promptly by a qualified technician.
- Use a torque screwdriver or Allen torque wrench to tighten bolts to their specified tightening torques. Do not use electric screwdrivers or impact screwdrivers.
- Read the Installation Instructions for the ceiling mount bracket for details.
- The model numbers of accessories and optional accessories are subject to change without prior notice.

Bottom view

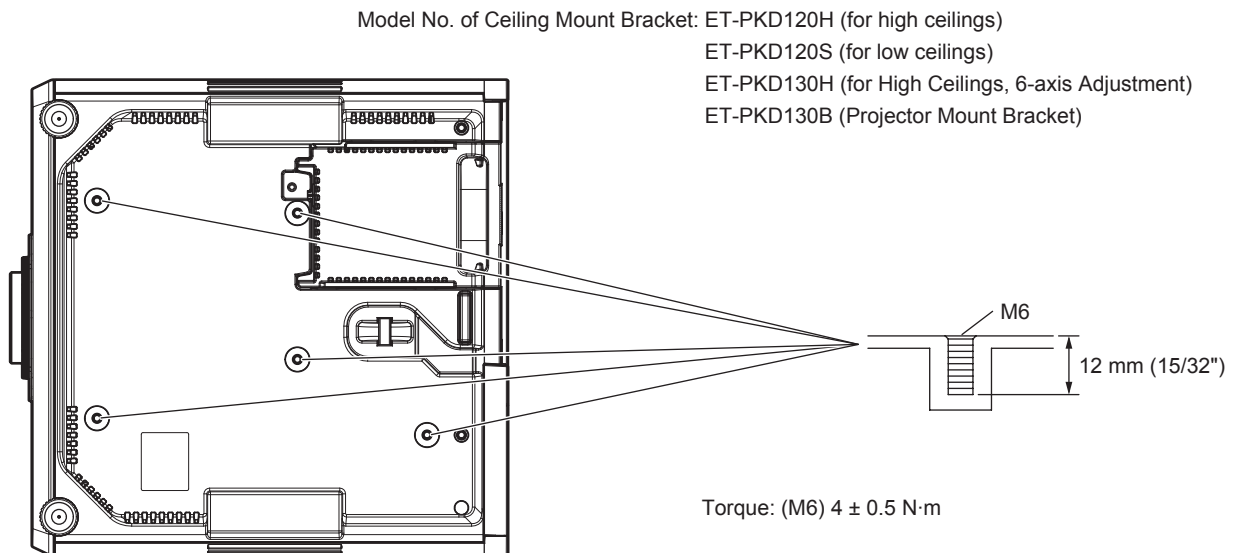

# Index

- A**
- Accessories ..... 22
  - <AC IN> terminal ..... 25, 55
  - Adjusting adjustable feet ..... 46
  - [ADVANCED MENU] ..... 73, 88
  - [AI] ..... 81
  - Air filter ..... 164
  - Art-Net ..... 20, 175
  - [Art-Net SETUP] ..... 141
  - [ASPECT] ..... 83
  - Automatic setup function ..... 68
  - [AUTO SETUP] ..... 96
  - <AUTO SETUP> button
    - Projector body ..... 26, 68
    - Remote control ..... 24, 68
  - [AUTO SIGNAL] ..... 96
- B**
- [BACK COLOR] ..... 106
  - [BACKUP INPUT SETTING] ..... 97
  - [BLANKING] ..... 88
  - [BRIGHTNESS] ..... 76
  - [BRIGHTNESS CONTROL] ..... 114
- C**
- Cautions on use ..... 21
  - Cautions when installing ..... 18
  - Cautions when transporting ..... 18
  - Ceiling Mount Bracket ..... 194
  - [CLAMP POSITION] ..... 89
  - [CLOCK PHASE] ..... 85
  - [CLOSED CAPTION SETTING] ..... 106
  - [COLOR] ..... 77
  - [COLOR CORRECTION] ..... 95
  - [COLOR MATCHING] ..... 94
  - [COLOR TEMPERATURE] ..... 77
  - Connecting the power cord ..... 55
  - Connecting the remote control to the projector
    - with a cable ..... 29
  - Connection ..... 49
  - [CONTRAST] ..... 76
  - [CONTROL DEVICE PASSWORD CHANGE] ..... 136
  - [CONTROL DEVICE SETUP] ..... 135
  - [COOLING CONDITION] ..... 112
  - [Crestron Connected(TM)] ..... 158
  - [CUT OFF] ..... 110
- D**
- [DATE AND TIME] ..... 124
  - <DEFAULT> button
    - Remote control ..... 24, 72
  - Deleting the registered signal ..... 131
  - [DIGITAL CINEMA REALITY] ..... 88
  - DIGITAL LINK ..... 20
  - <DIGITAL LINK> button
    - Projector body ..... 26, 67
    - Remote control ..... 24, 67
  - [DIGITAL LINK IN] ..... 102
  - [DIGITAL LINK MENU] ..... 141
  - [DIGITAL LINK MODE] ..... 138
  - [DIGITAL LINK SETUP] ..... 138
  - [DIGITAL LINK STATUS] ..... 139
  - Dimensions ..... 193
  - Display language ..... 74, 93
  - [DISPLAY OPTION] ..... 74, 94
  - [DISPLAY SETTING] ..... 134
  - Disposal ..... 21
  - <DVI-D> button
    - Projector body ..... 26, 67
    - Remote control ..... 24, 67
  - [DVI-D IN] ..... 99
- E**
- Early Warning Software ..... 21
  - [EDGE BLENDING] ..... 90
  - <ENTER> button
    - Projector body ..... 26
    - Remote control ..... 24
  - Expanding signal lock-in range ..... 132
- F**
- Filter indicator ..... 162
  - <FOCUS> button
    - Remote control ..... 24, 62
  - [FRAME RESPONSE] ..... 91
  - [FREEZE] ..... 108
  - Function button ..... 68
  - <FUNCTION> button
    - Remote control ..... 24, 68
  - [FUNCTION BUTTON] ..... 124
- G**
- [GAMMA] ..... 79
  - [GEOMETRY] ..... 85
- H**
- <HDMI> button
    - Projector body ..... 26, 67
    - Remote control ..... 24, 67
  - [HDMI IN] ..... 101
- I**
- <ID SET> button
    - Remote control ..... 24, 69
  - [INITIALIZE] ..... 126
  - Initial settings ..... 57
  - [INITIAL STARTUP] ..... 120
  - [INPUT RESOLUTION] ..... 89
  - Installation mode ..... 31
- L**
- Lamp indicator ..... 162
  - [LAMP POWER] ..... 113
  - [LAMP RELAY] ..... 113
  - [LAMP SELECT] ..... 112
  - <LENS> button
    - Projector body ..... 26, 62
  - [LENS CALIBRATION] ..... 125
  - List of compatible signals ..... 186
  - [LOAD ALL USER DATA] ..... 126
- M**
- Main menu ..... 72
  - Main power switch ..... 25, 56
  - Maintenance ..... 164
  - <MENU> button
    - Projector body ..... 26, 71
    - Remote control ..... 24, 71
  - Menu item ..... 73
- N**
- Navigating through the menu ..... 71
  - [NETWORK] ..... 75, 138
  - Network connection ..... 142
  - [NETWORK CONTROL] ..... 140
  - [NETWORK SETUP] ..... 139
  - [NETWORK STATUS] ..... 140
  - [NOISE REDUCTION] ..... 80
  - [NO SIGNAL SHUT-OFF] ..... 124
- O**
- <ON SCREEN> button
    - Remote control ..... 24, 66
  - [ON-SCREEN DISPLAY] ..... 104
  - On-screen menu ..... 71
  - Optional accessories ..... 23
- P**
- [PICTURE] ..... 73, 76
  - [PICTURE MODE] ..... 76
  - [P IN P] ..... 75, 128
  - P IN P function ..... 128
  - [POSITION] ..... 73, 83
  - Power cord ..... 55
  - Power indicator ..... 55
  - Power on button
    - Projector body ..... 26
    - Remote control ..... 24
  - Power standby button
    - Projector body ..... 26
    - Remote control ..... 24
  - Precautions for attaching the Ceiling Mount
    - Bracket ..... 194
  - Precautions for use ..... 18
  - Projecting ..... 62
  - [PROJECTION METHOD] ..... 111
  - Projector body ..... 25
  - [PROJECTOR ID] ..... 111
  - [PROJECTOR SETUP] ..... 74, 111
  - Protecting the registered signal ..... 132
- R**
- [RASTER POSITION] ..... 92
  - Read this first! ..... 5
  - Registering new signals ..... 131
  - <REMOTE 1 IN> terminal ..... 29
  - <REMOTE 1 OUT> terminal ..... 29
  - <REMOTE 2 IN> terminal ..... 184
  - [REMOTE2 MODE] ..... 124
  - Remote control ..... 24
  - Remote control operations ..... 66
  - Removing/attaching the projection lens ..... 47
  - Renaming the registered signal ..... 131
  - Replacement ..... 166
  - Replacing the air filter ..... 168
  - Replacing the lamp unit ..... 166
  - Resetting to the factory default ..... 72
  - <RGB1/2> button
    - Remote control ..... 24, 67
  - <RGB1> button
    - Projector body ..... 26, 67
  - <RGB2> button
    - Projector body ..... 26, 67
  - [RGB IN] ..... 98
  - [RS-232C] ..... 121, 180
- S**
- [SAVE ALL USER DATA] ..... 126
  - [SCHEDULE] ..... 119
  - [SCREEN SETTING] ..... 95
  - <SDI> button
    - Projector body ..... 26, 67
    - Remote control ..... 24, 67
  - [SDI IN] ..... 103
  - Security ..... 20
  - [SECURITY] ..... 75, 134
  - [SECURITY PASSWORD] ..... 134
  - [SECURITY PASSWORD CHANGE] ..... 134
  - Selecting the input signal ..... 62
  - <SERIAL IN> terminal ..... 180
  - <SERIAL OUT> terminal ..... 180
  - [SERVICE PASSWORD] ..... 127
  - Setting the remote control ID numbers ..... 69
  - Setting up ..... 31
  - [SHARPNESS] ..... 80
  - [SHIFT] ..... 83
  - <SHIFT> button
    - Remote control ..... 24, 62
  - <SHUTTER> button
    - Projector body ..... 26, 66
    - Remote control ..... 24, 66
  - [SHUTTER SETTING] ..... 108
  - [SIGNAL LIST] ..... 75, 131
  - Specifications ..... 189
  - sRGB-compliant video ..... 81
  - [STANDBY MODE] ..... 118
  - [STARTUP INPUT SELECT] ..... 120
  - [STARTUP LOGO] ..... 107
  - [STATUS] ..... 122
  - <STATUS> button
    - Remote control ..... 24, 67
  - Sub memory ..... 133
  - Switching off the projector ..... 61
  - Switching on the projector ..... 56
  - Switching the input signal ..... 67
  - [SYSTEM DAYLIGHT VIEW] ..... 80
  - [SYSTEM SELECTOR] ..... 81
- T**
- Temperature indicator ..... 163
  - [TEST PATTERN] ..... 75, 130
  - <TEST PATTERN> button
    - Remote control ..... 24, 68
  - [TEXT CHANGE] ..... 135
  - [TINT] ..... 77
  - Troubleshooting ..... 169
  - Two-window ..... 185
- U**
- [UNIFORMITY] ..... 107
  - Upgrade Kit ..... 186
- V**
- <VIDEO> button
    - Remote control ..... 24, 67
- W**
- [WAVEFORM MONITOR] ..... 108
  - [WHITE GAIN] ..... 79
- Z**
- [ZOOM] ..... 84
  - <ZOOM> button
    - Remote control ..... 24, 62

## Information for Users on Collection and Disposal of Old Equipment and used Batteries



These symbols on the products, packaging, and/or accompanying documents mean that used electrical and electronic products and batteries should not be mixed with general household waste. For proper treatment, recovery and recycling of old products and used batteries, please take them to applicable collection points, in accordance with your national legislation and the Directives 2002/96/EC and 2006/66/EC.

By disposing of these products and batteries correctly, you will help to save valuable resources and prevent any potential negative effects on human health and the environment which could otherwise arise from inappropriate waste handling.



For more information about collection and recycling of old products and batteries, please contact your local municipality, your waste disposal service or the point of sale where you purchased the items.

Penalties may be applicable for incorrect disposal of this waste, in accordance with national legislation.



### For business users in the European Union

If you wish to discard electrical and electronic equipment, please contact your dealer or supplier for further information.

Cd

### Information on Disposal in other Countries outside the European Union

These symbols are only valid in the European Union. If you wish to discard these items, please contact your local authorities or dealer and ask for the correct method of disposal.

### Note for the battery symbol (bottom two symbol examples):

This symbol might be used in combination with a chemical symbol. In this case it complies with the requirement set by the Directive for the chemical involved.

## Product Information (for Turkey only)



AEEE Yönetmeliğine Uygundur.

Eski Ekipman ve Bataryaların İşlenmesi.

Sadece geri dönüşüm sistemleri olan Avrupa Birliği ve ülkeleri için geçerlidir.

Ürünler, ambalaj ve/veya ekli belgeler üzerindeki bu semboller kullanılmış elektrik ve elektronik ürünlerin ve pillerin genel ev atığı ile karıştırılmaması gerektiğini ifade eder.

Eski ürünlerin ve pillerin toplanması ve geri kazanılması için bu atıkları lütfen yasayla belirlenmiş olan uygun toplama merkezlerine teslim ediniz.

Bu atıkların doğru işlenmesiyle, değerli kaynakların korunmasına ve insan sağlığı ve çevreye olası negatif etkilerinin engellenmesine yardımcı olabilirsiniz.

Atıkların toplanması ve geri dönüşümü için detaylı bilgi için lütfen bağlı olduğunuz yerel yönetimlerle iletişime geçiniz.

Atıkların atılmasıyla ilgili yanlış uygulamalar yasayla belirlenmiş olan cezalara sebebiyet verebilir.

# Panasonic Corporation

Web Site : <http://panasonic.net/avc/projector/>

© Panasonic Corporation 2015

## Panasonic System Communications Company of North America

5th Floor, Two Riverfront Plaza, Newark, NJ 07102-5490

TEL: (877) 803 - 8492

## Panasonic Canada Inc.

5770 Ambler Drive, Mississauga, Ontario L4W 2T3

TEL: (905) 624 - 5010