

# Panasonic

BUSINESS

**AW-HE40SW/SK** [SDI Model]  
**AW-HE40HW/HK** [HDMI Model]  
HD Integrated PTZ Camera

For indoor use



AW-HE40SW/AW-HE40HW



Features 30x optical zoom lens  
and support for PoE+\*  
for outstanding operability  
and installation flexibility

AW-HE40SK/AW-HE40HK



\*Abbreviation of Power over Ethernet Plus.



# Full HD camera with integrated pan-tilt for lectures, meetings and a wide variety of applications.

The AW-HE40 series of integrated full HD cameras performs in a wide variety of onsite shooting applications that require high-quality video, such as conferences, lecture capture and other events, thanks to its high-performance zoom, wide angle of view and outstanding color reproducibility. In addition to IP video transmission, support for PoE\*<sup>1</sup> enables power to be supplied via a LAN cable\*<sup>2</sup>. The result is installation flexibility. It also supports HD-IP video output, output of video and audio via USB, and SD card recording.

## Developed 1/2.3-type MOS Sensor

Equipped with a developed 1/2.3-type MOS sensor and DSP (Digital Signal Processor) for high sensitivity and high resolution.

## High Performance Optical 30x Zoom Lens/ Super Resolution 40x Zoom

In addition to a 30x optical zoom, the AW-HE40 series can zoom up to 40x while maintaining high resolution thanks to Super Resolution technology. It also features a 16x digital zoom\*<sup>3</sup> and a 1.4x digital extender, which enables the AW-HE40 series to shoot in large conference halls and classrooms.

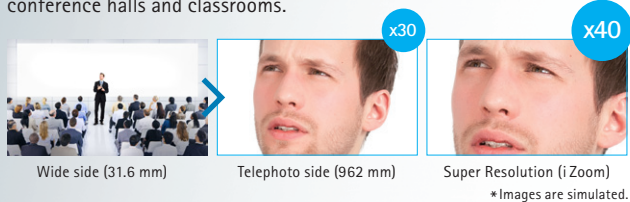

## Night Mode (supports automatic switching)

Switching to Night Mode makes shooting possible even in low light conditions in which shooting is normally difficult, such as when observing wildlife\*<sup>4</sup>. The AW-HE40 series can also be set to switch to the mode automatically depending on surrounding light levels.



## Equipped with High Dynamic Range (HDR) Mode

In addition to conventional Dynamic Range Stretch (DRS) and Digital Noise Reduction (DNR), the AW-HE40 series are newly equipped with High Dynamic Range (HDR) mode. When shooting and synthesizing two images with differing exposure times, the AW-HE40 series can create video with high visibility that corrects for halation and black defects even under backlit conditions.

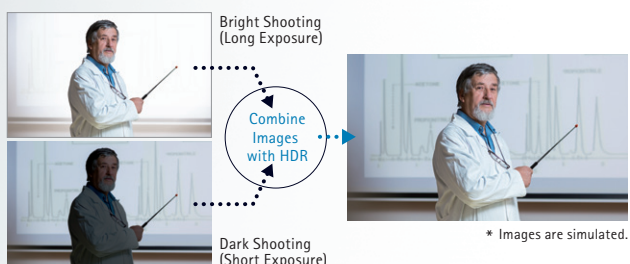

## Outputs Still Image During Preset Movements; Supports One-Camera Operations

The new Freeze During Preset function enables to freeze the video during preset playback. The immediately preceding still image is output during preset movements so that the swiveling movement is not displayed, making operations possible with one camera.

### With Freeze During Preset function OFF and ON



## Either SDI Model or HDMI Model Can Be Selected To Match Usage Needs

Supports 1080/59.94p (HDMI model only), 29.97p\*<sup>5</sup>, 59.94i, 29.97PsF, 1080/50p (HDMI model only), 25p\*<sup>5</sup>, 50i, 25PsF, 720/59.94p, and 50p video formats. Flexible operation in line with the application is made possible by a lineup that includes an SDI output model (AW-HE40SW/SK), optimal for video content production, and an HDMI output model (AW-HE40HW/HK), optimal for video streaming, both of which come in two body colors (white and black) that can be selected depending on the usage environment.

## Video/Audio Output with USB

USB Video Class and USB Audio Class are supported. This enables video and audio output via USB so the cameras can be used as high-image-quality Web cameras for Web conferencing, distance learning, and other applications utilizing communication software.

## Audio Input Function

The AW-HE40 series also supports audio input, embedding and encoding. Audio output to IP is also supported. The ALC (Audio Automatic Level Control) in the original AW-HE40 series can be switched ON/OFF and an equalizer function can be used. By reducing low-frequency sound from air conditioners, projectors, and other devices, it is possible to emphasize and increase the clarity of the spoken words.

\*1: Abbreviation of Power over Ethernet Plus. \*2: The software for the AW-HE40 series may need to be updated depending on the existing software version. For details, see the Panasonic website (<https://pro-av.panasonic.net/>). \*3: Picture quality is lower with the digital zoom. \*4: Video output is monochrome. \*5: Native output.

## microSD Card Recording Function

MicroSD card recording is supported. Camera video and audio can be recorded in MP4 format on microSD card (sold separately) inserted into the unit. In addition, using an IP network, it is possible to externally control recording start/stop and download the recorded files.



## Full HD Video Output Via IP Transmission

In addition to HD-SDI and HDMI output, production quality full HD video output via IP transmission is supported. The camera delivers up to four channels of IP streaming video (H.264), with a maximum quality level of 1080/60p at 24 Mbps\*1. Simultaneous transmission to as many as 14 devices is also supported\*2. Flexible system setup is possible to meet various application needs.



## List of Supported Multi-Streaming Outputs (When IP output priority is selected)\*

Settings	H.264			JPEG
	CH1	CH2*3	CH3*3/CH4*4	CH1/CH2/CH3
Resolution	1920x1080 1280x720*3 640x360*5	1280x720 640x360 320x180	1280x720 640x360 320x180	1920x1080*4 1280x720*3 640x360 320x180*3
Frame rate	59.94 Hz 60 fps/30 fps/15 fps/5 fps 50 Hz 50 fps/25 fps/12.5 fps/5 fps	30 fps/15 fps/5 fps 25 fps/12.5 fps/5 fps	30 fps/15 fps/5 fps 25 fps/12.5 fps/5 fps	30 fps/15 fps/5 fps 25 fps/12.5 fps/5 fps
Bit rate	Up to 24 Mbps			
Voice transmission	Yes (AAC48 kHz)			
PoE+	Yes			

\* Depending on the output mode, certain restrictions apply.

## NDI|HX Compatibility for Excellent Video Streaming Quality

The AW-HE40 series can be upgraded to an NDI|HX compatible model if purchasing a license from the NewTek website ([https://pro-av.panasonic.net/en/ndihx\\_support/index.html](https://pro-av.panasonic.net/en/ndihx_support/index.html)). Highly efficient NDI|HX compatibility enables excellent broadcast streaming by encoding and transmitting high-quality video in real time. This technology eliminates the need for IP decoders, allowing input to be sent directly to the switcher.

\* Contact your local Panasonic vendor for further information.

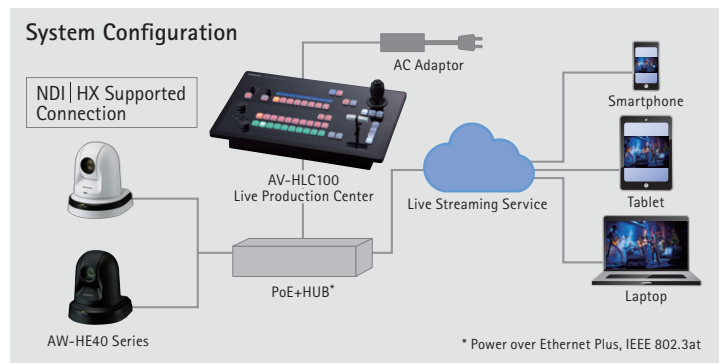

## Supporting PoE+\*6 for Lower Installation Costs

By connecting network devices that support the IEEE802.3at PoE+ standard, power can be supplied via LAN cable. Since it is not necessary to install a power supply or even a local AC outlet, installation costs can be significantly reduced.

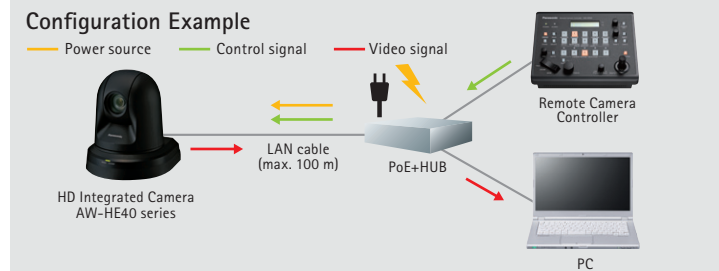

## IP Control with Image Monitoring Using PC, Mac and Mobile Terminals

Using an IP browser, the camera can be controlled from a remote location, and IP video monitoring and remote camera control can be performed from a PC, Mac or mobile terminal such as an iPhone, iPad or Android device, enabling easy operations. IP video\*7 can be transmitted to up to 14 terminals\*1.

\*For the latest information on supported OS/browsers, please refer to the "service and support" section on the Panasonic website (<https://pro-av.panasonic.net/>).

### Camera Control Screen (PC)



Live Screen

### Mobile Terminal Screen



## Flexible IP Control Architecture Simplifies System Design and Operation\*8

Up to 100 x AW-HE40 series cameras can be controlled via IP from a single AW-RP120G/RP50 or PC. An AW-HE40 series can also be simultaneously controlled by up to five AW-RP120G/RP50 controllers via IP.

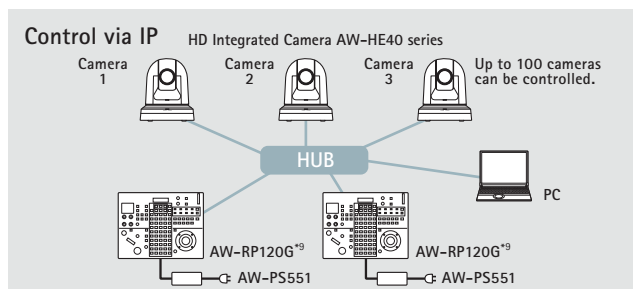

\*1: 1920 x 1080 60 fps output is 1ch display only. For 2ch or more, display is max. 30 fps. Also, JPEG output is up to 3ch. \*2: Depends on your network environment. \*3: Settable when HDR is "Off". \*4: Settable when HDR is set to "Off" and the frame rate is other than 60fps (or 50fps). \*5: Not settable when HDR is "Off". \*6: Abbreviation of Power over Ethernet Plus. \*7: Supports only SD video output. \*8: Controller upgrade required. For details, please refer to the "service and support" section on the Panasonic website (<https://pro-av.panasonic.net/>). \*9: AC adaptor AW-PS551 (sold separately) is required for AW-RP120G.

# Exceptional Pan-tilt Performance for Smooth Shooting Over a Wide Area\*1

The pan range of  $\pm 175^\circ$  and the tilt range of  $-30^\circ$  to  $+90^\circ$  cover a wide shooting area\*1. Pan and tilt operate at a maximum speed of  $90^\circ/\text{second}$  and respond quickly to remote control operation. They operate quietly at a sound level of NC35 or lower.

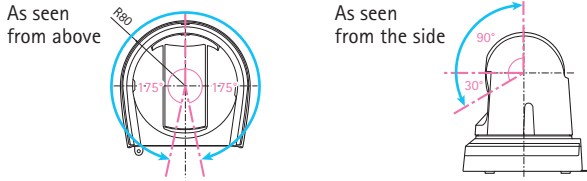

\*1. Depending on the position of the pan and tilt, the unit itself may be reflected in the image.

## Other Functions

- Preset memory up to 100 positions.
- Functions such as freeze during preset, digital extender zoom and color temperature settings can be assigned to the user buttons on Panasonic controllers.
- Equipped with RS422 remote terminal; up to five units can be controlled via serial control from a controller.
- Equipped with RS232C remote terminal (standard serial communication support). Up to seven units can be controlled via daisy chain connection.
- Up to four units can be operated with a wireless remote controller (AW-RM50G sold separately).
- Easy installation thanks to use of turn-lock mechanism.

## System Configuration Example

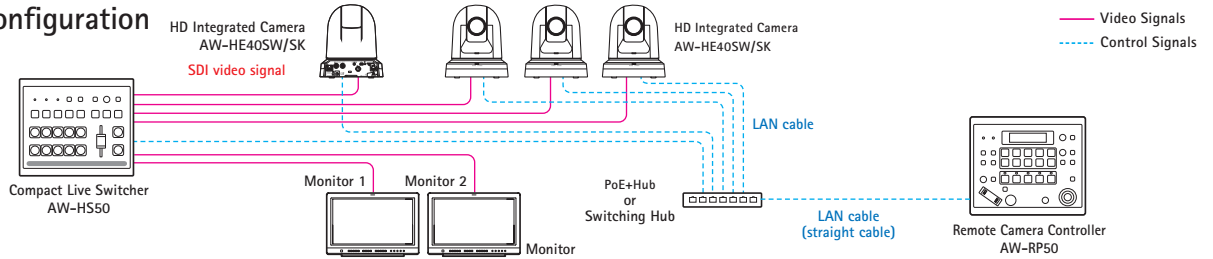

\* The AC adaptor provided with the unit is not shown in the above figure. \* SDI output supported only by AW-HE40SW/SK.  
\* The camera unit automatically recognizes straight cables and cross cables connected to the LAN terminal.

## Optional Software

### Supporting Lecture Capture with Auto Tracking function

Auto Tracking Software Key  
**AW-SF100/AW-SF200**  
2 Additional Licenses AW-SF202  
3 Additional Licenses AW-SF203

A 30-day Free Trial is Available



AW-SF200 Main View

### (Main Features)

- Motion detection and face detection technologies using video streaming from camera achieve smooth auto tracking regardless of where the person is facing.
- GUI designed for intuitive operation.
- Operation with IP connection enables installation/control of cameras in remote classroom.
- AW-SF100 allows a single PTZ camera to be controlled on either a stand-alone or web application version.
- The stand-alone version is easy to set up by installing software on a PC\*2 and connecting HD integrated cameras; Installation of sensors and other devices are not necessary.
- The web application version enables camera control from a tablet, smartphone, desktop PC, etc.
- AW-SF200 enables simultaneous auto tracking and centralized control of multiple cameras.\*3

\*2: When the web application version is used, Auto Tracking Software needs to be installed on an HTTP server.

\*3: Up to four cameras per server can be controlled simultaneously.

● The face recognition function is based upon the face recognition software developed by PUX Corporation. \* Depending on the shooting environment, the system may not be able to detect or track the target correctly. Please use this software in an environment where the adjustment work can be performed by the operator to deal with errors in detection and auto tracking. \* There is a 30-day free trial available for the Auto Tracking Software. Please read carefully the precautions for this software and check if it works correctly in your operating environment before you purchase "Auto Tracking Software Activation Key". For further information, please see "Software Download" on the Panasonic website <<https://pro-av.panasonic.net/>>.

### PTZ Control Center

Free Software

- Intuitive GUI with the capability to control multiple cameras.
- Image quality adjustment and pan-tilt-zoom control on a GUI.
- Easy to recall presets by clicking preset buttons with thumbnails.



Main View

### PTZ Virtual USB Driver

Free Software

- High quality video perfect for web conferencing, utilizing a PTZ camera on the network as a USB camera.
- Automatic detection of connected cameras, and network settings supported.

\* For further information on the optional software, please see "Software Download" on the Panasonic website <<https://pro-av.panasonic.net/>>.

## Easy Wireless Control Using an iPad\*4 with a Control Assist Camera\*5



Control Assist Camera  
**AW-HEA10W**

### Range of lens movement

This is adjustable  $30^\circ$  vertically and  $45^\circ$  horizontally.

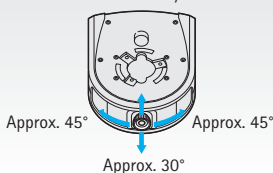

Control Assist Camera  
**AW-HEA10K**

### Usage example

4K/HD Integrated Camera video

Control Assist Camera video



- Used in combination with a 4K/HD Integrated Camera\*5.
- $95^\circ$  wide-angle view from the Control Assist Camera is displayed on an iPad.
- Tapping the desired area of the wide-angle view displayed on the iPad\*4 turns the field of view of the 4K/HD Integrated Camera\*5 to the tapped position.

\*4: An iPad (sold separately) and a wireless AP (sold separately) are required. Please install the iPad application "PTZ Cntrl" (free). For details, please visit Panasonic AW-HEA10W/K website ([https://pro-av.panasonic.net/en/sales\\_o/camera/aw-hea10/](https://pro-av.panasonic.net/en/sales_o/camera/aw-hea10/)).

\*5: AW-HE130/HN130 series, AW-UE70/UN70 series, AW-HE40/HN40 series, and AW-HE38/HN38 series only.

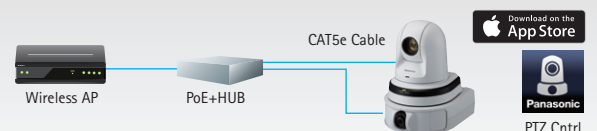

The iPad application "PTZ Cntrl" can be downloaded for free from the App Store. This application enables control of pan, tilt, zoom, focus, iris and gain. For details, please visit the Panasonic AW-HEA10W/K product site ([https://pro-av.panasonic.net/en/sales\\_o/camera/aw-hea10/](https://pro-av.panasonic.net/en/sales_o/camera/aw-hea10/)).

# Specifications

As of April, 2018

GENERAL	Power requirements	DC 12 V (Supplied AC adaptor) DC 42 V to 57 V (PoE+ power supply)		Chroma amount variability	±3 step		
	Current consumption	1.2 A (Supplied AC adaptor) 0.4 A (PoE+ power supply)		Scene file	Full Auto, Manual1, Manual2, Manual3		
	Ambient operating temperature	0 °C to 40 °C (32 °F to 104 °F)		Output format	HD	1080:59.94p/50p*4	
	Storage temperature	-20 °C to 50 °C (-4 °F to 122 °F)				1080:59.94i/50i	
	Allowable humidity ranges	20 % to 90 % (no condensation)				1080:29.97p/25p	
	Mass	Approx. 1.5 kg (3.30 lb)				1080:29.97PsF/25PsF	
	Dimensions (W x H x D)	160 mm x 186 mm x 166 mm (6-5/16 inches x 7-41/128 inches x 6-17/32 inches) (excluding protrusions, direct ceiling mount bracket)		Synchronization system	Internal synchronization		
	Finish	[AW-HE40HWPJ9], [AW-HE40SWPJ9], [AW-HE40HWEJ9], [AW-HE40SWEJ9] Pearl white [AW-HE40HKPJ9], [AW-HE40SKPJ9], [AW-HE40HKEJ9], [AW-HE40SKEJ9] Metallic black		[USB connection]	* This may vary depending on the operating environment.		
Controller supported*1	AW-RP120G, AW-RP50, AK-HRP200G, AK-HRP1000G, AK-HRP1005GJ		Video output	USB Video Class Ver1.0			
INPUT	Power	DC 12 V IN, PoE+ (IEEE802.3at standard)		Video compression format	Motion JPEG		
		Stereo mini-jack (ø3.5 mm) Input impedance: Approx. 2 kΩ (unbalanced) [Mic input] Supported microphones: Stereo mic (plug-in power, on/off switching via menu) Supplied voltage: 2.5 V ± 0.5 V Mic input level: -60 dBV ± 3 dBV [Line input] Input level: -10 dBV ± 3 dBV		Resolution	1920 x 1080, 1280 x 720, 640 x 360		
		Stereo mini-jack (ø3.5 mm) Input impedance: Approx. 2 kΩ (unbalanced) [Mic input] Supported microphones: Stereo mic (plug-in power, on/off switching via menu) Supplied voltage: 2.5 V ± 0.5 V Mic input level: -60 dBV ± 3 dBV [Line input] Input level: -10 dBV ± 3 dBV		Frame rate	max 30 fps (System frequency 59.94 Hz) max 25 fps (System frequency 50 Hz)		
OUTPUT	Video output	HDMI	[AW-HE40HW/HK] HDMI connector * HDCP is not supported. * VIERA Link is not supported.	Audio output	USB Audio Class Ver1.0		
		HD SDI OUT	[AW-HE40SW/SK] Compliant with the SMPTE292M standards/75 Ω(BNC x 1)	Audio compression format	Linear PCM, 48 kHz, 16-bit, 2 channels		
INPUT/ OUTPUT	Input/ Output connector	LAN	LAN connector for IP control (RJ-45) Equipped with straight/crossover cable auto detection function	Supported models	Devices standardly equipped with a USB 2.0 compatible port		
		RS-232C	Mini DIN 8-pin (IN) Mini DIN 8-pin (OUT)	[Pan-tilt head unit]			
		RS-422	CONTROL IN RS422A (RJ-45)	Installation method	Stand-alone (Desktop) or suspended (Hanging)*5		
		USB	Mini-B port	Pan/tilt operation speed	Maximum speed during preset: 300°/s Maximum speed during manual: 90°/s		
		SD card	microSD card slot	Panning range	±175°		
FUNCTIONS AND PERFORMANCE	[Camera unit]			Quietness	During preset: NC40 or less During manual: NC35 or less		
	Imaging sensors	1/2.3-type MOS		[Camera/pan-tilt head control]			
	Lens	Motorized 30x zoom, F1.6 to F4.7 [f=4.3 mm (11/64 inches) to 129 mm(5-5/64 inches); 35 mm (1-3/8 inches) equivalent: 31.6 mm (1-31/128 inches) to 962.0 mm (37-7/8 inches)]		IP connecting cable	When connecting through a hub: LAN cable*7 (category 5 or above),max. 100 m (328 ft) When using a PoE+ hub: LAN cable*7 (category 5e or above),max. 100 m (328 ft) When a hub is not used: LAN cable*7 (category 5 or above),max. 100 m (328 ft)		
	Focus	Switching between auto and manual			AW protocol connecting cable LAN cable*7 (category 5 or above,straight cable), max. 1000 m (3280 ft)		
	Focus distance	Entire zooming range:1.2 m (3.94 ft) Wide end: 10 cm (0.33 ft)			Standard protocol connecting cable Mini DIN 8-pin cable, male		
	Color separation optical system	On-chip color filter system		[SD card recording]			
	Minimum illumination	59.94 Hz	0.7 lx (50 IRE, F1.6, 48 dB,1/60 without accumulation) 0.35 lx (50 IRE, F1.6, 48 dB,1/30 with accumulation[Frame Mix 6 dB])		SD card type	micro SDHC (4 GB to 32 GB), micro SDXC (64 GB to 128 GB), Speed class 10 or higher	
		50 Hz	0.7 lx (50 IRE, F1.6, 48 dB,1/50 without accumulation) 0.35 lx (50 IRE, F1.6, 48 dB,1/25 with accumulation[Frame Mix 6 dB])		System frequency	59.94 Hz/50 Hz	
	Horizontal resolution	1000 TV lines Typ (Center area)		Video compression format	MPEG-4 AVC/H.264 High Profile		
	Gain selection*2	Auto, 0 dB to 48 dB (3 dB step)		Audio compression format	AAC-LC (48 kHz, 16 bit, 2 ch, 128 kbps)		
	Frame mix*3	Auto, Off, 6 dB, 12 dB, 18 dB, 24 dB		SD card recording	MPEG-4 AVC file standard compliant (.MP4)		
	Electronic shutter speed	During	1/30 to 1/2000 [59.94 Hz] Full Auto 1/25 to 1/2000 [50 Hz]		Recording format	1920 x 1080/59.94p, 1920 x 1080/50p, 1920 x 1080/29.97p, 1920 x 1080/25p, 1280 x 720/59.94p, 1280 x 720/50p, 1280 x 720/29.97p, 1280 x 720/25p	
		During Auto	1/60 to 1/2000 [59.94 Hz] 1/50 to 1/2000 [50 Hz]		[Network]		
		Manual	1/100, 1/250, 1/500, 1/1000, 1/2000, 1/4000, 1/10000 [59.94 Hz] 1/120, 1/250, 1/500, 1/1000, 1/2000, 1/4000, 1/10000 [50 Hz]		Resolution	JPEG VGA (640 x 360), QVGA (320 x 180) max.30 fps 1920 x 1080, 1280 x 720, 640 x 360, 320 x 180 max.30 fps H.264 1920 x 1080, 1280 x 720, 640 x 360, 320 x 180 max.60 fps	
	Synchro scan	59.94 Hz : 59.94 Hz to 660.09 Hz 50 Hz : 50.00 Hz to 570.12 Hz		Supported protocol	IPv4 TCP/IP, UDP/IP, HTTP, HTTPS, RTSP, RTP, RTCP, FTP, DHCP, DNS, NTP, IGMP, UPnP, ICMP, ARP, RTSPoverTCP, RTSPoverHTTP, SSL(TLS), MultiCast/UniCast IPv6 TCP/IP, UDP/IP, HTTP, HTTPS, RTSP, RTP, RTCP, FTP, DHCPv6, DNS, NTP, ICMPv6(MLD), RTSPoverTCP, RTSPoverHTTP, SSL(TLS), MultiCast/UniCast		
Gamma	Off, Normal (Low, Mid, High), Cinema		i-OS, Android support	JPEG image display			
White balance	AWB A, AWB B, ATW, 3200K,5600K, VAR (2400K to 9900K)		ACCESSORIES				
			Mount bracket for installation surface (Hanging*8 / Desktop): 1 Drop-prevention wire (already attached to the unit): 1 Bracket mounting screws (bind-head) M4 x 10 mm: 4 Main unit mounting screw (with flat washer, spring washer) M3 x 6 mm: 1 Power cable (1.5 m [4.92 ft]): 1 AC adaptor: 1 CD-ROM: 1				

\*1: It may be necessary to upgrade the version of the controller so that the controller will support the unit. \*2: During Auto, 6 dB to 48 dB (6 dB step) are available for AGC Max Gain setting.  
\*3: During Auto, 0 dB, 6 dB, 12 dB, 18 dB and 24 dB are available for Auto F.Mix Max Gain setting. \*4: AW-HE40HW/HK only \*5: To ensure safety, the unit must be secured using the mount bracket supplied.  
\*6: Depending on the pan or tilt position, the camera may be reflected in the image. \*7: Use of an STP (shielded twisted pair) cable is recommended.  
\*8: To ensure more safety, AW-HE40 series can be secured by using the direct ceiling mount bracket (WV-Q105A).

## Required personal computer environment

As of April, 2018

CPU	When using 1080/60p [59.94 Hz] and 1080/50p [50 Hz] Intel® Core™ i7 3.4 GHz or higher recommended Other than above Intel® Core™ i7 3.4 GHz or higher recommended	
Memory	For Windows	1 GB or higher (2 GB or higher for Microsoft® Windows® 8.1, Microsoft® Windows® 8, Microsoft® Windows® 7 64-bit edition)
	For Mac	2 GB or more
Network function	10BASE-T or 100BASE-TX port x 1	
Image display function	Resolution: 1024 x 768 pixels or more Color generation: True Color 24-bit or more	
Supported operating system and Web browser	Windows	Microsoft® Windows® 8.1 Pro 64-bit/32-bit*9 Windows® Internet Explorer® 11.0*9 Microsoft® Windows® 8 Pro 64-bit/32-bit*9 Windows® Internet Explorer® 10.0*9 Microsoft® Windows® 7 Professional SP1 64-bit/32-bit*10 Windows® Internet Explorer® 8.0 / 9.0 / 10.0 / 11.0*11
	Mac	OS X 10.8 Safari 6.2 / OS X 10.9 Safari 7.1 / OS X 10.10 Safari 8.0
	iPhone / iPad / iPod touch	iOS 8.3 Standard browser
	Android	Android OS 4.4 Standard browser
Other	CD-ROM drive (for using the Operating Instructions and various software) Adobe® Reader® (for viewing the Operating Instructions on the CD-ROM)	

\*9: Use the desktop version of Internet Explorer. (Internet Explorer for Windows UI is not supported.) \*10: Windows® XP compatibility mode is not supported.  
\*11: The 64-bit version of Internet Explorer® is not supported.

For the latest information on supported OS/browser, please refer to the "service and support" on the Panasonic website (<https://pro-av.panasonic.net>).

- Microsoft®, Windows®, Windows® 7, Windows® 8, Windows® 8.1 and Internet Explorer® are either registered trademarks or trademarks of Microsoft Corporation in the United States and other countries.
- Apple, Mac, OS X, iPhone, iPod Touch, iPad, and Safari are registered trademarks of Apple Inc., in the United States and other countries.
- Android™ is a trademark of Google Inc.

## Rear View

AW-HE40SW/SK



AW-HE40HW/HK



## Bottom View

Unit: mm(inches)

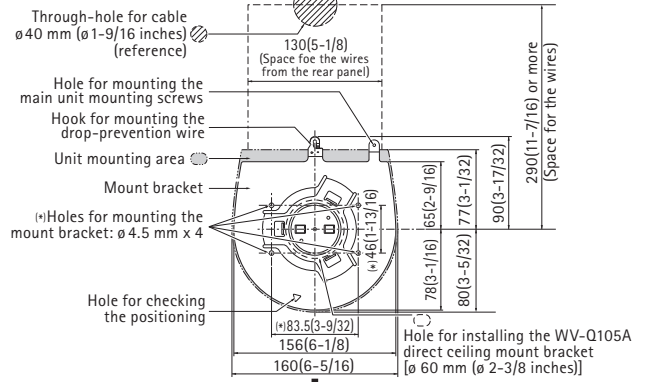

The front panel of the unit on this side.

## System Camera Options

As of April, 2018

<p>Live Production Center <b>AV-HLC100</b></p> 	<p>Control Assist Camera <b>AW-HEA10W/K</b></p> 	<p>Remote Camera Controller <b>AW-RP50</b></p> 
<p>Wireless Remote Control <b>AW-RM50G</b> <small>("AA", "R6" or "LR6" battery x 2 are not included.)</small></p> 	<p>Remote Camera Controller <b>AW-RP120G</b> <small>(AC adaptor (DC12 V) is required separately.)</small></p> 	<p>Remote Operation Panel <b>AK-HRP200G</b> <small>(AC adaptor (DC12 V) is required separately.)</small></p> 
	<p>Compact Live Switcher <b>AW-HS50</b></p> 	<p>Direct Ceiling Mount Bracket <b>WV-Q105A</b></p> 

For more information, please visit Panasonic web site



<https://pro-av.panasonic.net/>

\*Specifications are subject to change without notice.

# Panasonic®

Panasonic Corporation  
Connected Solutions Company

2-15 Matsuba-cho, Kadoma, Osaka 571-8503 Japan  
<https://pro-av.panasonic.net/>

### [Countries and Regions]

Argentina +54 11 4122 7200  
Australia +61 (0) 2 9491 7400  
Brazil +55 11 3889 4035  
Canada +1 905 624 5010  
China +86 10 6515 8828  
Hong Kong +852 2313 0888  
Czech Republic +421 (0) 903 447 757  
Denmark +45 43 20 08 57  
Egypt +20 2 23938151  
Finland, Latvia, Lithuania, Estonia +358 (9) 521 52 53  
France +33 (0) 1 47 91 64 00  
Germany, Austria, Switzerland +49 (0) 6103 313887  
Greece +30 210 96 92 300  
Hungary +36 (1) 382 60 60  
India +91 1860 425 1860  
Indonesia +65 6277 7284  
Iran (Vida) +98 21 2271463  
(Panasonic Office) +98 2188791102  
Italy +39 02 6788 367  
Jordan +962 6 5859801  
Kazakhstan +7 727 330 8808  
Korea +82 2 2106 6641

Kuwait +96 522431385  
Lebanon +96 11665557  
Malaysia +60 3 7809 7888  
Mexico +52 55 5488 1000  
Mongolia +976 70115577  
Netherlands, Belgium +31 73 640 2729  
New Zealand +64 9 272 0100  
Norway +47 67 91 78 00  
Pakistan +92 21 111 567 111  
Palestine +972 2 2988750  
Panama +507 229 2955  
Philippines +65 6277 7284  
Poland +48 (22) 338 1100  
Portugal +351 21 425 77 04  
Romania, Albania, Bulgaria, Macedonia +40 (0) 729 164 387  
Russia & CIS +7 495 9804206  
Saudi Arabia +966 (1) 4790499  
Singapore +65 6277 7284  
Slovak Republic, Croatia, Serbia, Bosnia, Montenegro, Slovenia +421 (0) 903 447 757  
South Africa +27 11 3131622  
Spain +34 (93) 425 93 00

Sweden +46 (8) 680 26 41  
Taiwan +886 2 2227 6214  
Thailand +662 731 8888  
Turkey +90 216 578 3700  
U.A.E. (for All Middle East) +971 4 8862142  
Ukraine +380 44 4903437  
U.K. +44(0)1344 70 69 13  
U.S.A. +1 877 803 8492  
Vietnam +65 6277 7284



Factories of AVC Networks Company have received ISO14001:2004-the Environmental Management System certification. (Except for 3rd party's peripherals.)