

Panasonic®

Operating Instructions Functional Manual

UHD LCD Display For business use

Model No. **TH-86CQ1W** 86-inch model
TH-75CQ1W 75-inch model
TH-65CQ1W 65-inch model
TH-55CQ1W 55-inch model
TH-50CQ1W 50-inch model
TH-43CQ1W 43-inch model

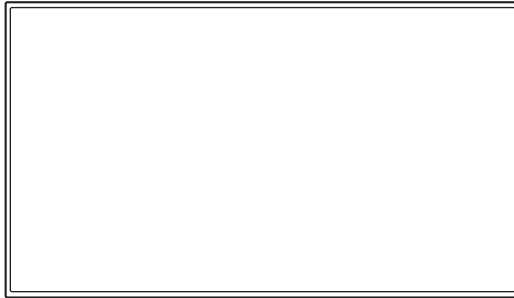

* This manual is common to all the models regardless of suffixes of the model number.

English

Please read these instructions before operating your set and retain them for future reference.

4K
PROFESSIONAL

*Actual resolution: 3840 × 2160p

HDMI™

DOLBY AUDIO™

Manufactured under license from Dolby Laboratories.
Dolby, Dolby Audio and the double-D symbol are trademarks of Dolby Laboratories.



Dear Panasonic Customer

Welcome to the Panasonic family of customers. We hope that you will have many years of enjoyment from your new UHD LCD Display.

To obtain maximum benefit from your set, please read these Instructions before making any adjustments, and retain them for future reference.

Retain your purchase receipt also, and note down the model number and serial number of your set in the space provided on the rear cover of these instructions.

Visit our Panasonic Web Site

<https://panasonic.net/cns/prodisplays/>

Table of Contents

Before use

- Illustrations and screens in this Operating Instructions are images for illustration purposes, and may be different from the actual ones.
- Descriptive illustrations in this Operating Instructions are created mainly based on the 55-inch model.

Important Safety Notice	4
Safety Precautions	6
Precautions for use	9
Accessories	11
Accessories Supply	11
Remote Control Batteries	12
Kensington security	13
Connections	13
AC cord connection and fixing / Cable fixing	13
Video equipment connection	16
Before connecting	17
HDMI 1 and HDMI 2 terminals connection	17
PC IN terminal connection	18
RS232 terminal connection	19
AUDIO OUT terminal connection	21
USB terminal connection	21
Identifying Controls	23
Display	23
Remote Control Transmitter	24
Basic Controls	25
Selecting the input signal	26
DISPLAY	27
Volume Adjustment	27
Sound mute On / Off	27
ASPECT Controls	28
On-Screen Menu Displays	29
Picture Adjustments	31
Audio Adjustment	33
Setup menu	34
Language	34
Network settings	35
HDMI-CEC control	36
EDID select	36
Position	37

No signal power off	37
No activity power off	37
Button lock	38
RC control lock	38
Front indicator light	38
Auto play	39
Information	39
All reset	39
Using Network Function	40
Necessary environment for computers to be connected	40
Example of network connection	40
Settings to connect to a LAN	41
Command-based control	41
Using “USB media file playback function” ...	42
Play file	43
Auto playback	43
Operations during play	44
Playing the pictures	45
Playing the music / video	46
Using HDMI-CEC function	47
Connection	47
Setting	47
Preset Signals	48
Troubleshooting	50
Specifications	52

To maintain compliance with EMC regulations, use shielded cables to connect to the following terminals: HDMI input terminal, D-sub input terminal and RS-232C input terminal.

WARNING:

- For permanently connected equipment, a readily accessible disconnect device shall be incorporated in the building installation wiring.
- For pluggable equipment, the socket-outlet shall be installed near the equipment and shall be easily accessible.

Note:

Image retention may occur. If you display a still picture for an extended period, the image might remain on the screen. However, it will disappear when a general moving picture is displayed for a while.

Trademark Credits

- Microsoft, Windows, Internet Explorer and Microsoft Edge are the registered trademarks or trademarks of Microsoft Corporation in the United States and/or other countries.
- Mac, macOS and Safari are the trademarks of Apple Inc. registered in the United States and other countries.
- HDMI, High-Definition Multimedia Interface and the HDMI Logo are trademarks or registered trademarks of HDMI Licensing Administrator, Inc. in the United States and other countries.
- Manufactured under license from Dolby Laboratories. Dolby, Dolby Audio and the double-D symbol are trademarks of Dolby Laboratories.

Even if no special notation has been made of company or product trademarks, these trademarks have been fully respected.

Important Safety Notice

WARNING

- 1) To prevent damage which may result in fire or shock hazard, do not expose this appliance to dripping or splashing.
Do not place containers with water (flower vase, cups, cosmetics, etc.) above the set. (including on shelves above, etc.)
No naked flame sources, such as lighted candles, should be placed on / above the set.
- 2) To prevent electric shock, do not remove cover. No user serviceable parts inside. Refer servicing to qualified service personnel.

3) **86-inch model**

Do not remove the earthing pin on the power plug. This apparatus is equipped with a three pin earthing-type power plug. This plug will only fit an earthing-type power outlet. This is a safety feature. If you are unable to insert the plug into the outlet, contact an electrician.

Do not defeat the purpose of the earthing plug.

4) **86-inch model**

To prevent electric shock, ensure the earthing pin on the AC cord power plug is securely connected.

CAUTION

This appliance is intended for use in environments which are relatively free of electromagnetic fields.

Using this appliance near sources of strong electromagnetic fields or where electrical noise may overlap with the input signals could cause the picture and sound to wobble or cause interference such as noise to appear.

To avoid the possibility of harm to this appliance, keep it away from sources of strong electromagnetic fields.

WARNING:

This equipment is compliant with Class A of CISPR32. In a residential environment this equipment may cause radio interference.

This equipment is not suitable for use in locations where children are likely to be present.

IMPORTANT INFORMATION: Stability Hazard

Never place a display in an unstable location. A display may fall, causing serious personal injury or death. Many injuries, particularly to children, can be avoided by taking simple precautions such as:

- Using cabinets or stands recommended by the manufacturer of the display.
- Only using furniture that can safely support the display.
- Ensuring the display is not overhanging the edge of the supporting furniture.
- Not placing the display on tall furniture (for example, cupboards or bookcases) without anchoring both the furniture and the display to a suitable support.
- Not placing the display on cloth or other materials that may be located between the display and supporting furniture.
- Educating children about the dangers of climbing on furniture to reach the display or its controls.

If the existing display is going to be retained and relocated, the same considerations as above should be applied.

86-inch model

IMPORTANT: THE MOULDED PLUG FOR YOUR SAFETY, PLEASE READ THE FOLLOWING TEXT CAREFULLY.

This display is supplied with a moulded three pin mains plug for your safety and convenience. A 10 amp fuse is fitted in this plug. Shall the fuse need to be replaced, please ensure that the replacement fuse has a rating of 10 amps and that it is approved by ASTA or BSI to BS1362.

Check for the ASTA mark  or the BSI mark  on the body of the fuse.

If the plug contains a removable fuse cover, you must ensure that it is refitted when the fuse is replaced.

If you lose the fuse cover the plug must not be used until a replacement cover is obtained.

A replacement fuse cover can be purchased from your local Panasonic dealer.

Do not cut off the mains plug.

Do not use any other type of mains lead except the one supplied with this display.

The supplied mains lead and moulded plug are designed to be used with this display to avoid interference and for your safety.

If the socket outlet in your home is not suitable, get it changed by a qualified electrician.

If the plug or mains lead becomes damaged, purchase a replacement from an authorized dealer.

WARNING : — THIS DISPLAY MUST BE EARTHED

How to replace the fuse.

Open the fuse compartment with a screwdriver and replace the fuse.

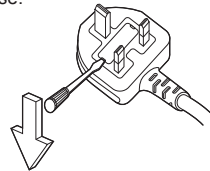

75-inch model

65-inch model

55-inch model

50-inch model

43-inch model

IMPORTANT: THE MOULDED PLUG FOR YOUR SAFETY, PLEASE READ THE FOLLOWING TEXT CAREFULLY.

This display is supplied with a moulded three pin mains plug for your safety and convenience. A 5 amp fuse is fitted in this plug. Shall the fuse need to be replaced, please ensure that the replacement fuse has a rating of 5 amps and that it is approved by ASTA or BSI to BS1362.

Check for the ASTA mark  or the BSI mark  on the body of the fuse.

If the plug contains a removable fuse cover, you must ensure that it is refitted when the fuse is replaced.

If you lose the fuse cover the plug must not be used until a replacement cover is obtained.

A replacement fuse cover can be purchased from your local Panasonic dealer.

Do not cut off the mains plug.

Do not use any other type of mains lead except the one supplied with this display.

The supplied mains lead and moulded plug are designed to be used with this display to avoid interference and for your safety.

If the socket outlet in your home is not suitable, get it changed by a qualified electrician.

If the plug or mains lead becomes damaged, purchase a replacement from an authorized dealer.

How to replace the fuse.

Open the fuse compartment with a screwdriver and replace the fuse.

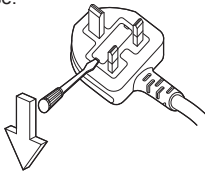

Safety Precautions

WARNING

■ Setup

When installing the wall hanging bracket, read the operating instructions supplied with it carefully and install properly.

We are not responsible for any product damage, etc. caused by failures in the installation environment for the pedestal or wall hanging bracket even during the warranty period.

Small parts can present choking hazard if accidentally swallowed. Keep small parts away from young children. Discard unneeded small parts and other objects, including packaging materials and plastic bags/sheets to prevent them from being played with by young children, creating the potential risk of suffocation.

Do not place the display on sloped or unstable surfaces, and ensure that the display does not hang over the edge of the base.

- The display may fall off or tip over.

Install this unit at a location with minimal vibration and which can support the weight of the unit.

- Dropping or falling of the unit may cause injury or malfunction.

Cautions for Wall or Pedestal Installation

- The installation should be performed by an installation professional. Installing the display incorrectly may lead to an accident that results in death or serious injury.
- When installing on a wall, the specified wall hanging bracket or a wall hanging bracket that conforms to VESA standards must be used.
- Some wall hanging brackets cannot be used due to the structure of the product. Check the product drawing before using.

86-inch model : VESA 600 × 400

75-inch model : VESA 400 × 400

65-inch model : VESA 400 × 200

55-inch model : VESA 400 × 200

50-inch model : VESA 400 × 200

43-inch model : VESA 200 × 200

(see page 9)

- Before installation, be sure to check if the mounting location has enough strength to support the weight of the display and the wall hanging bracket for anti drop.
- If you terminate the use of the product, ask a professional to remove it promptly.
- When mounting the display on the wall, prevent the mounting screws and power cable from contacting metal objects inside the wall. An electric shock may occur if they contact metal objects inside the wall.

■ When using the LCD Display

The display is designed to operate on 220 - 240 V ~, 50/60 Hz.

If problems or malfunction occur, stop using immediately.

If problems occur, unplug the power supply plug.

- Smoke or an abnormal odour come out from the unit.
- No picture appears or no sound is heard, occasionally.
- Liquid such as water or foreign objects got inside the unit.
- The unit has deformed or broken parts.

If you continue to use the unit in this condition, it could result in fire or electric shock.

- Unplug the power supply plug from the wall outlet, and then contact the dealer for repairs.
- To cut off the power supply to this display completely, you need to unplug the power supply plug from the wall outlet.
- Repairing the unit yourself is dangerous, and shall never be done.
- To enable to unplug the power supply plug immediately, use the wall outlet which you can reach easily.

Do not touch the unit directly by hand when it is damaged.

- Electric shock could occur.

Do not stick any foreign objects into the display.

- Do not insert any metal or flammable objects into the ventilations holes or drop them onto the display, as doing so can cause fire or electric shock.

Do not remove the cover (cabinet) or modify it.

- High voltages which can cause fire or electric shocks are present inside the display. For any inspection, adjustment and repair work, please contact your local Panasonic dealer.

Ensure that the mains plug is easily accessible.

86-inch model

The mains plug shall be connected to a mains socket outlet with a protective earthing connection.

Do not use any power supply cord other than that provided with this unit.

- Doing so may cause short-circuit, generates heat, etc., which could cause electric shock or fire.

Do not use the supplied power supply cord with any other devices.

- Doing so may cause short-circuit, generates heat, etc., which could cause electric shock or fire.

Clean the power supply plug regularly to prevent it becoming dusty.

- If there is a build up of dust on the plug, the resultant humidity may cause short-circuit, which could cause electric shock or fire. Unplug the power supply plug from the wall outlet and wipe it with a dry cloth.

Do not handle the power supply plug with wet hands.

- Doing so may cause electric shocks.

Securely insert the power supply plug (socket outlet side) and the power supply connector (main unit side) as far as it will go.

- If the plug is not fully inserted, heat may be generated which could cause fire. If the plug is damaged or the wall socket is loose, they shall not be used.

Do not do anything that may damage the power supply cord or the power supply plug.

- Do not damage the cable, make any modifications to it, place heavy objects on top of it, heat it, place it near any hot objects, twist it, bend it excessively or pull it. To do so may cause fire and electric shock. If the power cable is damaged, have it repaired at your local Panasonic dealer.

Do not touch the power supply cord or the plug directly by hand when they are damaged.

- Doing so may cause electric shock or fire due to short-circuit.

Keep the supplied R03/LR03 batteries out of reach of children. If accidentally swallowed, it will be harmful to the body.

- Please contact a doctor immediately in case you doubt that the child may have swallowed it.

To prevent the spread of fire, keep candles or other open flames away from this product at all times.



CAUTION

Do not place any objects on top of the display.

Ventilation should not be impeded by covering the ventilation openings with items such as newspapers, table cloths and curtains.

- Doing so may cause the display to overheat, which can cause fire or damage to the display.

For sufficient ventilation, see page 9.

Do not place the display where it may be affected by salt or corrosive gas.

- Doing so may cause the display to fall due to corrosion, and it may result in injury. Also, the unit may malfunction.

The following number of people are required to carry or unpack this unit.

86-inch model : **4 or more**

75-inch model 65-inch model 55-inch model

50-inch model 43-inch model : **2 or more**

- If this is not observed, the unit may drop, resulting in injury.

When disconnecting the power supply cord, always pull on the plug (socket outlet side) / the connector (main unit side).

- Pulling the cord may damage the cord, and it may cause electric shock or fire due to short-circuit.

Be sure to disconnect all cables before moving the display.

- If the display is moved while some of the cables are still connected, the cables may become damaged, and fire or electric shock could result.

Disconnect the power supply plug from the wall socket as a safety precaution before carrying out any cleaning.

- Electric shocks can result if this is not done.

Do not step on, or hang from the display or the Pedestal.

- They might tip over, or might be broken and it may result in injury. Pay special attention to the children.

Do not reverse the polarity (+ and -) of the battery when inserting.

- Mishandling the battery may cause its explosion or leakage, resulting in fire, injury or damage to surrounding properties.
- Insert the battery correctly as instructed. (see page 12)

Do not use batteries with the outer cover peeling away or removed.

- Mishandling the batteries may cause the batteries to short circuit, resulting in fire, injury or damage to surrounding properties.

Remove the batteries from the remote control transmitter when not using for a long period of time.

- The battery may leak, heat, ignite or burst, resulting in fire or damage to surrounding properties.

Remove exhausted batteries from the remote control immediately.

- Leaving the batteries unattended in it may cause battery leakage, heat or burst.

Do not burn or breakup batteries.

- Batteries must not be exposed to excessive heat such as sunshine, fire or the like.

Do not turn the display upside down.

Do not position the unit with its liquid crystal panel facing upright.

Precautions for use

Cautions when installing

Do not set up the display outdoors.

- The display is designed for indoor use.

Install this unit at a location which can support the weight of the unit.

- Dropping or falling of the unit may cause injury.

Environmental temperature to use this unit

- When using the unit where it is below 1 400 m (4 593 ft) above sea level: 0 °C to 40 °C (32 °F to 104 °F)
- When using the unit at high altitudes (1 400 m (4 593 ft) and higher and below 2 800 m (9 186 ft) above sea level): 0 °C to 35 °C (32 °F to 95 °F)

Do not install the unit where it is 2 800 m (9 186 ft) and higher above sea level.

- Failure to do so may shorten the life of the internal parts and result in malfunctions.

We are not responsible for any product damage, etc. caused by failures in the installation environment even during the warranty period.

Transport only in upright position!

- Transporting the unit with its liquid crystal panel facing upright or downward may cause damage to the internal circuitry.

Do not grab the liquid crystal panel.

- Do not forcibly press the liquid crystal panel, or push it with a pointed object. Applying a strong force to the liquid crystal panel will cause unevenness of the screen display, resulting in malfunction.

Do not install the product to a place where the product is exposed to direct sunlight.

- If the unit is exposed to direct sunlight even indoors, the temperature rise of the liquid crystal panel may cause malfunction.

Required space for ventilation

- When using the pedestal, leave a space of 10 cm (3 15/16") or more at the top, left and right, and 5 cm (1 31/32") or more at the rear, and also keep the space between the bottom of the display and the table surface.
- If using some other setting-up method (wall-hanging, etc.), follow the manual of it. (If there is no specific indication of installation dimension in the installation manual, leave a space of 10 cm (3 15/16") or more at the top, bottom, left and right, and 5 cm (1 31/32") or more at the rear.)

Minimum distance:

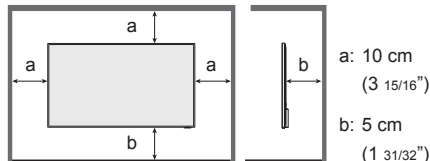

- Operation of this unit is guaranteed up to an ambient temperature of 40 °C (104 °F). When installing the unit in a case or chassis, be sure to provide adequate ventilation with a cooling fan or ventilation hole so that the surrounding temperature (inside the case or chassis) including the temperature of the front surface of the liquid crystal panel can be kept at 40 °C (104 °F) or less.

About the screws used when using a wall hanging bracket that conforms to VESA standards

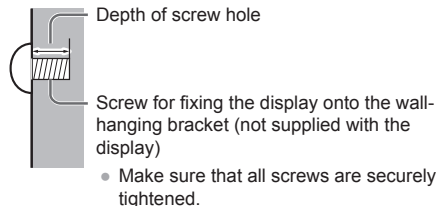

(View from the side)

Inch model	Screw pitch for installation	Depth of screw hole	Screw (quantity)
86	600 mm × 400 mm	18 mm	M8 (4)
75	400 mm × 400 mm	18 mm	M8 (4)
65	400 mm × 200 mm	17 mm	M6 (4)
55	400 mm × 200 mm	17 mm	M6 (4)
50	400 mm × 200 mm	17 mm	M6 (4)
43	200 mm × 200 mm	14 mm	M6 (4)

Note for connection

Removing and inserting the power cord and connection cables

- When the unit has been installed on the wall, if the power cord and connection cables are difficult to remove and insert, make connections first before installation. Be careful not to allow the cables to be entangled. After installation is completed, insert the power plug to the outlet.

When using

Red, blue or green dots on the screen are a liquid crystal panel-specific phenomenon. This is not a malfunction.

- Although the liquid crystal display is manufactured with high-precision technology, always-lighting dots or non-lighting dots may appear on the screen. This is not a malfunction.

Inch model	Dot omission ratio*
86, 75	0.00007% or less
65, 55, 50, 43	0.00005% or less

* Calculated in sub-pixel units according to the ISO09241-307 standard.

Depending on the temperature or humidity conditions, uneven brightness may be observed. This is not a malfunction.

- This unevenness will disappear while applying current continuously. If not, consult the distributor.

If the display is not going to be used for any prolonged length of time, unplug the power supply plug from the wall outlet.

Picture noise may occur if you connect / disconnect the cables connected to the input terminals you are currently not watching, or if you turn the power of the video equipment on / off, but it is not a malfunction.

Notes on Using Wired LAN

When setting up the display at a place, where electric static occurs often, take a sufficient antistatic measure before start using.

- When the display is used at a location, where static electricity occurs often, such as on a carpet, a wired LAN communication is disconnected more often. In that case, remove static electricity and the noise source that may cause problems with an antistatic mat, and re-connect the wired LAN.
- In rare cases, the LAN connection is disabled due to static electricity or noise. In that case, turn off the power of the display and the connected devices once and then re-turn on the power.

The display may not work properly due to strong radio wave from the broadcast station or the radio.

- If there is any facility or equipment, which outputs strong radio wave, near the installation location, set up the display at a location sufficiently far from the source of the radio wave. Or, wrap the LAN cable connected to the LAN terminal by using a piece of metal foil or a metal pipe, of which is grounded at both ends.

Request Regarding Security

When using this unit, take safety measures against the following incidents.

- Personal information being leaked via this unit
- Unauthorized operation of this unit by a malicious third party
- Interfering or stopping of this unit by a malicious third party

Take sufficient security measures.

- Set a password for the LAN control and restrict the users who can log in.
- Make your password difficult to guess as much as possible.
- Change your password periodically.
- Panasonic Corporation or its affiliate companies will never ask for your password directly. Do not divulge your password in case you receive such inquiries.
- The connecting network must be secured by a firewall, etc.
- When disposing the product, initialize the data before disposing.

Cleaning and maintenance

First, remove the mains plug from the mains socket.

Gently wipe the surface of the liquid crystal panel or cabinet by using a soft cloth to remove dirt.

- To remove stubborn dirt or fingerprints on the surface of the liquid crystal panel, dampen a cloth with diluted neutral detergent (1 part detergent to 100 parts water), wring out the cloth firmly, and then wipe away the dirt. Finally, wipe away all the moisture with a dry cloth.
- If water droplets get inside the unit, operating problems may result.

Note

- The surface of the liquid crystal panel is specially treated. Do not use a hard cloth or rub the surface too hard, otherwise this may cause scratches on the surface.

Usage of a chemical cloth

- Do not use a chemical cloth for the liquid crystal panel surface.
- Follow the instructions for the chemical cloth to use it for the cabinet.

Avoid contact with volatile substances such as insect sprays, solvents and thinner.

- This may cause damage to the cabinet or cause peeling of the paint. Furthermore, do not leave it in contact with a rubber or PVC substance for a long time.

Disposal

When disposing the product, ask your local authority or dealer about the correct methods of disposal.

Accessories

Accessories Supply

Check that you have the accessories and items shown.

Remote Control Transmitter × 1

- DPVF2599ZA/X1



Batteries for the Remote Control Transmitter × 2 (R03/LR03 type)

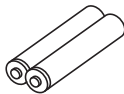

Power supply cord

TH-86CQ1W
(Approx. 2 m)

- DPVF2717ZA/X1

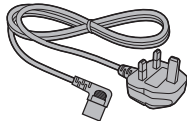

- DPVF2718ZA/X1

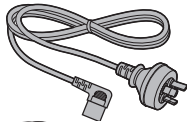

- DPVF2719ZA/X1

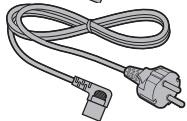

TH-75CQ1W
TH-65CQ1W
TH-55CQ1W
TH-50CQ1W
TH-43CQ1W
(Approx. 1.8 m)

- TZSH03039

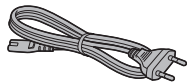

- TZSH03040

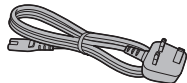

- DPVF2792ZA/X1

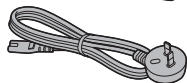

Clamper (large) × 2

- DPVF1654ZA

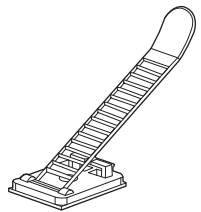

Clamper (small) × 1

- DPVF1653ZA



Attention

- Store small parts in an appropriate manner, and keep them away from young children.
- The part numbers of accessories are subject to change without notice. (The actual part number may differ from the ones shown above.)
- In case you lost accessories, please purchase them from your dealer. (Available from the customer service)
- Dispose the packaging materials appropriately after taking out the items.

Remote Control Batteries

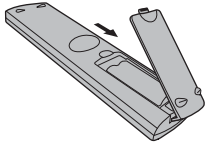

Open the battery cover.

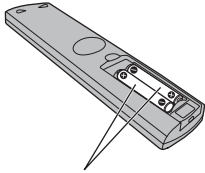

Insert batteries and close the battery cover.

(Insert starting from the ⊖ side.)

R03/LR03 type

Note

- Incorrect installation of the batteries can cause battery leakage and corrosion that will damage the remote control.
- Disposal of batteries should be done in an environment-friendly manner.

Take the following precautions.

1. Batteries shall always be replaced as a pair.
2. Do not combine a used battery with a new one.
3. Do not mix battery types (example; manganese dioxide battery and alkaline battery etc.).
4. Do not attempt to charge, disassemble or burn used batteries.
5. Do not burn or breakup batteries.

Moreover, batteries must not be exposed to excessive heat such as sunshine, fire or the like.

Kensington security

The security slot of this unit is compatible with the Kensington security slot.

65-inch model

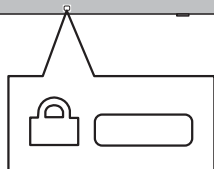
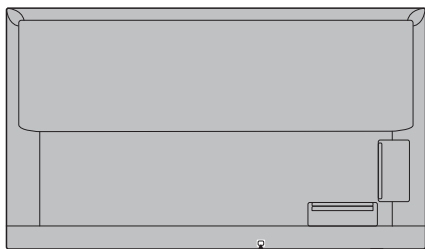

55-inch model

50-inch model

43-inch model

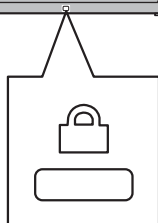
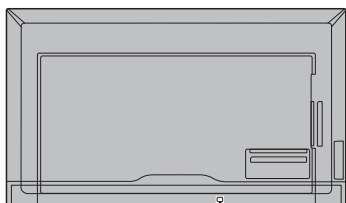

Connections

AC cord connection and fixing / Cable fixing

86-inch model

Back of the unit

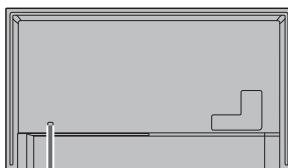

AC cord fixing

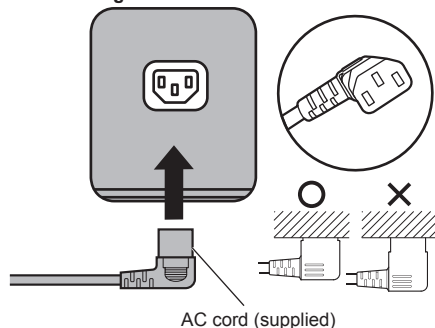

Plug the connector into the display unit.

Note

- When disconnecting the AC cord, be absolutely sure to disconnect the AC cord plug at the socket outlet first.
- The supplied AC cord is for this unit exclusive use. Do not use this for other purposes.

75-inch model 65-inch model 55-inch model
 50-inch model 43-inch model

Back of the unit

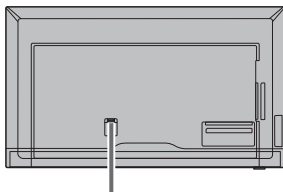

Insert the AC cord securely all the way seated on the back side of the unit.

75-inch model

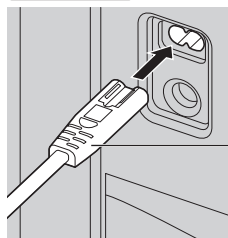

AC cord
(supplied)

65-inch model

55-inch model

50-inch model

43-inch model

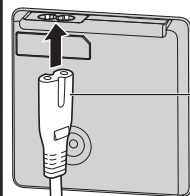

AC cord
(supplied)

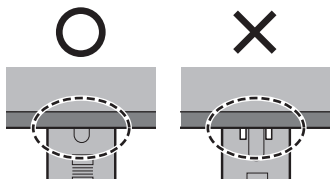

Insert the plug until the line is hidden.

Class II equipment

Note

- When disconnecting the AC cord, be absolutely sure to disconnect the AC cord plug at the socket outlet first.
- The supplied AC cord is for this unit exclusive use. Do not use this for other purposes.

Cable fixing

Note

- 3 clampers are supplied with this unit. Fix the cables at 3 locations using the holes for clampers as shown below.

If you need more clampers, purchase them from your dealer. (Available from the customer service)

86-inch model 75-inch model

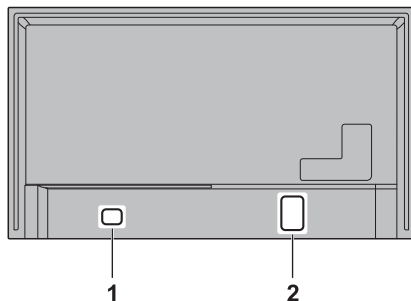

65-inch model

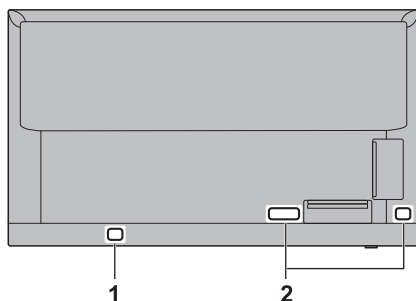

55-inch model 50-inch model 43-inch model

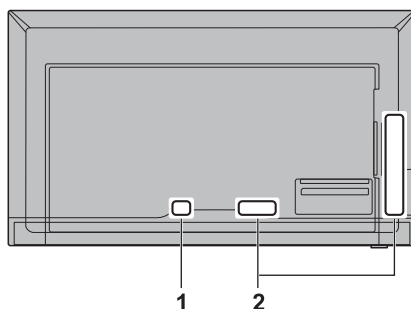

- 1 For AC cord: clamper (small)
- 2 For signal cable: clamper (large) × 2

1. Attach the clumper

Note

- Wipe off dirt, such as dust, water and oil on the attachment surface, and affix the clumper on the attachment surface by pushing it firmly.
- Once the clumper is affixed, it cannot be reused. Be sure to confirm the attaching position before affixing it.

Remove the tape at the back, and affix the clumper on the flat surface.

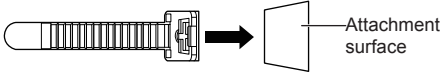

2. Bundle the cables

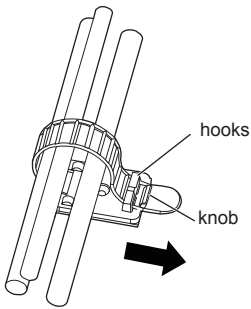

To loosen:

Remove the band from the knob, and pull out the band tip.

Video equipment connection

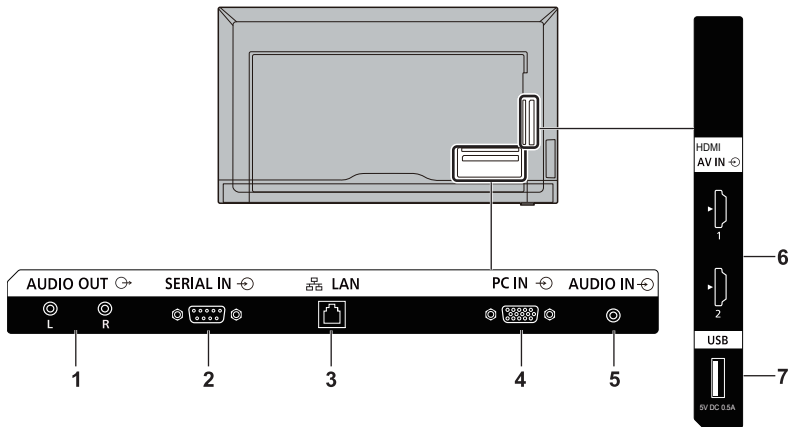

1 AUDIO OUT: Analogue Audio Output Terminal
Connect to audio equipment with analogue audio input terminal.
(see page 21)

2 SERIAL IN: SERIAL Input Terminal
Control the display by connecting to PC.
(see page 19)

3 LAN: LAN Terminal
Control the display by connecting to Network.
(see page 40)

4 PC IN: PC Input Terminal
Connect to video terminal of PC.
(see page 18)

5 AUDIO IN: Audio Input Terminal

6 HDMI 1, HDMI 2: HDMI Input Terminal
Connect to video equipment such as VCR or DVD player, etc.

- Use a commercially available HDMI cable (conforming to the HDMI standard) that supports 4K

7 USB: USB Terminal
Connect the USB memory device to the USB port.

Before connecting

- Before connecting cables, carefully read the operating instructions for the external device to be connected.
- Turn off the power of all devices before connecting cables.
- Take note of the following points before connecting the cables. Failure to do so may result in malfunctions.
 - When connecting a cable to the unit or a device connected to the unit itself, touch any nearby metallic objects to eliminate static electricity from your body before performing work.
 - Do not use unnecessarily long cables to connect a device to the unit or to the unit body. The longer the cable, the more susceptible to noise it becomes. Since using a cable while it is wound makes it act like an antenna, it is more susceptible to noise.
 - When connecting cables, insert them straight into the connecting terminal of the connecting device so that the ground is connected first.
- Acquire any cable necessary to connect the external device to the system that is neither supplied with the device nor available as an option.
- If the outer shape of the plug of a connection cable is large, it may come in contact with the periphery such as a back cover or the plug of an adjacent connection cable. Use a connection cable with the suitable plug size for the terminal alignment.
- When connecting the LAN cable with plug cover, be aware that the cover may come in contact with the back cover and it may be difficult to disconnect.
- Some PC models are not compatible with the unit.
- Use cable compensator when you connect devices to the unit using long cables. Otherwise the image may not be displayed properly.
- Refer to "Preset Signals" (see page 48) for the types of video signals that can be displayed with the unit.

HDMI 1 and HDMI 2 terminals connection

Note

- Video equipment and HDMI cable shown are not supplied with this unit.
- Connect the equipment complying with the HDMI standard.
- Some HDMI equipment may not be able to display picture.
- This display does not support VIERA LINK.

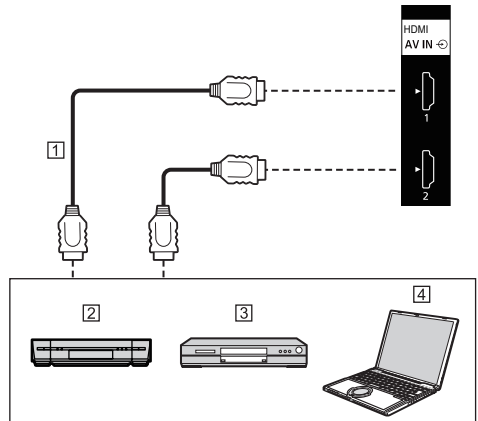

- ① HDMI cable (commercially available)
- ② Video Cassette Recorder
- ③ DVD Player
- ④ PC

Pin assignments and signal names for HDMI Terminal

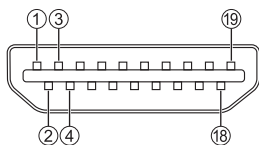

Pin No.	Signal name
①	T.M.D.S Data2 +
②	T.M.D.S Data2 Shield
③	T.M.D.S Data2 -
④	T.M.D.S Data1 +
⑤	T.M.D.S Data1 Shield
⑥	T.M.D.S Data1 -
⑦	T.M.D.S Data0 +
⑧	T.M.D.S Data0 Shield
⑨	T.M.D.S Data0 -
⑩	T.M.D.S Clock +
⑪	T.M.D.S Clock Shield
⑫	T.M.D.S Clock -
⑬	CEC
⑭	
⑮	SCL
⑯	SDA
⑰	DDC/CEC Ground
⑱	+5V DC
⑲	Hot Plug Detect

PC IN terminal connection

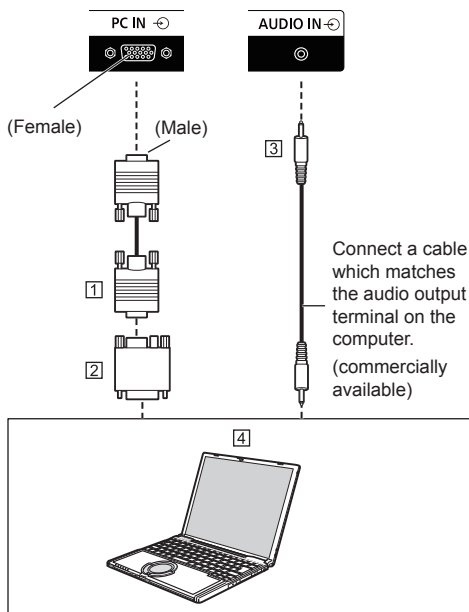

- ① Mini D-sub 15p cable (commercially available)
- ② Conversion adapter (if necessary) (commercially available)
- ③ Stereo mini plug (M3) cable (commercially available)
- ④ PC

The type of computer signal that can be connected

- With regard to the typical PC input signals that are described in "Preset Signals" (see page 48), adjustment values such as for the standard picture positions and sizes have already been stored in this unit.

(Computer signals which can be input are those with a horizontal scanning frequency of 31 to 83 kHz and vertical scanning frequency of 56 to 76 Hz.)

- If signals outside the range of supported frequencies are input, normal images cannot be displayed. Note that some images may not be correctly displayed even if signals are within the range.
- If the PC screen is not displayed, check if the image signal of the PC meets "Preset Signals" (see page 48), and then change the settings. For power-saving purpose, image output may be OFF on a notebook computer. In this case, it may be set to ON with function key operation etc. of the computer. (Refer to the manual of the computer.)

Note

- Additional computer, cables and conversion adapter shown are not supplied with this set.
- If the computer being connected is not DDC2B-compatible, you will need to make setting changes to the computer at the time of connection.
- When connecting a computer equipped with a D-sub15 pin terminal or a Mac, use a commercially sold conversion adapter as necessary.
 - * There is no need to use an adapter for computers with DOS/V compatible Mini D-sub 15P terminal.
- Do not set the horizontal and vertical scanning frequencies for PC signals which are above or below the specified frequency range.
- For audio, the AUDIO IN terminal can be used.

Pin assignments and signal names for PC Input Terminal (Mini D-sub 15P)

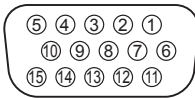

Pin No.	Signal Name
①	Red video signal input
②	Green video signal input
③	Blue video signal input
④	NC (not connected)
⑤	GND
⑥	GND for red video signal
⑦	GND for green video signal
⑧	GND for blue video signal
⑨	+5 V DC
⑩	GND (Ground)
⑪	NC (not connected)
⑫	DDC data
⑬	Hsync Signal input
⑭	Vsync Signal input
⑮	DDC Clock

RS232 terminal connection

The RS232 terminal conforms to the RS-232C interface specification, so that the display can be controlled by a computer which is connected to this terminal.

Note

- Additional computer and cables shown are not supplied with this set.

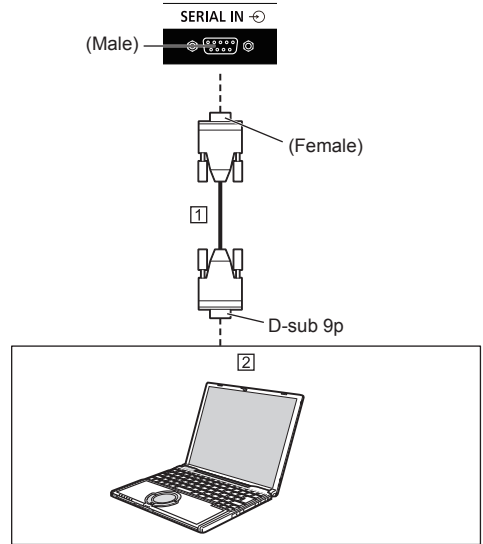

- ① RS-232C Straight cable (commercially available)
- ② PC

Note

- Select the RS-232C straight cable for communication used for connecting RS232 terminal and computer according to the computer you are using.

Pin assignments and signal names for SERIAL Terminal

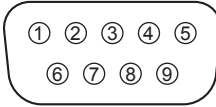

Pin No.	Signal Name
①	NC (not connected)
②	Received data
③	Transmitted data
④	NC (not connected)
⑤	GND (Ground)
⑥	NC (not connected)
⑦	NC (not connected)
⑧	NC (not connected)
⑨	NC (not connected)

These signal names are those of computer specifications.

Communication parameters

- Signal level: RS-232C compliant
- Synchronization method: Asynchronous
- Baud rate: 9 600 bps
- Parity: None
- Character length: 8 bits
- Stop bit: 1 bit
- Flow control: None

Basic format for control data

The transmission of control data starts with a STX signal, followed by the command, the parameters, and lastly an ETX signal in that order. If there are no parameters, the colon ":" does not need to be sent.

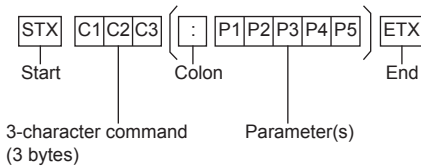

Command

Command	Parameter	Control details
PON	(None)	Power ON
POF	(None)	Power OFF
AVL	***	VOLUME 000 - 100
AMT	0	Audio MUTE OFF
	1	Audio MUTE ON
IMS	(None)	Input select (toggle)
	HM1	HDMI 1 input (HDMI1)
	HM2	HDMI 2 input (HDMI2)
	PC1	PC IN input (PC)
	UD1	USB input (USB)
DAM	FULL	Full
	NORM	Normal
	NATV	Native
	ZOOM	Zoom

Note

- If an incorrect command is sent, this unit will reply an "ER401" command to the computer.
- If communication has not been established for reasons such as a bad connection between the computer and display, nothing is returned (not even ER401).
- "ER401" may be returned when a command cannot be received correctly due to interference from the surrounding environment.
Please ensure that the system or software resends the command if this occurs.

Communication interval

After getting the feedback, then you can continue the following commands.
Suggest setting a timeout for the command response. (specify 10 seconds or longer)

If multiple commands are transmitted, be sure to wait for the response for the first command to come from this unit before sending the next command.

- When sending a command which does not require parameter, a colon (:) is not needed.
- Consult your local Panasonic dealer for detail instructions on command usage.

For more details, visit the following web site.

<http://panasonic.net/cns/prodisplays/>

AUDIO OUT terminal connection

Note

- Audio equipment and the cable shown are not supplied with this set.

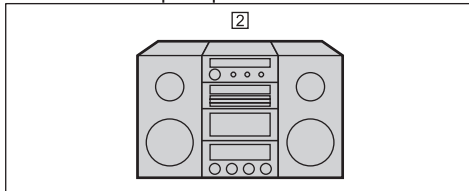
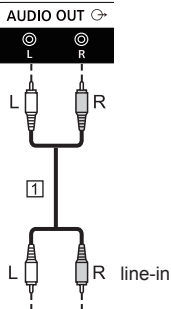

- ① Stereo audio cable (commercially available)
② Audio equipment

Note

- To output sound from AUDIO OUT terminal of the unit, be sure to set [Audio output] or [Speaker] in the [Audio] menu. (see page 33)

USB terminal connection

Connect a USB memory device to the USB port.

Note

- Do not connect a USB device other than a USB memory device.
- Turn off the power of the display when removing a USB memory device.
- If the power is turned off or the USB memory device is removed while accessing data in the USB memory device, the stored data may be destroyed. The access indicator of the USB memory device blinks during data access.

■ Supported USB memory device

File System	FAT16/32
Capacity	Up to 32 GB (maximum file size 4 GB)

Note

- Do not use a USB memory device with a security function or a write protection function.
- Use a USB memory device with a shape that can be inserted in the USB port. Some USB memory devices with special shapes cannot be inserted. Do not forcibly insert a USB memory device. This may damage the connector and cause failure.



Pin assignments and signal names for USB Terminal

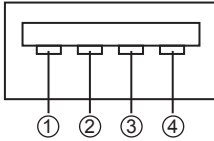

Pin No.	Signal name
①	+5 V DC
②	DATA -
③	DATA +
④	GND (Ground)

Power of up to 5 V / 0.5 A can be supplied to an external device when the picture is displayed.

Note

- If the direct connection to this unit is not possible due to the size of a stick PC, etc. use a commercially sold extension cable.
- Depending on the type of a USB memory device, it may come in contact with the periphery such as a back cover, and cannot be attached. Use a USB memory device connectable to this unit.
- When connecting the USB memory device, confirm the orientation of the plug to prevent damage to the terminal.
- When removing the USB memory device, note the following.
 - When the access indicator of the connected USB memory device is blinking, it shows the display is loading the data. Do not remove the USB memory device while blinking.
 - Depending on the USB memory device, the access indicator may remain blinking even when it is not being accessed, or the device is not equipped with an access indicator function, etc. In this case, remove the USB memory device after confirming the following ① or ②.
 - ① Switch the input to an input other than [USB], and confirm that the functions that access USB memory device are finished.
 - ② Turn the unit off.
 - Do not frequently repeat connecting/disconnecting the USB memory device. Wait at least 5 seconds after connection, and then remove the USB memory device. Before reconnection, wait at least 5 seconds. A certain length of time is required so that the display can recognise that the USB memory device is switched for connection or disconnection.
 - If the power of this unit is turned off or the USB memory device is removed accidentally while accessing data, the data may not be accessed next time the USB memory device is used.

In such a case, turn the power of the main unit off and on.

Identifying Controls

Display

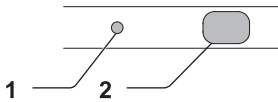
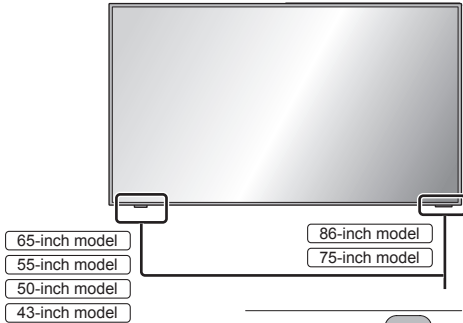

1 Power LED

The Power Indicator will light.

When the power of the unit is ON

(Power button (⏻) (Unit): ON)

- Picture is displayed: Green
- When the unit enters the standby mode: Red

2 Remote control sensor

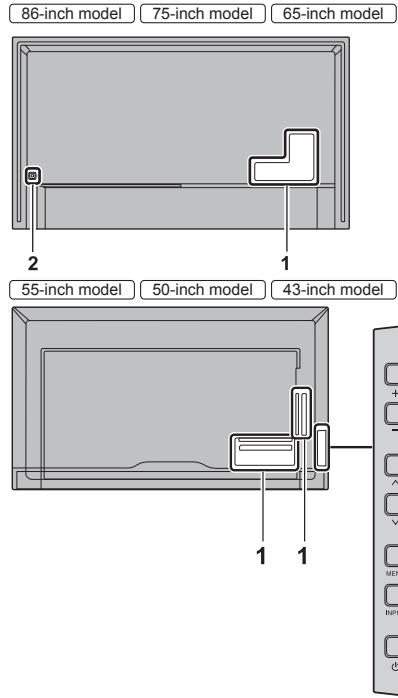

1 External input / output terminal

Connects to video equipment, PC, etc. (see page 16)

2 Power button (⏻) (Unit)

Turns the power On / Off.

3 INPUT (Unit)

Selects the connected device. (see page 26)

Configures the item on menu screen.

4 MENU (Unit)

Displays the menu screen. (see page 29)

5 ^ (Unit) / v (Unit)

Selects the setting item on menu screen. (see page 29)

6 + (Unit) / - (Unit)

Adjusts the volume. (see page 27)

On the main screen, switches settings or adjusts settings level. (see page 29)

Note

- To output sound from the built-in speakers of the unit, be sure to set [Speaker] in the [Audio] menu. (see page 33)

Remote Control Transmitter

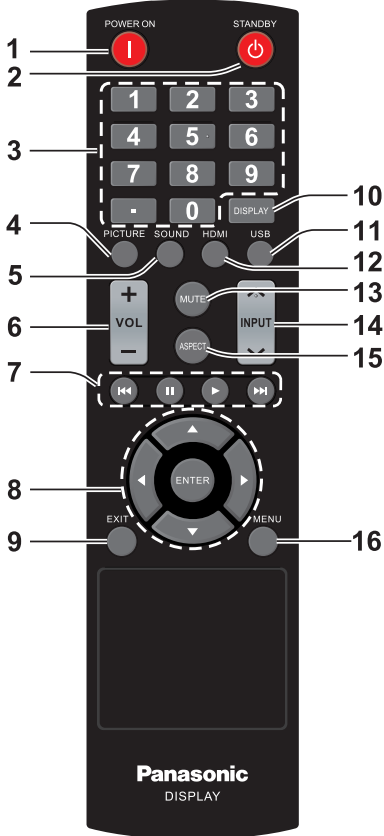

1 POWER ON button (I)

- Turns the power on (Picture is displayed) when the display is turned off (Standby condition).

2 STANDBY button (⏻)

- Turns the power off (Standby condition) when the display is turned on.

3 Numeric buttons (0 - 9) / ·

- Input numbers in LAN settings.

4 PICTURE

- Adjust Picture mode. (see page 31)

5 SOUND

- Changes the Sound mode. (see page 33)

6 VOL + / VOL -

- Adjusts sound volume level. (see page 27)

7 Navigation keys (◀, ⏮, ⏭, ▶, ▶▶)

- Used in the USB menu and HDMI CEC function.

8 ENTER / Cursor buttons (▲, ▼, ◀, ▶)

- Used to operate the menu screens. (see page 29)

9 EXIT

- Turns off the menu screens. (see page 29)

10 DISPLAY

- Displays information of displayed signal.

11 USB

- Switches to USB device viewing.

12 HDMI

- Selects to fit the input signal.

13 MUTE

- Sound mute on / off. (see page 27)

14 INPUT \wedge / \vee

- Switches input to display on the screen. (see page 26)

15 ASPECT

- Change aspect ratio. (see page 28)

16 MENU

- Press to open the OSD menu. (see page 29)

Note

- In this manual, buttons of the remote control and the unit are indicated as < >.

(Example: <INPUT>.)

The operation is mainly explained indicating the remote control buttons but you can also operate with the buttons on the unit when there are the same buttons.

Basic Controls

<Power button (⏻) (Unit)>

(Back of the unit)

86-inch model

75-inch model

65-inch model

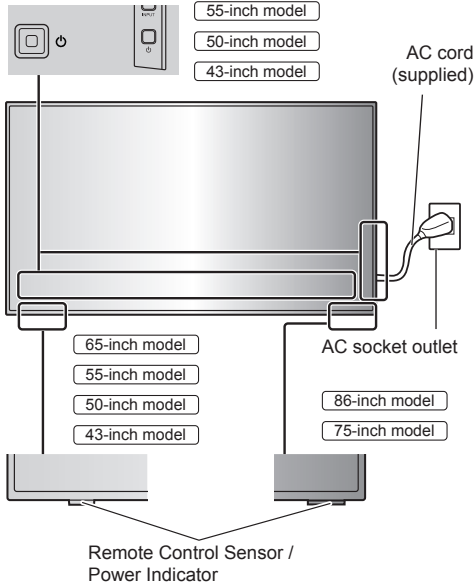

Operate pointing the remote control directly at the unit's Remote Control Sensor.



Note

- Do not put an obstacle between the remote control sensor of the main unit and the remote control.
- Operate the remote control in front of the remote control sensor or from the area where the sensor can be seen.
- When directly aiming the remote control at the remote control sensor of the main unit, the distance from the front of remote control sensor should be approx. 7 m or less. Depending on the angle, the operation distance may be shorter.
- Do not subject the remote control sensor of the main unit to the direct sunlight or strong fluorescent light.

1 Connect the AC cord plug to the display.

(see page 13)

2 Connect the plug to the socket outlet.

Note

- When disconnecting the AC cord, be absolutely sure to disconnect the AC cord plug at the socket outlet first.
- The settings may not be saved if the power plug is disconnected immediately after changing settings with on-screen menu. Disconnect the power plug after a enough period of time. Or, disconnect the power plug after turning the power off with the remote control, RS-232C control or LAN control.

3 Press the <Power button (⏻)> on the unit to turn the power of the unit on.

- Power Indicator: Green (Picture is displayed.)
- When the power of the unit is on, the power indicator lights up and remote control operation is possible.
- When the power indicator is lit, it is not necessary to press the <Power button (⏻)> on the unit. Operate the remote control so that the power indicator turns green (picture is displayed).

■ To turn the power ON/OFF with the remote control

To turn the power on

- When the power of the unit is on (Power Indicator - red), press <POWER ON button (I)> then the picture will be displayed.
- Power Indicator: Green (Picture is displayed.)

To turn the power off (Standby condition)

- When the power of the unit is on (Power Indicator - green), press <STANDBY button (⏻)>, then the power will be turned off.
- Power Indicator: Red (standby)

Note

- After the power plug is disconnected, the power indicator may remain lit for a while. This is not a malfunction.
- Press the <Power button (⏻) (Unit)> on the unit to turn the unit off, when the power of the unit is turned on or in standby mode.

Selecting the input signal

Select the signals input to the unit.

Press <INPUT> or <INPUT (Unit)>.



Unit

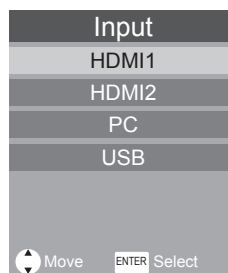

[HDMI1]: HDMI 1 terminal, HDMI input

[HDMI2]: HDMI 2 terminal, HDMI input

[PC]: PC Input Terminal

[USB]: USB terminal, USB input

DISPLAY

It is possible to check the input information.

Press **<DISPLAY>**.

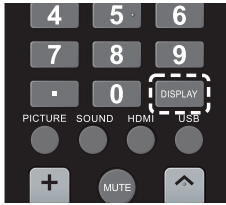

Current setting status will be displayed.

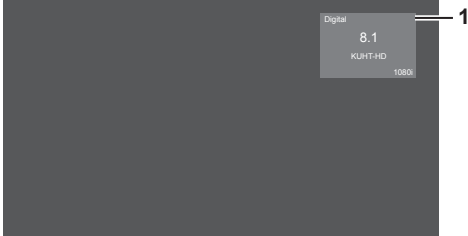

1 Signal type / Signal resolution

- When there is no video signal to the selected input, [No signal] is displayed for about 60 seconds at the end.

Volume Adjustment

Press **<VOL +>** **<VOL ->** or **<+ (Unit)>** **<- (Unit)>** to adjust volume.

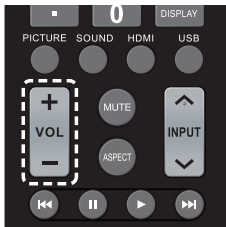

Unit



- The current sound volume level is memorised even if the power is turned off.

Sound mute On / Off

It is useful when you want to mute the sound temporarily, for example, when answering the phone or door.

Press **<MUTE>**.

-  appears on the screen and the sound is muted. Press again to reactivate the sound.



- It is also reactivated when the power is turned on / off or the volume level is changed.

ASPECT Controls

Press <ASPECT> to move through the aspect options:



[Normal] → [Zoom] → [Full] → [Native]

Note

- The aspect mode is memorised separately for each input terminal.

List of Aspect Modes

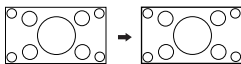
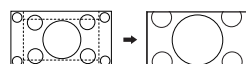
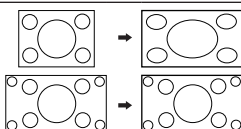
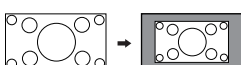
Aspect mode	Description
Normal	<p>Picture → Enlarged screen</p>  <p>Pictures are displayed with the aspect ratio of input signals.</p>
Zoom	 <p>Letterboxed pictures with a 16:9 aspect ratio are enlarged vertically and horizontally to fill the screen. The top and bottom edges as well as the left and right edges of the pictures are cut off.</p>
Full	 <p>Pictures are displayed filling the screen.</p>
Native	 <p>According to the input signals to display the picture. Refer to "Preset Signals" (see page 48) for the applicable input signal that can be displayed.</p>

Note

- [Native] cannot be used for video signals exceeding the resolution of 3 840 x 2 160 and for the interlace signal.
- [Zoom] cannot be used with PC input.
- Using this display's screen-size switching function to compress or expand the screen for commercial or public viewing in establishments like cafes or hotels may infringe on the rights of the creators, as protected by Copyright Law, so please be careful.
- The appearance of the original video may change if you select a screen size with a different aspect ratio than the original image (e.g. video input from external equipment).
- When 4:3 video is viewed with the whole screen using the screen-size switching function of this display, the edge of the video may be lost or appear distorted. If you wish to respect the creator's intentions, set the screen size to [Normal].
- When playing commercial software, parts of the image (like subtitles) may be cropped. In this case select the optimal screen size using the screen-size switching function of this display. With some software, there may be noise or distortion at the edges of the screen. This is due to the characteristics of the software, and is not a malfunction.
- Depending on the original video size, black bands may remain at the edges of the screen.

On-Screen Menu Displays

1 Display the menu screen.

Remote Control

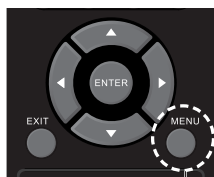

Press to select.

Unit

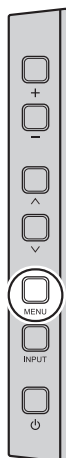

2 Select the item.

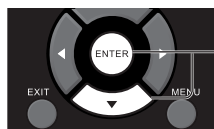

Press to select.



Press to select.

(Example: [Picture] menu)

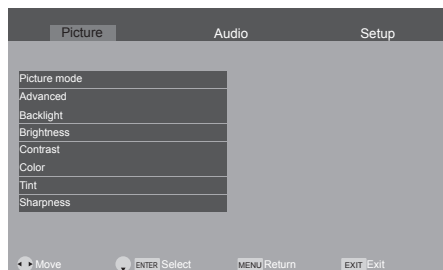

To display the submenu, press <ENTER>.

3 Set.

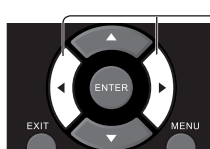

Press to set.



Press to set.

4 Exit from the menu.

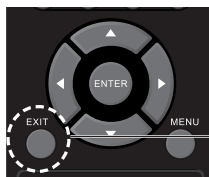

Press to exit the menu.

Press <MENU> to return to the previous screen.

Alternatively, press the button selected in step 1 to exit from the menu.



Press

Note

- When changing the settings of the display, picture or sound disturbance may occur temporarily. This is not a malfunction.

Menu display list

- Menu that cannot be adjusted is greyed out.
Adjustable menu changes depending on signal, input and menu setting.

[Picture] menu

(see page 31)

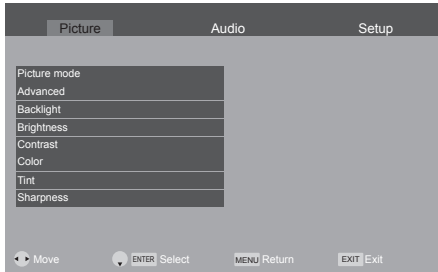

[Audio] menu

(see page 33)

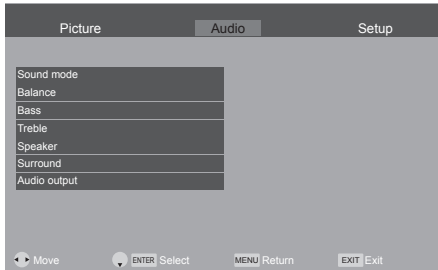

[Setup] menu

(see page 34 – 39)

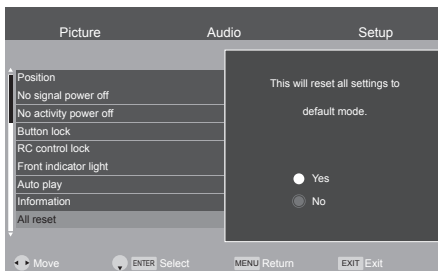
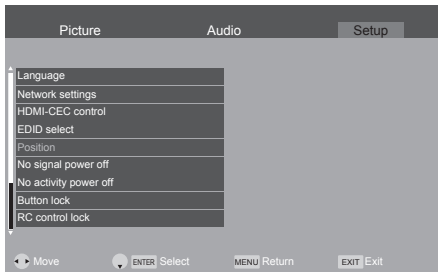

Picture Adjustments

1 Press <MENU> to display the [Picture] menu.

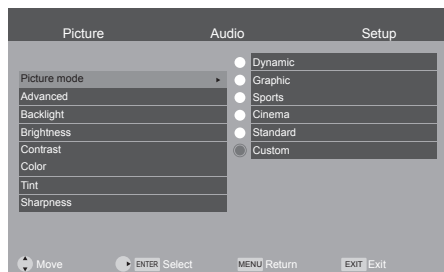

2 Select the item to adjust with <▲▼>.

- Menu that cannot be adjusted is greyed out.

3 Adjust with <◀▶>.

4 Press <EXIT> to exit from adjust mode.

■ To return to the previous screen

Press <MENU>.

[Picture mode] This menu switches to easy-to-see pictures suitable to the picture source or environment where this unit is used.

[Dynamic]:

Improves contrast and sharpness for viewing in a bright room.

[Graphic]:

Suitable for PC input.

[Sports]:

Suitable for sports matches.

[Cinema]:

Improves the performance of contrast, black and colour reproduction for watching movies in a darkened room.

[Standard]:

For viewing in standard (evening lighting) environments.

[Custom]:

Adjusts the manually by using the equaliser to suit your favourite picture quality.

Note

- [Dynamic]/[Sports]/[Cinema] cannot be selected for the PC input or RGB signal with HDMI input.

[Advanced]

Selects advanced video settings.

[Aspect ratio]:

Changes the screen size. (see page 28)

[Overscan]:

Sets the scan mode used for video input.

[Dynamic backlight control]:

Optimizes the backlight brightness to enhance contrast and reduce total power consumption.

[Color temperature]:

Adjusts colour tone. ([10700K], [9300K], [6500K] and [Native])

Note

- Emphasizes red when the numerical value of [Color temperature] is small, and emphasizes blue when it is big.
- [Native] is a colour tone of the panel element.

[Noise reduction]:

Sets to reduce the video noise.

[Dynamic contrast]:

Automatically adjusts the contrast by determining the changes in the use of colours for images that constantly change, such as motion pictures.

- The adjustment operation may not be smooth depending on the image. In this case select [Off].

[Cinema reality]:

Attempts to reproduce a more natural interpretation of sources such as movie pictures, which are recorded by 24 frames per second.

- The function only affects 480i, 576i, 1080i 50Hz and 1080i 60Hz signal during HDMI input.

[Motion smoother]:

Selects smooth levels of fast motion scenes. (only for [86-inch model]

[75-inch model] [65-inch model])

[Backlight]	Selects the proper brightness and density for the room. Less ↔ More
[Brightness]	Adjusts the entire brightness of the video signals. Less ↔ More
[Contrast]	Adjusts for easier viewing of dark pictures. Less ↔ More
[Color]	Adjusts colour saturation. Less ↔ More
[Tint]	Adjusts hue of skin colour. Reddish ↔ Greenish
[Sharpness]	Adjusts picture sharpness. Less ↔ More

Audio Adjustment

1 Press <MENU> and <▶> to display the [Audio] menu.

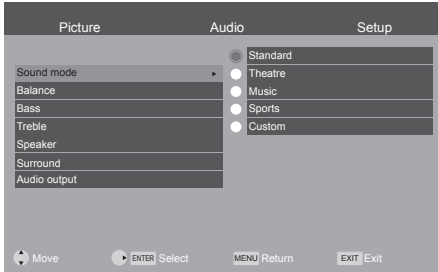

2 Select the item to adjust with <▲▼>.

- Menu that cannot be adjusted is greyed out.

3 Adjust with <◀▶>.

4 Press <EXIT> to exit from adjust mode.

■ To return to the previous screen

Press <MENU>.

[Sound mode] Selects your favourite sound mode.

[Standard]:

Provides the suitable sound quality for all types of scenes.

[Theatre]:

Sets up and get the sound through your Home Theatre systems.

[Music]:

Improves sound quality for watching music videos, etc.

[Sports]:

Improves sound quality for watching sports program, etc.

[Custom]:

Adjusts the sounds manually by using the equaliser to suit your favourite sound quality.

[Balance] Adjusts left and right volumes.

[Bass] Adjusts low pitch sounds.

[Treble] Adjusts high pitch sounds.

[Speaker] Internal speakers.

[Enable]:

Internal speakers enable.

[Disable]:

Internal speakers disable.

[Surround]

[Off]:

Normal sound

[On]:

Surround sound

[Audio output]

Sets the volume of sound output from the audio output terminals.

[Fixed]:

Fixes the sounds.

[Variable]:

Adjusts the volume by using the VOL button.

Note

- [Bass] and [Treble] settings are memorised separately for [Standard], [Theatre], [Music] and [Sports] in [Sound mode].

Setup menu

1 Press <MENU> and <▶> to display the [Setup] menu.

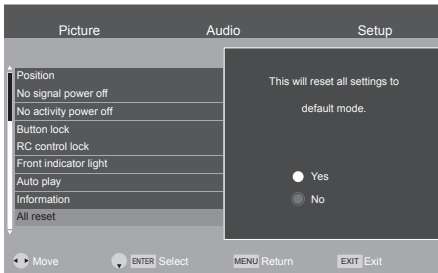
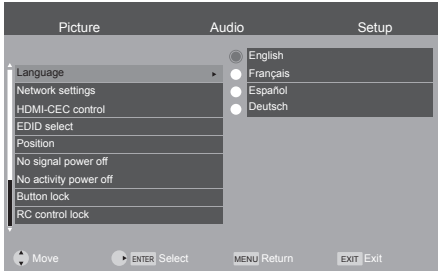

2 Select the item to set with <▲▼>.

- Menu that cannot be adjusted is greyed out. Adjustable menu changes depending on signal input and menu setting.

3 Set with <◀▶>.

4 Press <EXIT> to exit from adjust mode.

■ To return to the previous screen

Press <MENU>.

- [Language]** Changes language for on-screen displays.
- [Network settings]** Set the communication channel supported by the application software accordingly.
- [HDMI-CEC control]** Sets for HDMI-CEC function.
- [EDID select]** EDID select settings change how the content displayed is processed and decoded.
- [Position]** Adjusts the position for PC input.
- [No signal power off]** Sets whether or not the display power off when there is no input signal for more than 10 minutes.
- [No activity power off]** Sets whether or not the display power off when there is no operation of the display for more than 4 hours.

- [Button lock]** Limits operation of the buttons on the unit.
- [RC control lock]** Limits operation of the remote control buttons.
- [Front indicator light]** Specifies whether to light the power LED.
- [Auto play]** Sets the type of file to be automatically played from a USB memory device.
- [Information]** Displays the serial number and software version of this unit.
- [All reset]** Resets all the settings to the factory default settings.

Language

Select your preferred language.

Selectable languages

- English
- Français
- Español
- Deutsch

Network settings

Selects the method with which to control the display from the computer.

[Network settings] submenu will be displayed.

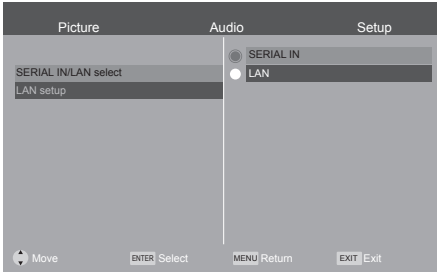

■ [SERIAL IN/LAN select]

RS-232C or LAN function is enable. To control the display via RS-232C, set [SERIAL IN/LAN select] to [SERIAL IN].

Note

- You cannot use RS-232C and LAN control simultaneously.

■ [LAN setup]

Controls via LAN using the LAN terminal.

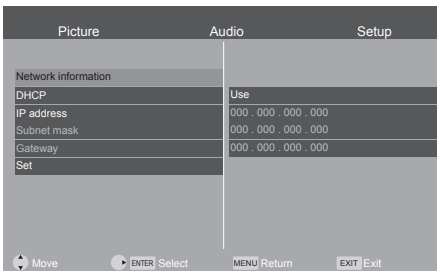
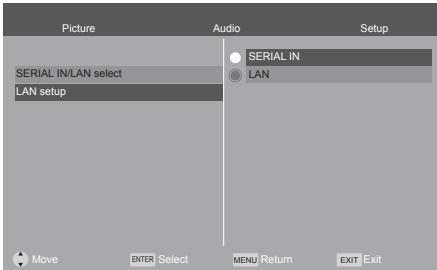

[Network information]

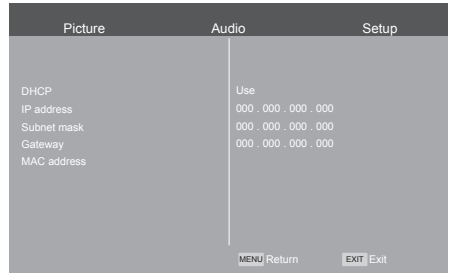

[DHCP], [IP address], [Subnet mask], [Gateway]

① Press <◀▶> to set [Use] / [No Use] of [DHCP].

When [No Use] is selected, IP address and other settings can be set manually.

[DHCP]:

[Use]: Use Dynamic IP address.

[No Use]: Use Static IP address, Subnet mask, and Gateway.

[IP address]:

Enter IP address when [DHCP] is [No Use].

[Subnet mask]:

Enter Subnet mask when [DHCP] is [No Use].

[Gateway]:

Enter Gateway address when [DHCP] is [No Use].

Note

- When [DHCP] is set to [Use], others will be displayed in grey.

Entering numbers

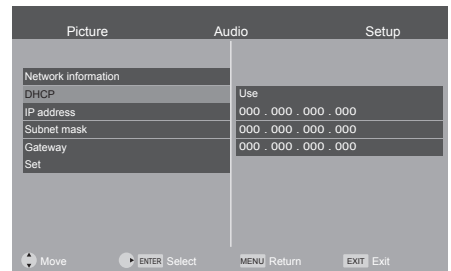

1. Select the address and press <ENTER>.
2. Select digits with the cursor buttons <◀/▶> and <· ·>.
3. Change numbers with the cursor buttons <◀/▶> and the numeric buttons <0 - 9>.
4. Press <ENTER>.

② **Select [Set] and press <ENTER>.**

Save the current network Setup.

Note

- To use a DHCP server, make sure the DHCP server is started.
- Contact your network administrator for details on [IP address], [Subnet mask] and [Gateway].
- Shipping condition [DHCP]: Use

[MAC address]

Displays the MAC address of this unit.

HDMI-CEC control

Set for HDMI-CEC function.

For details of HDMI-CEC function, refer to "Using HDMI-CEC function". (see page 47)

[HDMI-CEC control] - submenu screen

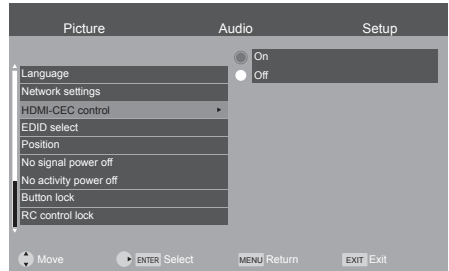

■ **[On]**

When set to [On], the display will automatically switch to the appropriate HDMI input whenever an HDMI connected equipment is initially turned on and the Play mode is selected.

■ **[Off]**

Disables HDMI-CEC control.

Note

- The HDMI CEC feature of connected HDMI CEC-compatible device must be turned on.

EDID select

The menu is displayed in HDMI1 and HDMI2 inputs.

EDID data of each terminal is switched.

[EDID select] - submenu screen

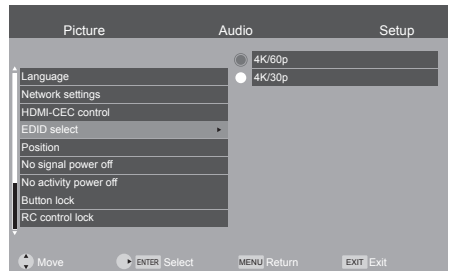

■ **[4K/60p]**

Sets EDID compatible with 4K video signals (Max. 4096 x 2160 dots, Max. vertical operation frequency 60 Hz).

■ **[4K/30p]**

Sets EDID compatible with 4K video signals (Max. 4096 x 2160 dots, Max. vertical operation frequency 30 Hz).

Note

- It is only available for HDMI source.

Position

Adjusts the position.

[Position] - submenu screen

Note

- In some cases, noise appears outside the area picture is displayed, but it is not a malfunction.
- It is only available for PC input.

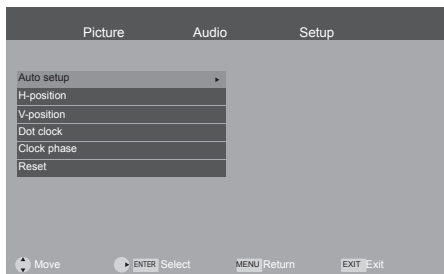
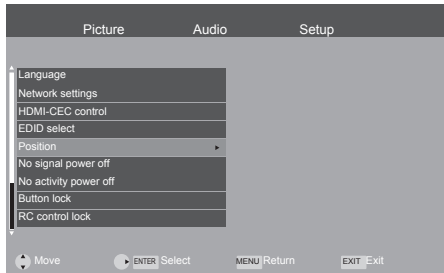

[Auto setup]

Sets the operational mode of the automatic position adjustment.

Note

- [Auto setup] may not work when a cropped or dark image is input. In such case, switch to a bright image with borders and other objects are clearly shown, and then try [Auto setup] again.

[H-position]

Adjusts the horizontal position of the image.

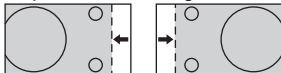

[V-position]

Adjusts the vertical position of the image.

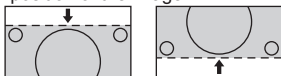

[Dot clock]

Periodic striped pattern interference (noise) may occur when a striped pattern is displayed. If this happens, adjust so that any such noise is minimized.

[Clock phase]

Adjusts sampling clock for applicable video.

Useful when small characters appear with low contrast and/or there are flickers at corners.

When using the adjustment pattern, make adjustments so that no horizontal stripe noise appears in it.

- It should be made only after [Dot clock] has been correctly set.

[Reset]

Resets the values of [Position] items to the factory default settings.

Note

- In some cases, noise appears outside the area picture is displayed, but it is not a malfunction.
- It is only available for PC input.
- In the case that [Auto setup] cannot work well, [Auto setup] may work well to execute [Reset] before [Auto setup].

No signal power off

When this function is set to [Enable], the power is turned off (standby) automatically when there is no signal of the display for 10 minutes.

Starting from 1 minute- before the turn off, the remaining time will be displayed.

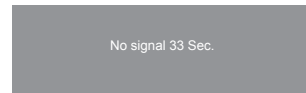

No activity power off

When this function is set to [Enable], the power is turned off (standby) automatically when there is no operation of the Display for 4 hours.

Starting from 1 minute- before the turn off, the remaining time will be displayed.

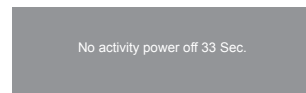

Button lock

Disables the display buttons.

[Button lock] - submenu screen

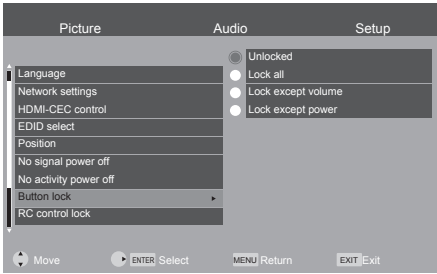

■ [Unlocked] / [Locked]

[Unlocked]: (55/50/43 inch model)

All the buttons on main unit can be used.

[Unlocked]: (86/75/65 inch model)

The button on main unit can be used.

[Locked]: (86/75/65 inch model)

The button on main unit cannot be used.

■ [Lock all]

(only for 55-inch model 50-inch model

43-inch model)

All the buttons on main unit can not be used.

■ [Lock except volume]

(only for 55-inch model 50-inch model

43-inch model)

Disabling all button operations on main unit except <+> and <->.

■ [Lock except power]

(only for 55-inch model 50-inch model

43-inch model)

Disabling all button operations on main unit except <Power button (⏻)>.

Note

- Press <PLAY (▶)> until "L" appears in the screen to disable [Button lock]. Before the "L" disappears, pressing the following sequence cursor buttons <▲▼◀▶>
- You can also disconnect the power cord and then reconnecting the power cord while pressing the <Power button (⏻) (Unit)> on the display.

RC control lock

Disables the remote control buttons.

[RC control lock] - submenu screen

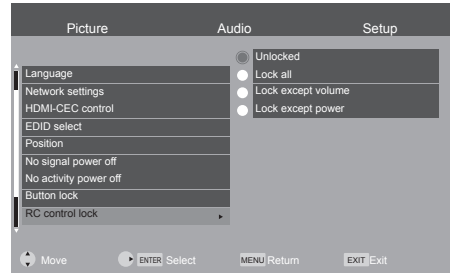

■ [Unlocked]

All the buttons on your remote control can be used.

■ [Lock all]

All the buttons on your remote control can not be used.

■ [Lock except volume]

Disabling all button operations on your remote control except <VOL +> and <VOL ->.

■ [Lock except power]

Disabling all button operations on your remote control except <POWER ON button (|)> / <STANDBY button(⏻)>.

Note

- Press <PLAY (▶)> until "L" appears in the screen to disable [RC control lock]. Before the "L" disappears, pressing the following sequence cursor buttons <▲▼◀▶>
- You can also disconnect the power cord and then reconnecting the power cord while pressing the <Power button (⏻) (Unit)> on the display.

Front indicator light

Enables / Disables the power LED.

[Front indicator light] - submenu screen

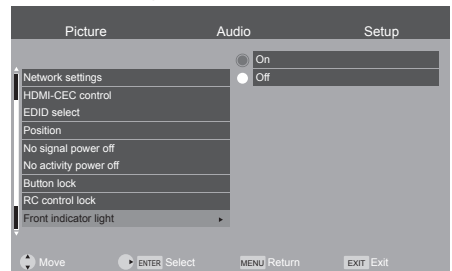

Auto play

Sets the type of file to be automatically played from a USB memory device.

[Auto play] - submenu screen

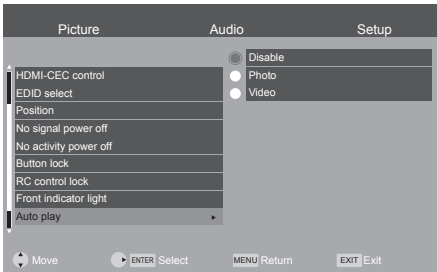

■ [Disable]

Disables the Auto playback function.

■ [Photo]

Photos in a USB memory device can be played automatically. (*.jpg file only)

■ [Video]

Video in a USB memory device can be played automatically. (*.mp4 file only)

Note

- Photos and video cannot be played automatically at the same time. (see page 43)

Information

Displays the display information.

[Information] - submenu screen

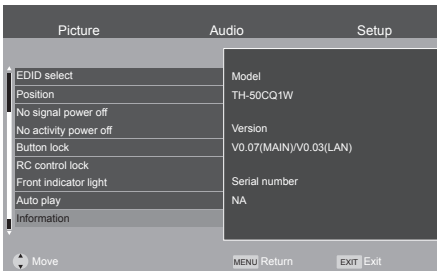

All reset

It is possible to reset the data to the factory settings.

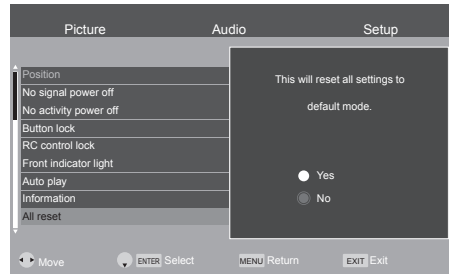

Using Network Function

This unit has a network function and you can control the display connected to the network using your computer.

Necessary environment for computers to be connected

First of all, confirm your computer whether it has a wired LAN.

Before connecting the display to the computer, be sure to check the following settings.

Check 1: About LAN cable

- Connect the cable properly.
- Use LAN cable that is compatible with category 5e or above.

Check 2: Wired LAN settings

Computer with a built-in wired LAN function

- Switch on the wired LAN.

Computer without a built-in wired LAN function

- Check that your wired LAN adapter is recognized properly and it is switched on.
- Install the wired LAN adapter driver beforehand.

For details on how to install the driver, refer to the instructions accompanying the wired LAN adapter.

Example of network connection

Note

- The unit cannot be turned on in standby state since the LAN control is disabled.
- To use the network function, set each item in [Network settings] and make sure to select [LAN]. (see page 35)
- You cannot use RS-232C and LAN control simultaneously.

LAN Terminal connection

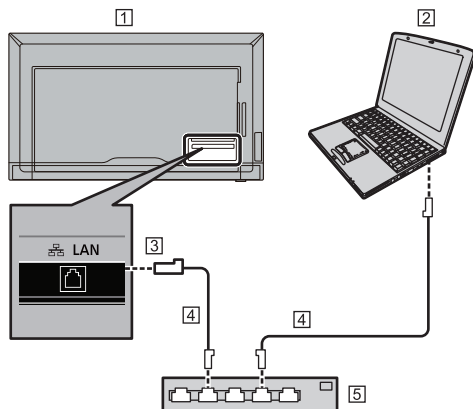

① Display (Back of the unit)

② PC

③ LAN terminal

④ LAN cable (commercially available)

⑤ Hub or broadband router

Note

- For LAN cable, use shielded cable, otherwise picture noise may be caused.
- Make sure the broadband router or hub supports 10BASE-T / 100BASE-TX.
- Touching the LAN Terminal with a statically charged hand (body) may cause damage to the device due to its discharge.
Do not touch the LAN Terminal or the metal part of the LAN cable.
- For instructions on connection, consult your network administrator.

Settings to connect to a LAN

[Important]

The network environment when controlling via LAN is required to be physically isolated from the outside network or not illegally connected / controlled by unknown equipment with the Firewall.

Set the display's IP address and subnet mask to match the settings of your LAN.

These settings can be made on either the display or a computer connected to the display.

The settings depend on the configuration of your LAN. For instructions on connection, consult your network administrator.

To set on the display

Set [SERIAL IN/LAN select] of [Network settings] on the [Setup] menu to [LAN], and then set the [LAN setup] options. (see page 35)

After setting each item, select [Set] and press <ENTER>.

■ Network information

Displays LAN setting information. (see page 35)

Command-based control

You can control the display using serial commands (see page 20) via terminal software and other appropriate applications.

Read the manual for the terminal software for detailed instructions.

Supported commands

Commands used in the serial control are supported. (see page 20)

- Default user name and password are as follows:
User name: dispadmin
Password: @Panasonic

If you change user name and password, please use the command below by serial line.

Command	Parameter	Control details
SSU:UNM	*...*	LAN control user name (Max 16 Parameters) Range of parameters: [space] 0 1 2 3 4 5 6 7 8 9 A B C D E F G H I J K L M N O P Q R S T U V W X Y Z _ a b c d e f g h i j k l m n o p q r s t u v w x y z - @
SSU:UPW	*...*	LAN control password (Max 16 Parameters) Range of parameters: [space] 0 1 2 3 4 5 6 7 8 9 A B C D E F G H I J K L M N O P Q R S T U V W X Y Z _ a b c d e f g h i j k l m n o p q r s t u v w x y z - @

1 Connect the computer to the display.

1. Specify the IP address and data port number (10101) and connect the computer to the display.
When connection has been established successfully, [Login:] is returned as response.
2. Send the user name.
 - Send [user name] + [].
 - If the user name is not set, send [].
 - When the transmission is successful, [Password:] is returned as response.
3. Send the password.
 - Send [password] + [].
 - If the password is not set, send [].
 - When the transmission is successful, [OK] is returned as response.

2 Send commands to control the display.

The commands used are the same as those for RS-232C. Refer to the communication procedure (see page 20) for operation.

Usable commands are provided in the serial command table (see page 20).

3 Disconnect the connection with the display and quit the function.

- Send [BYE]

When the transmission is successful, [goodbye] is returned and the connection is disconnected.

Note

- The display automatically will disconnect one minute after receiving the last data without [BYE] command.
- Repeating the procedure in 1 to 3 every time you send / receive a command or a group of commands is recommended for shortening the time for which the port is open .

Using “USB media file playback function”

It allows you to enjoy photo, music or video recorded on a USB memory device. You can also play Music file during Photo file display.

For information on USB memory device, see page 21.

■ Supported formats

The unit's Media Player supports the formats below. Save immediately below root in USB memory.

Still pictures

Extension	Format	Limitation
jpg/ jpeg	JPEG	Maximum 15 360 x 8 640 (supports baseline only) YUV, RGB

Motion pictures

Extension	Video	Audio	
	Codec/Profile	Resolution	Codec
mp4	H.264/ Main Profile and High Profile @ Level4.0	1920x1080 @ 30.0 Bit rate: Maximum 20Mbps	MP3 (MPEG-1 Layer2, MPEG-1 Layer3, MPEG-2 Layer3) AC3,
ts	MPEG2/ MP @ HL H.264/ Main Profile and High Profile @ Level4.0	1920x1080 @ 30.0 Bit rate: Maximum 20Mbps	LPCM, ADPCM, AAC, DD+ HE-AAC
mpg	MPEG1/ Main Profile MPEG2/ Main Profile	1920x1080 @ 30.0 Bit rate: Maximum 20Mbps	
avi	MPEG2/ MP @ HL H.264 JPEG	1920x1080 @ 30.0 Bit rate: Maximum 20Mbps 640x480 @ 30.0 Bit rate: Maximum 10Mbps	

Music files

Extension	Audio codec
mp3	MP3 (MPEG-1 Layer2, MPEG-1 Layer3, MPEG-2 Layer3)

Audio			
Codec	Sampling rates	Bit Rates	
MP3	MPEG-1 Layer2	16 KHz ~ 48 KHz	8 Kbps ~ 384 Kbps
	MPEG-1 Layer3	16 KHz ~ 48 KHz	8 Kbps ~ 320 Kbps
	MPEG-2 Layer3	16 KHz ~ 48 KHz	8 Kbps ~ 320 Kbps
AC3	32 KHz, 44.1 KHz, 48 KHz	32 Kbps ~ 640 Kbps	
LPCM	8 KHz ~ 48 KHz	64 Kbps ~ 1.5 Mbps	
ADPCM	8 KHz ~ 48 KHz	384 Kbps	
DD+	32 KHz, 44.1 KHz, 48 KHz	32 Kbps ~ 6 Mbps	
AAC	8 KHz ~ 48 KHz		
HE-AAC	8 KHz ~ 48 KHz		

Note

- In some cases it may not be possible to play the above files.
- A maximum of 32 alphanumeric characters can be used for folder name and file name.
- Do not use a file that is over 4 GB.

Play file

Note

- Files are displayed/played according to the order you copy them to a USB memory device. Copy files to a USB memory device according to the order you want to play.
- You can have photo or video files play automatically when a USB memory device is connected or the power is turned on. (see page 43)

■ Select the type of file to be played

1. Insert the USB memory device for Media Player to the USB terminal on the side of the display.

Note

- Depending on the type of a USB memory device, it may come in contact with the periphery such as a back cover, and cannot be attached. Use a USB memory device connectable to this unit.

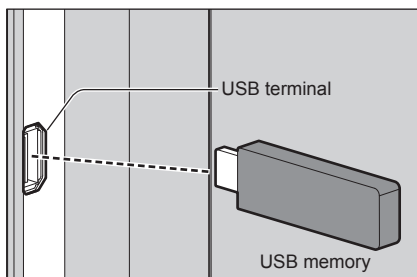

2. Change INPUT to [USB].
3. Select the type of file to be played with the cursor buttons <◀/▶>, and press <ENTER>.

■ Playing files

1. Displays the file to be played.

Select the folder with the cursor buttons <▲▼◀▶> and press <ENTER> to show the files in the folder.

2. Select the file you want to play, and press <ENTER>.

The file is selected.

Multiple files can be selected. You can also select files in different folders.

3. Press <PLAY (▶)>.

The selected files are played.

Note

- The played screen size is [Normal].
- If you press <PLAY (▶)> without selecting a file, all the files in the folder will be played.
- Select [Return] folder to return to the root folder, select [Up folder] folder to return to the next higher folder.
- The volume can be adjusted with the <VOL +> / <VOL -> and <MUTE> on the remote control.
- For operations during play, see page 44.

■ To stop playing

Press <EXIT>.

Auto playback

Photos or video in a USB memory device can be played automatically. (MAX 30 files)

■ Preparations

Prepare the files. Name the file to be played "001-030" such as "001.jpg" - "030.jpg".

1. Creates a folder named "AUTO_PLAYBACK" in the root folder of a USB memory device and copy the files to be automatically played to the folder.

Select the type of file.

1. Press <MENU>, and select [Setup] with the cursor buttons <◀/▶>, select [Auto play] with the cursor buttons <▲/▼> and press <ENTER>.
2. Select the type of file with the cursor buttons <▲/▼> and press <ENTER>.

■ Auto playback of files

Connect a USB memory device (see page 21) and turn on the display power.

Auto play starts.

You can connect a USB memory device (see page 21) after turning on the display power.

Auto play starts.

Note

- Photos and video cannot be played automatically at the same time.
- Auto play repeatedly plays all photo or video files in the "AUTO_PLAYBACK" folder.
- During auto playback, only the button operations of <VOL +> / <VOL -> and <EXIT> are enabled.

■ To stop auto playing

Press <EXIT>.

Operations during play

When playing is started, the operation bar is displayed in the bottom of the screen and you can perform the steps below. If the operation bar is not displayed, press <MENU> to display it.

Item	Description
PLAY/PAUSE	To play the file. To pause the file.
FB	To play fast backward. (Audio and Video only)
FF	To play fast forward. (Audio and Video only)
Previous	To go to previous file.
Next	To go to next file.
STOP	To stop the playing file.
Item	Description
Repeat none	Repeat none -
Repeat 1	After starting playing the files selected in the menu, each file in the same folder is played once in order until the last one.
Repeat all	Also, if you start playing several files checked in the menu, they are played once. Repeat 1 - The one file selected or checked in the menu is repeatedly played. Repeat all - To play and repeat files in the playlist.
Set A	Set the interval to play and repeat.
Set B	Set A -
None	Set the start point of the interval. Set B - Set the end point of the interval. (Audio and Video only)
Random On	Random On -
Random Off	To play and repeat all files in random. Random Off - To play and repeat all files in order.
Music On	When selected [Music On], the photo and music files in the same folder are synchronized.
Music Off	(Photo only)
Interval	To select the slideshow time. (Photo only)
Playlist	To show the playlist.
Info.	To show the file information.
Rotate (Clockwise)	To rotate the file 90 degrees clockwise. (Photo only)
Rotate (Counter-Clockwise)	To rotate the file 90 degrees Anti-clockwise. (Photo only)

Zoom in	To zoom in the file. (Photo only)
Zoom out	To zoom to the file. (Photo only)
Move	To select view area in zoomed viewing. (Photo only)
Dynamic Graphic Sports Cinema Standard	To select the video settings. (Video only)

Playing the pictures

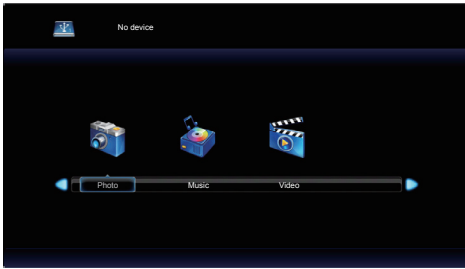

Select a file in the same manner in the file list view.

1 Press <▲▼◀▶> to select the file you want to play.

[▶] : To play the selected file

[ENTER] : Selected the file.

[EXIT] : To return the media type select page.



2 Press <ENTER>

The picture will be displayed on the full screen.



1. Operation bar

Press <MENU> to display operation bar on the bottom of screen

Then press the cursor buttons <◀/▶> to perform the following operations.

[PLAY/PAUSE] To play the image slideshow.
To pause the playing image.

[Previous] To go to previous image.

[Next] To go to next image.

[STOP] To stop the playing image slideshow.

[Repeat all]

Repeat all -

[Repeat none]

All the files in the same folder are repeatedly played.

[Repeat 1]

Repeat none -

After starting playing the files selected in the menu, each file in the same folder is played once in order until the last one.

Repeat 1 -

The one file selected or checked in the menu is repeatedly played.

[Random On]

Select to play images in the folder randomly.

[Random Off]

[Music Off]

Setting to [Music On], the photo and music files in the same folder are played at the same time.

[Music On]

[Interval]

Select Slideshow time.

[Playlist]

Show Playlist.

[Info.]

Show the file information.

[Rotate]

(Clockwise)

Rotate the image 90 degrees clockwise temporarily.

[Rotate]

(Counter-Clockwise)

Rotate the image 90 degrees Anti-clockwise temporarily.

[Zoom in]

To zoom-in the image.

[Zoom out]

To zoom-out the image.

[Move]

Select view area in zoomed.

2. Information window

Press <DISPLAY> to show the information window

Playing the music / video



1 Select the file you want to play in the same manner as “Playing the pictures”. (see page 45)

- : To play the selected file
- : Selected the file.
- : To return the media type select page.

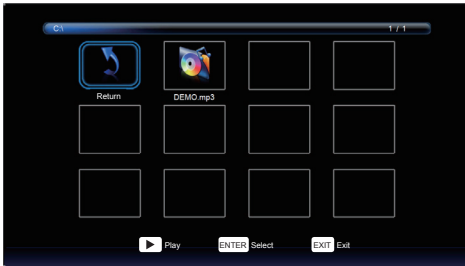

2 Press <ENTER>

The video will be displayed on the full screen.

Note

- The music icon is displayed on the screen for music playback.



1. Operation bar

Press <MENU> to display operation bar on the bottom of screen

Then press the cursor buttons <◀/▶> to perform the following operations.

- [PLAY/PAUSE] To play the music / video.
To pause the playing image.

- [FB] To play the file fast backward.
FB2X / FB4X / FB8X / FB16X
- [FF] To play the file fast forward.
FF2X / FF4X / FF8X / FF16X
- [Previous] To go to previous the file. When playing video, press once to play from the beginning.
- [Next] To go to next file.
- [STOP] To stop the playing file.
- [Repeat all] Repeat all -
- [Repeat none] All the files in the same folder are repeatedly played.
- [Repeat 1] Repeat none -
After starting playing the files selected in the menu, each file in the same folder is played once in order until the last one.
Repeat 1 -
The one file selected or checked in the menu is repeatedly played.
- [Random On] Select to play images in the folder randomly.
- [Random Off]
- [Set A] Set A -
- [Set B] Set the interval of the start point.
- [None] Set B - Set the interval of the end point.
- [Playlist] Show Playlist.
- [Info.] Show the file information.
- [Dynamic] Select video settings.
- [Graphic] (Video only)
- [Sports]
- [Cinema]
- [Standard]

You can also adjust the file by using the navigation keys <◀◀, ||, ▶, ▶▶> and the cursor buttons <◀/▶> on the remote control. (see page 44)

2. Information window

Press <DISPLAY> to show the information window

Using HDMI-CEC function

The HDMI-CEC function enables the remote control of this unit alone to operate the basics of HDMI-CEC compatible devices by the interlocking control between this unit and such devices. Also, this function enables the remote control (or main unit's buttons) of a HDMI-CEC compatible device alone to turn on/off this unit and switch input.

Connection

Connect the HDMI-CEC compatible device to HDMI 1 or HDMI 2 terminal.

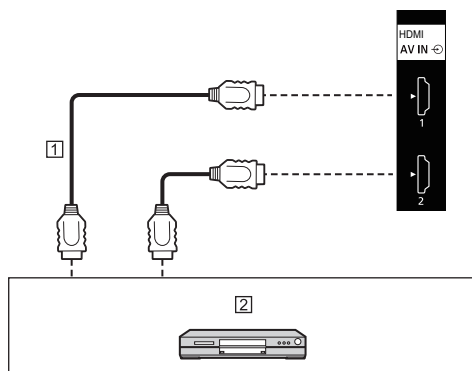

① HDMI cable (commercially available)

② DVD Recorder / DVD Player, Blu-ray Recorder / Blu-ray Player

Setting

- ① Make the setting on the connected device (HDMI-CEC compatible device) so this function can operate.
- ② Set [HDMI-CEC control] to [On]. (see page 36)
- ③ Turn on all the devices, and turn this unit off and on. Then check if images can be seen correctly with HDMI1 or HDMI2 input.

Preset Signals

This unit can display the video signals shown in the table below.

- The contents of HDMI signal in the Plug and Play-supported signal column are as follows.

1: 4K/60p, 2: 4K/30p

Corresponding signal	Resolution (Dot)	Scanning frequency		Dot clock frequency (MHz)	Format*2	Plug and Play-supported signal*4		
		Horizontal (kHz)	Vertical (Hz)			HDMI		PC
						1	2	
480/60i	720 (1 440) x 480i*1	15.73	59.94	27.00	H	○	○	—
576/50i	720 (1 440) x 576i*1	15.63	50.00	27.00	H	○	○	—
480/60p	720 x 480	31.47	59.94	27.00	H	○	○	—
576/50p	720 x 576	31.25	50.00	27.00	H	○	○	—
720/60p	1 280 x 720	45.00	60.00	74.25	H	○	○	—
720/50p	1 280 x 720	37.50	50.00	74.25	H	○	○	—
1080/60i	1 920 x 1 080i	33.75	60.00	74.25	H	○	○	—
1080/50i	1 920 x 1 080i	28.13	50.00	74.25	H	○	○	—
1080/24p	1 920 x 1 080	27.00	24.00	74.25	H	○	○	—
1080/25p	1 920 x 1 080	28.13	25.00	74.25	H	○	○	—
1080/30p	1 920 x 1 080	33.75	30.00	74.25	H	○	○	—
1080/60p	1 920 x 1 080	67.50	60.00	148.50	H	○	○	—
1080/50p	1 920 x 1 080	56.25	50.00	148.50	H	○	○	—
3840 x 2160/24p	3 840 x 2 160	54.00	24.00	297.00	H	○	○	—
3840 x 2160/25p	3 840 x 2 160	56.25	25.00	297.00	H	○	○	—
3840 x 2160/30p	3 840 x 2 160	67.50	30.00	297.00	H	○	○	—
3840 x 2160/60p	3 840 x 2 160	135.00	60.00	594.00	H	○	—	—
3840 x 2160/50p	3 840 x 2 160	112.50	50.00	594.00	H	○	—	—
4096 x 2160/24p	4 096 x 2 160	54.00	24.00	297.00	H	○	○	—
4096 x 2160/25p	4 096 x 2 160	56.25	25.00	297.00	H	○	○	—
4096 x 2160/30p	4 096 x 2 160	67.50	30.00	297.00	H	○	○	—
4096 x 2160/60p	4 096 x 2 160	135.00	60.00	594.00	H	○	—	—
4096 x 2160/50p	4 096 x 2 160	112.50	50.00	594.00	H	○	—	—
640 x 480/60	640 x 480	31.47	59.94	25.18	R/H	○	○	○
800 x 600/60	800 x 600	37.88	60.32	40.00	R/H	○	○	○
1024 x 768/60	1 024 x 768	48.36	60.00	65.00	R/H	○	○	○
1280 x 720/60	1 280 x 720	45.00	60.00	74.25	R/H	○	○	○
1280 x 800/60	1 280 x 800	49.70	59.81	83.50	R/H	○	○	○
1280 x 960/60	1 280 x 960	60.00	60.00	108.00	R/H	○	○	○
1280 x 1024/60	1 280 x 1 024	63.98	60.02	108.00	R/H	○	○	○
1280 x 1024/75	1 280 x 1 024	79.98	75.02	135.00	R/H	○	○	○
1360 x 768/60	1 360 x 768	47.71	60.02	85.50	H	—	○	—
1400 x 1050/60	1 400 x 1 050	65.32	59.98	121.75	H	○	○	—
1440 x 900/60	1 440 x 900	55.94	59.89	106.50	R/H	○	○	○
1600 x 900/60	1 600 x 900*3	60.00	60.00	108.00	R/H	○	○	○
1600 x 1200/60	1 600 x 1 200	75.00	60.00	162.00	R/H	○	○	○
1680 x 1050/60	1 680 x 1 050	65.29	59.95	146.25	R/H	○	○	○
1920 x 1080/60	1 920 x 1 080	67.50	60.00	148.50	R/H	○	○	○
1920 x 1200/60	1 920 x 1 200*3	74.04	59.95	154.00	R/H	○	○	○
720 x 400/70	720 x 400	31.50	70.00	28.30	R/H	○	○	○

*1: Pixel-Repetition signal (dot clock frequency 27.0 MHz) only

*2: Signals to represent formats are as follows.

R: D-sub RGB (PC IN)

H: HDMI (HDMI 1, HDMI 2)

*3: Based on VESA CVT-RB (Reduced Blanking) standard

*4: Signals with ◦ in the Plug and Play-supported signal column are the ones written in EDID (Extended Display Identification Data) of this unit.











For signals without ◦ in the Plug and Play-supported signal column, resolutions may not be selected on the PC side even if this unit supports those signals.

Note

- An auto detected signal format may be differently displayed from the actual input signal.
- [i] shown after the number of dots of resolution means the interlace signal.

Troubleshooting

Before you call for service, determine the symptoms and make a few simple checks as shown below.

Symptoms		Check
Picture	Sound	
 Interference	 Noisy Sound	Electrical Appliances Cars / Motorcycles Fluorescent light
 Normal Picture	 No Sound	Volume (Check whether the mute function has been activated on the remote control.) Make sure the volume is not set to minimum.
 No Picture	 No Sound	Not plugged into AC outlet Not switched on Picture and Brightness/Volume setting (Check by pressing the POWER ON () button or STANDBY (⏻) button.)
 No Picture	 Normal Sound	If a signal with a non-applicable colour system format, or frequency is input, only the input terminal indication is displayed.
 No Colour	 Normal Sound	Colour controls set at minimum level (see page 31)
A display error such as "no picture" occurs, or remote control operation is suddenly disabled.		Load noises from outside may be interfering with normal operation. Turn off the power and turn it on after waiting at least 5 seconds, and then check the operation.
The screen turns off automatically.		Check the settings of [No signal power off] may be set to [Enable]. (see page 37)
No remote control operations can be performed.		Are the batteries inserted with polarity (+,-) aligned? (see page 12) Are the batteries exhausted? Point the remote control unit toward the display's remote control sensor. (see page 23) Check whether the option other than [Unlocked] is selected in [RC control lock]. (see page 38)
Unstable video		The signal may be incompatible. Try the automatic screen adjustment when PC is in use.
There are areas at the top and bottom of the screen where picture is not displayed.		When using a video software program (such as a cinema size program) with a screen wider than one in the 16:9 mode, blank areas separate from the images are formed at the top and bottom of the screen.
Parts of the unit become hot.		Even when the temperature of parts of the front, top and rear panels has risen, these temperature rises will not pose any problems in terms of performance or quality.
The video from the HDMI input terminal is abnormal.		Check the HDMI cable support 4K, and whether compliant of HDMI standard. Check the input signal compatible with this display. (see page 48 - 49) To set [EDID select] to [4K/30p] when the connected device does not support 4K.
The video from D-Sub input terminal is abnormal.		Check the PC setting correct. Check the input signal compatible with this display. (see page 48 - 49)

Symptoms	Check
The Serial commands is uncontrollable.	Check that [SERIAL IN/LAN select] is selected [SERIAL IN]. (see page 35) Check whether the connection has been made properly. (see page 19)
The LAN is uncontrollable.	Check that [SERIAL IN/LAN select] is selected [LAN]. (see page 35) Check that the connection has been made properly. (see page 40) Check that [LAN setup] is set properly. (see page 35)
The unit is not turned on even if the power ON command is sent with the LAN control.	The unit is designed so that it cannot be turned on with the LAN control in standby state. When controlling the power on/off in remote operation, use the serial control.

LCD Display panel

Symptoms	Check
It takes a while for the picture to appear.	The unit digitally processes the various signals in order to reproduce esthetically pleasing images. As such, it sometimes takes a few moments for the picture to appear when the power has been turned on, when the input has been switched.
The edges of the images flicker.	Due to the characteristics of the system used to drive the liquid crystal panel, the edges may appear to flicker in the fast-moving parts of the images: This is normal and not indicative of malfunctioning.
There may be always-lighting dots or non-lighting dots appear on the screen.	This is a characteristic of liquid crystal panels and is not a problem.
 <p>Image retention appears</p>	Image retention may occur. If you display a still picture for an extended period, the image might remain on the screen. However, it will disappear when a general moving picture is displayed for a while. This is not considered as malfunction.

This display uses special image processing. Hence a slight time lag may occur between image and audio, depending on the type of input signal. However, this is not a malfunction.

Specifications

Model No.

86-inch model : TH-86CQ1W

75-inch model : TH-75CQ1W

65-inch model : TH-65CQ1W

55-inch model : TH-55CQ1W

50-inch model : TH-50CQ1W

43-inch model : TH-43CQ1W

Power Consumption

86-inch model

330 W

75-inch model

266 W

65-inch model

133 W

55-inch model

125 W

50-inch model

116 W

43-inch model

102 W

Stand-by condition

0.5 W

LCD Display panel

86-inch model

86-inch IPS panel (Edge LED backlight), 16:9 aspect ratio

75-inch model

75-inch IPS panel (Direct LED backlight), 16:9 aspect ratio

65-inch model

65-inch VA panel (Direct LED backlight), 16:9 aspect ratio

55-inch model

55-inch VA panel (Direct LED backlight), 16:9 aspect ratio

50-inch model

50-inch VA panel (Direct LED backlight), 16:9 aspect ratio

43-inch model

43-inch VA panel (Direct LED backlight), 16:9 aspect ratio

Screen size

86-inch model

1 895.0 mm (W) × 1 065.9 mm (H) × 2 174.2 mm (diagonal) / 74.60" (W) × 41.96" (H) × 85.60" (diagonal)

75-inch model

1 649.6 mm (W) × 927.9 mm (H) × 1 892.7 mm (diagonal) / 64.94" (W) × 36.53" (H) × 74.51" (diagonal)

65-inch model

1 428.4 mm (W) × 803.5 mm (H) × 1 638.9 mm (diagonal) / 56.23" (W) × 31.63" (H) × 64.52" (diagonal)

55-inch model

1 209.6 mm (W) × 680.4 mm (H) × 1 387.8 mm (diagonal) / 47.62" (W) × 26.78" (H) × 54.63" (diagonal)

50-inch model

1 095.8 mm (W) × 616.4 mm (H) × 1 257.3 mm (diagonal) / 43.14" (W) × 24.26" (H) × 49.50" (diagonal)

43-inch model

941.1 mm (W) × 529.4 mm (H) × 1 079.8 mm (diagonal) / 37.05" (W) × 20.84" (H) × 42.51" (diagonal)

No. of pixels

8 294 400

(3 840 (Horizontal) × 2 160 (Vertical))

Dimensions (W × H × D)

86-inch model

1 929 mm × 1 103 mm (excluding Remote Control Sensor: 1 100 mm) × 80 mm / 75.92" × 43.41" (excluding Remote Control Sensor: 43.28") × 3.13"

75-inch model

1 684 mm × 969 mm (excluding Remote Control Sensor: 966 mm) × 94 mm / 66.30" × 38.14" (excluding Remote Control Sensor: 38.01") × 3.70"

65-inch model

1 463 mm × 847 mm (excluding Remote Control Sensor: 843 mm) × 97 mm / 57.57" × 33.32" (excluding Remote Control Sensor: 33.17") × 3.81"

55-inch model

1 240 mm × 718 mm (excluding Remote Control Sensor: 713 mm) × 80 mm / 48.79" × 28.25" (excluding Remote Control Sensor: 28.05") × 3.12"

50-inch model

1 124 mm × 653 mm (excluding Remote Control Sensor: 647 mm) × 77 mm / 44.24" × 25.70" (excluding Remote Control Sensor: 25.47") × 3.04"

43-inch model

969 mm × 566 mm (excluding Remote Control Sensor: 560 mm) × 77 mm / 38.12" × 22.26" (excluding Remote Control Sensor: 22.03") × 3.03"

Mass

86-inch model

Approx. 50.0 kg / 111 lbs net

75-inch model

Approx. 34.0 kg / 75 lbs net

65-inch model

Approx. 24.0 kg / 53 lbs net

55-inch model

Approx. 15.0 kg / 34 lbs net

50-inch model

Approx. 13.0 kg / 29 lbs net

43-inch model

Approx. 9.0 kg / 20 lbs net

Power source

220 – 240 V ~ (220 – 240 V alternating current),
50/60 Hz

Operating condition

Temperature

0 °C – 40 °C (32 °F – 104 °F)*1

Humidity

20 % – 80 % (no condensation)

Storing condition

Temperature

-20 °C – 60 °C (-4 °F – 140 °F)

Humidity

20 % – 80 % (no condensation)

Operating Time

16 hours/day

Connection terminals

HDMI 1

HDMI 2

TYPE A Connector*2 × 2

Audio signal:

Linear PCM (sampling frequencies: 48 kHz,
44.1 kHz, 32 kHz)

AUDIO IN

Stereo mini jack (M3) × 1, 0.5 Vrms

PC IN

Mini D-sub 15 Pin (Compatible with DDC2B) × 1

AUDIO OUT

RCA jack, 0.5 Vrms

Output: Variable (-∞ – 0 dB)

(1 kHz 0 dB input, 10 kΩ load)

SERIAL IN

External Control Terminal

D-sub 9 Pin × 1:

RS-232C compatible

LAN

Communication method:

RJ45, 10BASE-T / 100BASE-TX

USB

USB connector × 1, TYPE A

DC 5 V / 0.5 A

Sound

Speakers

132 mm × 25 mm × 1 / φ 70 mm × 1 × 2 pieces

Audio Output

20 W [10 W + 10 W] (10 % THD)

Remote Control Transmitter

Power source

DC 3 V (battery (R03/LR03 type) × 2)

Operating range

Approx. 7 m (22.9 ft)

(when operated directly in front of remote control sensor)

Mass

Approx. 91 g / 3.21 oz (including batteries)

Dimensions (W × H × D)

48 mm × 190 mm × 27 mm / 1.89" × 7.48" × 1.06"

*1: Environmental temperature to use this unit at high altitudes (1 400 m (4 593 ft) and higher and below 2 800 m (9 186 ft) above sea level): 0 °C to 35 °C (32 °F to 95 °F)

*2: VIERA LINK is not supported.

Note

- Design and specifications are subject to change without notice. Mass and dimensions shown are approximate.

Disposal of Old Equipment and Batteries

Only for European Union and countries with recycling systems



These symbols on the products, packaging, and/or accompanying documents mean that used electrical and electronic products and batteries must not be mixed with general household waste. For proper treatment, recovery and recycling of old products and used batteries, please take them to applicable collection points in accordance with your national legislation.

By disposing of them correctly, you will help to save valuable resources and prevent any potential negative effects on human health and the environment.

For more information about collection and recycling, please contact your local municipality. Penalties may be applicable for incorrect disposal of this waste, in accordance with national legislation.

EU



Note for the battery symbol (bottom symbol)

This symbol might be used in combination with a chemical symbol. In this case it complies with the requirement set by the Directive for the chemical involved.

Information on Disposal in other Countries outside the European Union

These symbols are only valid in the European Union.

If you wish to discard these items, please contact your local authorities or dealer and ask for the correct method of disposal.

Customer's Record

The model number and serial number of this product may be found on its rear panel. You should note this serial number in the space provided below and retain this book, plus your purchase receipt, as a permanent record of your purchase to aid in identification in the event of theft or loss, and for Warranty Service purposes.

Model Number

Serial Number

Panasonic Testing Centre

Panasonic Service Europe, a division of Panasonic Marketing Europe GmbH

Winsbergring 15, 22525 Hamburg, F.R. Germany

Panasonic Corporation

English

Web Site: <https://panasonic.net/cns/prodisplays/>