

Panasonic[®]

Operating Instructions Basic Guide

Wireless Presentation System Receiver Board

For business use

PressIT

* PressIT is a nickname for "Wireless Presentation System".

Thank you for purchasing the Panasonic product.

- Please read these instructions before operating this product and retain them for future reference.
- **Be sure to read "Safety Precautions" (page 2) before use.**

English

DA0121TS1042 -PB

Model No. **TY-SB01WP**

Safety Precautions	2
Precautions for use	3
Part Names	4
Installation of the receiver board	5
Basic Use	6
Transmitter Extension Method (Pairing)	8
Setting	10
Notes on Using Wireless LAN	15
Request Regarding Security	17
Specifications	19

DPQX1531ZB/X1

Safety Precautions

WARNING:

When mounting or removing this product on or from the flat panel display unit, be sure to turn the power off, and remove the power plug from the socket.

Otherwise, electric shock may occur.

Never attempt to disassemble or modify this product.

Doing so may cause fire, electric shock or operation errors.

If you sense smoke, unpleasant odour or unusual noises, immediately disconnect the power plug from the socket.

Using the product in an abnormal condition may cause fire or electric shock.

For mounting or removing this product on or from the flat panel display unit, ask a qualified technician or sales dealer.

Installing the product improperly may cause a malfunction or electric shock.

- If you terminate the use of the product, ask a professional to remove it promptly.

Use the product 15 cm or more away from a location where a cardiac pacemaker is embedded.

Radio waves may affect the operation of the pacemaker.

Do not use the product in an airplane.

The operational safety may be impaired.

Do not use the product near an automatic door, fire alarm or other automatic control devices.

Radio waves from this product may affect automatic control devices, which may cause an operational error, resulting in an accident.

Do not use the product in hospital or a location with medical equipment.

Radio waves from this product may affect medical equipment, which may cause an operational error, resulting in an accident.

Do not wet the product.

Doing so may cause a fire or electric shock.

CAUTION:

Do not place the product at a high-temperature location, humid or dusty location, or location subject to oil smoke or steam (such as a cooking table and humidifier).

Doing so may cause a fire or electric shock.

Do not place the product in locations subject to direct sunlight or extremely high temperature.

- The internal parts may be damaged, or fire may occur.

Precautions for use

This product is a Wireless Presentation System Receiver Board used by being attached to a Panasonic display.

Do not touch this product directly by hand.

- Static electricity may occur, destroying the components. Static electricity is also generated from clothing or human body. Let the static electricity escape by touching metallic objects such as a steel cabinet beforehand.

The illustrations and figures in this manual are for explanatory purposes and may differ from the actual product.

Details of usage

For details of usage, read "Operating Instructions - Functional Manual".

Download the "Operating Instructions - Functional Manual" from the following URL.

<https://panasonic.net/cns/prodisplays/wps2/>

For detailed usage of a display supporting this product, read the operating instructions of the display.

Part Names

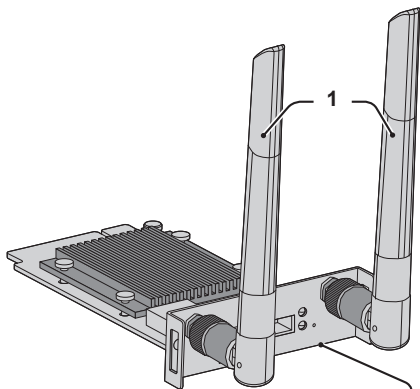

▼ Connection terminals / Controls

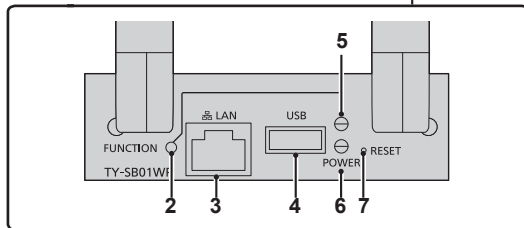

1 Antenna

▼ Connection terminals / Controls

2 FUNCTION button

Used to save a pairing file to the USB memory.

3 LAN terminal (RJ45)

Connects to the network to change the settings of the product.

4 USB terminal (Type-A)

Connects the transmitter or USB memory when pairing devices.
Use this by connecting an HID device (mouse, touch module).

5 FUNCTION LED

Displays the pairing status.

6 Power Indicator

Displays the power supply status, and connection statuses of LAN and USB.

7 Reset button

Restores the product to the factory default state.
Reset operation starts when the reset button is pressed for 5 seconds or more.

Installation of the receiver board

The installation instruction below is based on the flat panel display SQ1 series as an example.

For attaching or removing this product to or from the flat panel display unit, it is recommended to ask a qualified technician or sales dealer. A malfunction may occur due to static electricity, etc. Consult the sales dealer.

Follow the steps below.

Note

- Be sure to turn off the display unit and connected devices, remove the power plug from the socket, and disconnect the cables from the display.
- When attaching/removing the receiver board, do not allow the metal to damage the back cover or display label.

1 Remove the 2 screws, and then remove the slot cover or receiver board from the display unit.

To remove the receiver board, hold the handle of the receiver board and pull it out slowly in the arrow direction.

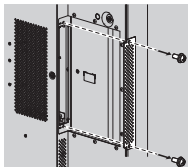

2 Insert the receiver board to the main unit slot, and tighten the 2 screws.

Fix the receiver board with the 2 screws removed in step 1.

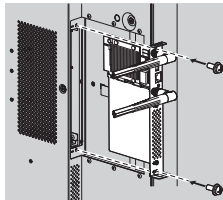

- Tightening torque guideline: 0.5 N·m or less

Note

- When replacing another receiver board with this product, the customer shall keep the replaced receiver board for future repair or servicing.

Basic Use

Receiver board

- 1 Turn on the display.
- 2 Switch the input of the display to [SLOT].
- 3 Pair the receiver board and the transmitter.
(when connecting for the first time, see page 8)
- 4 When the standby screen appears on the display, preparation of the receiver board is complete.



Standby screen

Transmitter

- 1 Connect the USB terminal and HDMI input terminal of the transmitter to the image output device.
 - For power supply to the transmitter, 5 V/0.9 A power supply is necessary.

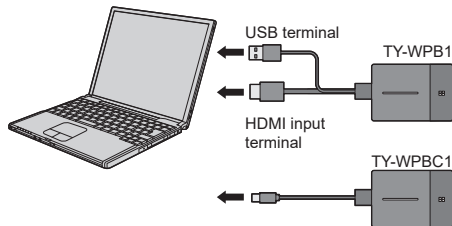

For TY-WPBC1, connect the USB terminal (Type-C) to an image output device that supports the DisplayPort ALT Mode.

2 Main LED changes from red blinking (connecting) to white illumination (standby).

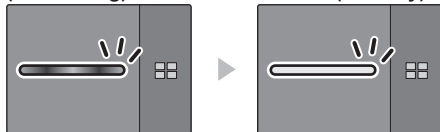

Red blinking (connecting)

White illumination
(standby)

3 Press the main button of the transmitter.

The image is displayed.



Standby screen

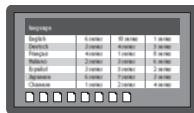

Full screen display

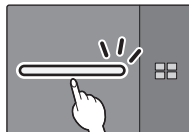

White illumination
(standby)

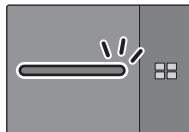

Green illumination
(display)

▶ Pressing the main button again changes the main LED to white and returns to standby state.

(The screen returns to the standby screen as well.)

- When using multiple transmitters, the image is switched to the image of the transmitter of which the main button is pressed.

Transmitter Extension Method (Pairing)

Pairing by connecting the receiver board and transmitter

- 1 Slide the mode switch to the STD side.



- 2 Connect the USB terminal of the transmitter to the USB terminal of the receiver board.

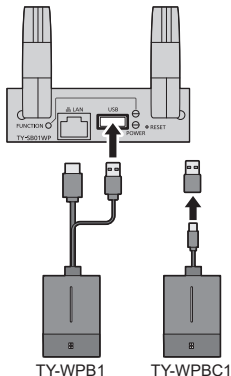

Wait for a while until the FUNCTION LED of the receiver board blinks in white. Then, pairing starts automatically.

"Pairing..." (pairing in progress) is displayed on the standby screen.

- 3 Pairing is complete.

"Pairing OK" is displayed and the FUNCTION LED of the receiver board lights up in white.



- 4 Remove the USB cable of the transmitter from the receiver board.

Pairing by saving a file to the USB memory

Supported device

- Commercially available USB memory devices are supported. (Those with security functions are not supported.)
- USB memory devices other than those formatted in FAT16 or FAT32 cannot be used.
- Up to 32 GB of USB memory in size are supported.
- Only single partition configuration is supported.

1 Connect the USB memory to the USB terminal of the receiver board.

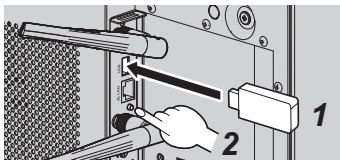

2 Press the FUNCTION button.

The FUNCTION LED lights up in white and the pairing file is saved to the USB memory.

3 Remove the USB memory.

4 Slide the mode switch to the EXT side.

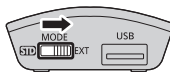

5 Supply power to the transmitter.

TY-WPB1

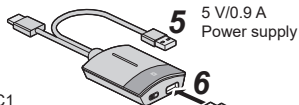

TY-WPBC1

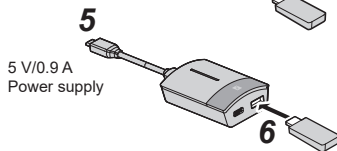

6 Connect the USB memory to the USB terminal of the transmitter.

7 Pairing is complete.

The main LED of the transmitter lights up in white.

8 Remove the USB memory from the transmitter.

Setting

[Setup] menu (display setting)

When this product is connected to the compatible display and the [Setup] menu is set, the following functions can be used.

This section explains each setting using the display SQ1 series as an example. For settings on other models, see the Panasonic information site.

Panasonic display link function

Just connect the receiver board to a Panasonic display supporting this product and turn them on to perform the link operation. (It is necessary to set [Wireless presentation link] to [On].)

Set link function details in the following setting menus.

External device link settings

Sets external device link.

[External device link settings]- submenu screen

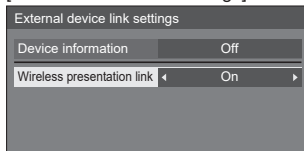

● [Device information]

Sets whether to display or hide the information of the device connected to the HDMI terminal and SLOT.

[Off]: Connected device information is not displayed.

[On]: Connected device information is displayed as shown below.

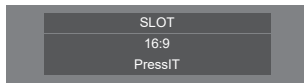

Note

- The obtained information of either signal or HDMI-CEC is displayed.
- Up to the first 16 characters obtained are displayed.

● [Wireless presentation link]

Sets the link of the Display with this product.

[Off]: Does not link with this product.

[On]: Links with this product.

Note

- When this receiver board is connected to the SLOT, the link function works.
- The following functions are fixed.
These settings are held even if this function is switched from [On] to [Off]. The settings can be changed on each setting menu.
 - [Picture mode] is fixed to [Graphic].
 - [HDMI-CEC control] is fixed to [Enable]. [Display → Device] is fixed to [Power off / on]. [Device → Display] is fixed to [Power off / on].
- Even if this function is set to [Off], the HDMI-CEC function works.

■ [Wireless presentation settings]

Note

- Approx. 5 seconds may be required to reflect the menu settings.

[Wireless presentation settings] - sub menu screen

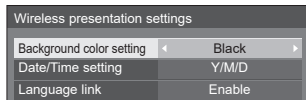

● [Background color setting]

[Black]: The background color for the standby screen and no-signal image is set to black.

[Blue]: The background color for the standby screen and no-signal image is set to blue.

Note

- When the image is changed with the [My Screen] function on the Web setting screen, this setting is not reflected.

● [Date/Time setting]

Specifies the display style of date on the standby screen.

[Y-M-D]: e.g. 2021-08-24

[Y/M/D]: e.g. 2021/08/24

[Y.M.D]: e.g. 2021.08.24

[D-M-Y]: e.g. 24-08-2021

[D/M/Y]: e.g. 24/08/2021

[D.M.Y]: e.g. 24.08.2021

[M-D-Y]: e.g. 08-24-2021

[M/D/Y]: e.g. 08/24/2021

[M.D.Y]: e.g. 08.24.2021

[M D,Y]: e.g. 08 24,2021

[Off]: Date is not displayed on the standby screen.

Note

- When this is set to [Off], the setting is applied at the next startup of this system.
- There is the same menu on the Web setting screen as this menu item. Since the setting on the display is prioritized, when the system is started next time, the setting value on the display is reflected.

● [Language link]

[Enable]: Sets the language for the standby screen, no-signal image and Web setting screen to the language set for [OSD language].

[Disable]: Sets the language for the standby screen, no-signal image and Web setting screen to the language set for [Language] on the Web setting screen.

■ HDMI-CEC settings

Set for HDMI-CEC function.

[HDMI-CEC settings] - submenu screen

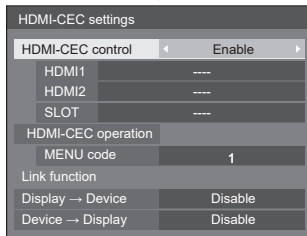

- **[HDMI-CEC control]**

Enables/Disables the HDMI-CEC function.

[Disable]: Disables HDMI-CEC control.

[Enable]: Enables HDMI-CEC control.

Note

- Enables/Disables the Display to perform interlocking control of the HDMI-CEC compatible device.

- **[SLOT]**

[PressIT] is displayed.

- **[MENU code]**

No code is assigned to this system.

- **[Display → Device]**

Enables/Disables the Display to perform interlocking control of the HDMI-CEC compatible device.

[Disable]: Disables the Display to perform interlocking control of the HDMI-CEC compatible device.

Even if the power status of the Display changes, the power status of the device will not be affected.

[Power off]: Turning the Display off (standby) turns off (standby) all the devices connected to the HDMI 1, HDMI 2 or SLOT terminal. The power-on operation is not interlocked.

[Power off / on]: The device turns off/on (standby) in conjunction with the power-off/on (standby) operation of the Display.

- **[Device → Display]**

Enables/Disables the HDMI-CEC compatible device to perform interlocking control of the Display.

[Disable]: Disables the device to perform interlocking control of the Display. Even if the power status of the device changes, the power status of the Display will not be affected.

[Power on]: Turning on the device turns on the Display, and the input (HDMI1 / HDMI2 / SLOT) is switched to that of the device.

[Power off / on]: The power status of the Display interlocks with the power-off/on operation of the device.

■ SLOT settings

Set for SLOT.

[SLOT settings] - submenu screen

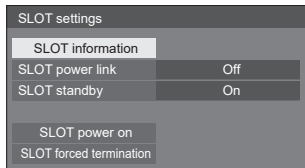

● [SLOT standby]

Sets the power supply status for the SLOT when the unit is in standby mode.

[Off]: The power is not supplied to the SLOT when the power is turned off by the remote control, etc.

[On]: The power is supplied to the SLOT when the power is turned off by the remote control, etc.

Note

- When [SLOT standby] is set to [On], the power indicator in standby mode lights orange (red/green).
- When [HDMI-CEC control] is set to [Enable], this menu will be greyed out and cannot be set. (see page 13)

Notes on Using Wireless LAN

Wireless LAN uses radio waves in the 5 GHz bands.

Be sure to read and fully understand the following items before use.

Use this product indoors.

- Using the 5 GHz-band wireless device outdoors is prohibited by the Radio Act.

If at all possible, avoid the use of cellular phones, TV sets or radios near the product.

- Cellular phones, TV sets, radios and similar devices use different radio bands from the product, so there is no effect on wireless communication or the transmission and reception of these devices. However, radio waves from the product may produce audio or video noise.

Wireless communication radio waves cannot penetrate steel reinforcements, metal, concrete, etc.

- Communication is possible through walls and floors made from materials such as wood and glass (except glass containing wire mesh), but not through walls and floors made from steel reinforcements, metal, concrete, etc.

The product may not work properly due to strong radio wave from the broadcast station or the radio.

- If there is any facility or equipment, which outputs strong radio wave, near the installation location, set up the product at a location sufficiently far from the source of the radio wave.

Using the product outside the country

- It is forbidden to take the product outside the country or region where you purchased it, so use it only in the said country or region. Also, note that depending on countries or regions there are restrictions on the channels and frequencies at which you can use the wireless LAN.

Declaration of Conformity (DoC)

"Hereby, Panasonic Connect Co., Ltd. declares that this product is in compliance with the essential requirements and other relevant provisions of the Directive 2014/53/EU."

If you want to get a copy of the original DoC of this product, please visit the following website:

<http://www.ptc.panasonic.de>

Authorized Representative:

Panasonic Testing Centre

Panasonic Service Europe, a division of Panasonic Connect Europe GmbH

Winsbergring 15, 22525 Hamburg, Germany

Indoor use restrictions are to be followed for the following countries if using 5 GHz frequency band.

Austria, Belgium, Bulgaria, Croatia, Cyprus, Czech Republic, Denmark, Estonia, Finland, France, Germany, Greece, Hungary, Iceland, Ireland, Italy, Latvia, Liechtenstein, Lithuania, Luxembourg, Malta, Netherlands, Norway, Poland, Portugal, Romania, Slovakia, Slovenia, Spain, Sweden, Switzerland, Turkey, United Kingdom

WLAN: Maximum Power

23 dBm (5.180 GHz - 5.240 GHz)

Directive: 2014/53/EU

Request Regarding Security

When using this product, take safety measures against the following incidents.

- Personal information being leaked via this product
- Unauthorized operation of this product by a malicious third party
- Interfering or stopping of this product by a malicious third party

Take sufficient security measures.

Precautions on security when using wireless LAN products

- The advantage of a wireless LAN is that information can be exchanged between a PC or other such equipment and an access point using radio waves as long as you are within range for radio transmissions. On the other hand, because the radio waves can travel through obstacles (such as walls) and are available everywhere within a given range, problems of the type listed below may occur if security-related settings are not made.
 - A malicious third-party may intentionally intercept and monitor transmitted data including the content of e-mail and personal information such as your ID, password, and/or credit card numbers.

- A malicious third-party may access your personal or corporate network without authorization and engage in the following types of behaviour.

Retrieve personal and/or secret information (information leak)

Spread false information by impersonating a particular person (spoofing)

Overwrite intercepted communications and issue false data (tampering)

Spread harmful software such as a computer virus and crash your data and/or system (system crash)

- Since most wireless LAN adaptors or access points are equipped with security features to take care of these problems, you can reduce the possibility of these problems occurring when using this product by making the appropriate security settings for the wireless LAN device.
- Some wireless LAN devices may not be set for security immediately after purchase. To decrease the possibility of occurrence of security problems, before using any wireless LAN devices, be absolutely sure to make all security-related settings according to the instructions given in the operation manuals supplied with them.

Depending on the specifications of the wireless LAN, a malicious third-party may be able to break security settings by special means.

If you cannot perform security settings for your wireless LAN by yourself, please contact the Panasonic dealer.

- Panasonic Connect Co., Ltd. asks customers to thoroughly understand the risk of using this product without making security settings, and recommends that the customer make security settings at their own discretion and responsibility.

Specifications

Model No.	TY-SB01WP
Product name	Wireless Presentation System Receiver Board
Video output	HDMI × 1 (HDCP1.4)
Output resolution	1920 x 1080/60p, 3840 x 2160/30p (max.)
Number of simultaneous connections	32
Wireless communication standard	IEEE802.11a/n/ac Bluetooth (GFSK, π/4-DQPSK, 8DPSK)
Data rate wireless	867 Mbps (max.)
Frequency band	5 GHz (5.150 GHz to 5.250 GHz)
Security	WPA/WPA2
Reachable distance	Up to 30 m (Locations with good visibility and radio wave conditions)
FUNCTION LED	
White blinking	Pairing in progress
White illumination	Pairing complete
LAN terminal	RJ45 × 1 10BASE-T/100BASE-TX/ 1000BASE-T supported
USB terminal	USB connector × 1, Type-A
Dimensions (W × H × D)	82 mm × 25 mm × 122 mm / 3.22" × 0.99" × 4.78" (excluding antennas)
Mass	Approx. 125 g / 0.3 lbs

Software License

This product incorporates the following software:

- (1) the software developed independently by or for Panasonic Connect Co., Ltd.,
- (2) the software owned by third party and licensed to Panasonic Connect Co., Ltd.,
- (3) the software licensed under the GNU General Public License, Version 2.0 (GPL V2.0),
- (4) the software licensed under the GNU LIBRARY General Public License, Version 2.0 (LGPL V2.0),
- (5) the software licensed under the GNU LESSER General Public License, Version 2.1 (LGPL V2.1), and/or
- (6) open source software other than the software licensed under the GPL V2.0, LGPL V2.0 and/or LGPL V2.1.

The software categorized as (3) - (6) are distributed in the hope that it will be useful, but WITHOUT ANY WARRANTY, without even the implied warranty of MERCHANTABILITY or FITNESS FOR A PARTICULAR PURPOSE. For details, see the license conditions displayed by selecting [Software licenses], following the specified operation from the Web setting screen of this product.

At least three (3) years from delivery of this product, Panasonic Connect Co., Ltd. will give to any third party who contacts us at the contact information provided below, for a charge no more than our cost of physically performing source code distribution, a complete machine-readable copy of the corresponding source code covered under GPL V2.0, LGPL V2.0, LGPL V2.1 or the other licenses with the obligation to do so, as well as the respective copyright notice thereof.

Contact Information:

oss-cd-request@gg.jp.panasonic.com

FCC STATEMENT

This equipment has been tested and found to comply with the limits for a Class B digital device, pursuant to Part 15 of the FCC Rules. These limits are designed to provide reasonable protection against harmful interference in a residential installation. This equipment generates, uses and can radiate radio frequency energy and, if not installed and used in accordance with the instructions, may cause harmful interference to radio communications.

However, there is no guarantee that interference will not occur in a particular installation. If this equipment does cause harmful interference to radio or television reception, which can be determined by turning the equipment off and on, the user is encouraged to try to correct the interference by one or more of the following measures:

- Reorient or relocate the receiving antenna.
- Increase the separation between the equipment and receiver.
- Connect the equipment into an outlet on a circuit different from that to which the receiver is connected.
- Consult the dealer or an experienced technician for help.

FCC CAUTION:

To assure continued compliance, follow the attached installation instructions and use only the provided power supply cord. Any changes or modifications not expressly approved by Panasonic Corp. of North America could void the user's authority to operate this device.

FCC RF Exposure Warning:

- **This transmitter complies with FCC radiation exposure limits set forth for an uncontrolled environment for mobile use with minimum 8 inches (20 cm) spacing requirement between transmitter and all person's body (excluding extremities of hands, wrist and feet) during wireless modes of operation.**

<Only for wireless LAN if capable of transmission in the 5.18 ~ 5.24 GHz frequency band>

This product is restricted to indoor use due to its operation in the 5.18 to 5.24 GHz frequency range.

Supplier's Declaration of Conformity

Model No.

TY-WPR1, TY-WPB1, TY-WPBC1

Responsible Party:

Panasonic Corporation of North America
Two Riverfront Plaza, Newark, New Jersey
07102-5490

Contact Source:

Panasonic Connect North America
1-877-655-2357

General Contact:

<http://shop.panasonic.com/support>

This device complies with Part 15 of the FCC Rules.

Operation is subject to the following two conditions: (1)

This device may not cause harmful interference, and (2) this device must accept any interference received, including interference that may cause undesired operation.

Panasonic Connect North America
Division of Panasonic Corporation of North America
Two Riverfront Plaza
Newark, NJ 07102

**PANASONIC PROFESSIONAL DISPLAY
WIRELESS PRESENTATION SYSTEMS
Limited Warranty**

Models or Parts	Part Warranty	Labor Warranty
TY-WPS1, TY-SB01WP, TY-WP2B1, TY-WPB1, TY-WPSC1, TY-WP2BC1, TY-WPBC1	3 Years	3 Years
Exceptions		
All Panasonic accessories: e.g. power adapter, batteries, etc.	1 Year	1 Year

Panasonic Connect North America (referred to as “the Panasonic”) will repair the Professional Display product (the “Product”) and its accessories as defined in the attached table, with new or refurbished parts, free of charge in the continental USA, during the applicable warranty coverage period from the original date of purchase in the event of a defect in materials or workmanship as follows: advanced replacement with a refurbished product with like conditions within the **continental USA** may be obtained during the warranty period by contacting Panasonic’s Technical Support Center at the following toll free number **855-772-8324** or via e-mail; ProDisplaySupport@us.panasonic.com. Panasonic will pay for the all transportation of

the exchange Product to the customer. For out of warranty Product units submitted for repairs or for in warranty units submitted by customers outside of the continental USA, shipping arrangements and cost (both ways) are the customer’s responsibility. Panasonic will also not be responsible for any costs associated with determining the source of system problems or for removing and installing the faulty Product.

This warranty is extended only to the original purchaser and is nontransferable. A purchase receipt or other proof of date of original purchase will be required before warranty service is rendered. Whenever the date of original purchase cannot be satisfactorily determined, the date of manufacture of the unit will be deemed to be the effective date of the warranty. Panasonic reserves the right to audit and reject any warranty claim that cannot be substantiated. This warranty only covers failures due to defects in materials or workmanship which occur during normal use of the Product.

The warranty **DOES NOT** cover damage to the display and its components which occur in shipping; failures which are caused by products not supplied by Panasonic; failures which result from accident, misuse, abuse, neglect, mishandling, misapplication, alteration, modification, faulty installation, setup adjustments, improper antenna, inadequate signal pickup, maladjustment of user controls, improper operation, power line surge, improper voltage supply, lightning damage, smoke or chemical vapors contamination, air conditioning, humidity control or other environmental conditions; failure to maintain the product in accordance with the applicable Operating Instructions; service by anyone other than an authorized repair facility; damage that is attributable to acts of violence, war, acts of God or force majeure.

The warranty does not cover units of which the model and serial number label has been defaced, modified, tampered with or removed. The warranty does not cover consumable parts.

LIMITS AND EXCLUSIONS

PANASONIC SHALL NOT BE LIABLE FOR ANY INDIRECT, INCIDENTAL, CONSEQUENTIAL, PUNITIVE OR SPECIAL DAMAGES, INCLUDING, BUT NOT LIMITED TO, LOSS OF DATA, LOSS OF PROFIT, LOSS OF REVENUE, OR LOSS OF BUSINESS OR GOODWILL, SUFFERED BY ANY PERSON, AND RESULTING FROM THE USE OF THIS PANASONIC PROFESSIONAL DISPLAY PRODUCT, OR ARISING OUT OF ANY BREACH OF THIS WARRANTY. ALL EXPRESS WARRANTIES SPECIFIED ABOVE ARE IN LIEU OF ALL OTHER WARRANTIES, EXPRESS, IMPLIED OR STATUTORY, INCLUDING BUT NOT LIMITED TO, THE IMPLIED WARRANTIES OF MERCHANTABILITY AND FITNESS FOR A PARTICULAR PURPOSE

Some states do not allow the exclusion or limitation of incidental or consequential damages, or limitations on how long an implied warranty lasts, so the above limitations or exclusions may not apply to you.

If you have a problem with this product that is not handled to your satisfaction, then write the Consumer Affairs Department at the Panasonic's address indicated above.

Trademark Credits

- HDMI, High-Definition Multimedia Interface and the HDMI Logo are trademarks or registered trademarks of HDMI Licensing Administrator, Inc. in the United States and other countries.
- USB Type-C and USB-C are trademarks or registered trademarks of USB Implementers Forum.
- PressIT is a trademark of Panasonic Holdings Corporation.

Even if no special notation has been made of company or product trademarks, these trademarks have been fully respected.

Disposal of Old Equipment Only for European Union and countries with recycling systems



This symbol on the products, packaging, and/or accompanying documents mean that used electrical and electronic products must not be mixed with general household waste.

For proper treatment, recovery and recycling of old products, please take them to applicable collection points in accordance with your national legislation.

By disposing of them correctly, you will help to save valuable resources and prevent any potential negative effects on human health and the environment.

For more information about collection and recycling, please contact your local authority.

Penalties may be applicable for incorrect disposal of this waste, in accordance with national legislation.

Notice (U.S.A. only)

Disposal may be regulated in your community due to environmental considerations. For disposal or recycling information, please visit Panasonic website:

<https://www.panasonic.com/us/corporate/sustainability.html>

or call 1-888-769-0149.

Customer's Record

The model number and serial number of this product may be found on its rear panel. You should note this serial number in the space provided below and retain this book, plus your purchase receipt, as a permanent record of your purchase to aid in identification in the event of theft or loss, and for Warranty Service purposes.

Model Number

Serial Number

Panasonic Connect North America

Unit of Panasonic Corporation of North America

Executive Office :

Two Riverfront Plaza, Newark, New Jersey 07102

Authorized Representative in EU:

Panasonic Connect Europe GmbH

Panasonic Testing Centre

Winsbergring 15, 22525 Hamburg, Germany

Importer for UK:

Panasonic Connect UK,

a branch of Panasonic Connect Europe GmbH,

Maxis 2, Western Road, Bracknell, Berkshire, RG12 1RT

Panasonic Connect Co., Ltd.

4-1-62 Minoshima, Hakata-ku, Fukuoka 812-8531, Japan

Web Site: <https://panasonic.net/cns/prodisplays/>

© Panasonic Connect Co., Ltd. 2022

English

Printed in China